

**PUBLIC EDUCATION
IN VALLEY STREAM
NEW YORK
DURING THE
TWENTIETH CENTURY**

**VOLUME
XVIII**

**VSUFSD Thirty
Calendars**

by
William P. Stris

This project is dedicated to:

PETER K. STRIS

Father	1905 - 1982
Brother	1942 - 1962
Son	1975 -

and
EMILIE

Public Education in Valley Stream, New York, During the Twentieth Century

TABLE OF CONTENTS

VOLUME Zero

	Dedication
	Thucydides, History of the Peloponnesian War
	District Thirteen Seal
	District Thirteen, Twenty-four and High School Logo
	Table of Contents
	Instructional Service Center of the VSCHSD
	Valley Stream Historical Society official Emblem
	General Introduction to entire work
Preface	
Pre-Revolution	
New York State	
Valley Stream School District Thirteen	
Valley Stream School District Twenty-four	
Valley Stream School District Thirty	
Valley Stream Central High School District No. 1	
Appendix I	History of Valley Stream by Robert M. Dibble - 1928
Appendix II	Educational Development of Valley Stream
Appendix III	Salvation Army's Wayside Home for Girls
Appendix IV	Franklin General Hospital
Appendix V	Religious Institutions in Valley Stream
Appendix VI	Valley Stream Historical Society Newsletters - PANORAMA
Appendix VII	Historical Timeline of Valley Stream, New York
Appendix VIII	DVDs of entire project ¹

VOLUME IA

Valley Stream Union Free School District Thirteen **History**

Thucydides, History of the Peloponnesian War

¹ One copy of Volume Zero, which contain DVDs of the entire project, were donated to every Public School Library in Valley Stream and 1) Hofstra University – Long Island Studies Institute, Special Collections 123 Hofstra University Hempstead, NY 11549; 2) the Valley Stream Historical Society at the Pagan/Fletcher House located at 143 Hendrickson Avenue Valley Stream, NY 11580; 3) the Valley Stream Henry Waldinger Memorial Library at 60 Verona Place Valley Stream, NY 11582; 4) the offices of the Valley Stream Union Free School District Thirteen at 585 North Corona Avenue Valley Stream, NY 11580; and 5) the offices of the Valley Stream Central High School District at One Kent Road, Valley Stream, NY 11580-3398.

i
ii
iii

Dedication
Valley Stream UFSD Thirteen Schools
District Seal
District Logo
Table of Contents
Instructional Service Center of the VSCHSD
Valley Stream Historical Society official Seal
Letters

Preface
Chapter One Introduction
Chapter Two The District Through the Decades

VOLUME I_B

Chapter Two The District Through the Decades
Chapter Three The District Boundary Lines
Chapter Four Land Purchase and Buildings
Chapter Five Transportation
Chapter Six Consolidation/Centralization
Chapter Seven Valley Stream Teachers' Association (VSTA)
Chapter Eight Parent Teacher Association (PTA)
Chapter Nine Joint Meetings of the Valley Stream Boards
Chapter Ten Valley Stream State Park
Chapter Eleven Civic Association
Chapter Twelve Summertime

VOLUME I_C

Appendix I Board of Education Members
Appendix II Past Presidents of School Board
Appendix III School Board Hall of Fame
Appendix IV Administration
Appendix V Board of Education Election Results
Appendix VI Budgets and Propositions
Appendix VII Public Attendance at Board Meetings
Appendix VIII VSUFSD 13 Educational Foundation
Appendix IX Assessed Valuation, Tax Rate - Each District
Appendix X The Growth of School District 13
Appendix XI Tax Exempt Property in District Thirteen
Appendix XII Organizations that Use District Thirteen Schools

VOLUME II A, B, C, D, E, F

Valley Stream Union Free School District Thirteen
Scrapbook

VOLUME III

Valley Stream Union Free School District Thirteen
Yearbooks

VOLUME IV

Valley Stream Union Free School District Thirteen
Calendar of Events

VOLUME V
Valley Stream Union Free School District Thirteen
Newsletters

VOLUME VIA & B
Valley Stream Union Free School District Thirteen
PTA Newsletters

VOLUME VII
Valley Stream Union Free School District Thirteen
Closing Exercise Programs

VOLUME VIIIA
Valley Stream Union Free School District Twenty - Four
History

	Thucydides, History of the Peloponnesian War
	Dedication
	Valley Stream UFSD Twenty-Four Schools
	District Logo
	Table of Contents
	Instructional Service Center of the VSCHSD
	Valley Stream Historical Society official Seal
i	
ii	
Preface	
Chapter One	Introduction
Chapter Two	The District Through the Decades
Chapter Three	The District Boundary Line
Chapter Four	Land Purchase and Building
Chapter Five	Transportation
Chapter Six	Consolidation/Centralization
Chapter Seven	Valley Stream Teachers' Association (VSTA)
Chapter Eight	Parent Teacher Association (PTA)
Chapter Nine	Joint Boards of Education

VOLUME VIIIB

Appendix I	Board of Education Members
Appendix II	Past Presidents of School Board
Appendix III	School Board Hall of Fame
Appendix IV	Administration
Appendix V	Board of Education Election Results
Appendix VI	Budgets and Propositions
Appendix VII	Assessed Valuation, Tax Rate
Appendix VIII	Gibson At A Glance 1965 Edition
Appendix IX	Tax Exempt Property in District Twenty-Four
Appendix X	Historic Property Paper: Brooklyn Avenue School

VOLUME IX
Valley Stream Union Free School District Twenty - Four
Scrapbook

VOLUME X
Valley Stream Union Free School District Twenty - Four
Yearbooks

VOLUME XI
Valley Stream Union Free School District Twenty - Four
Family Handbook

VOLUME XII
Valley Stream Union Free School District Twenty - Four
Newsletters

VOLUME XIII
Valley Stream Union Free School District Twenty - Four
PTA Newsletters

VOLUME XIV
Valley Stream Union Free School District Twenty-Four
Closing Exercise Programs

VOLUME XV
Valley Stream Union Free School District Thirty
History

	Thucydides, History of the Peloponnesian War
	Dedication
	Valley Stream UFSD Thirty Schools
	Table of Contents
i	Instructional Service Center of the VSCHSD
ii	Valley Stream Historical Society official Seal
iii	Valley Stream UFSD 30 State of N.Y. Corporate Seal
Preface	
Chapter One	Introduction
Chapter Two	The District Through the Decades
Chapter Three	The District Boundary Line
Chapter Four	Land Purchase and Building
Chapter Five	Transportation
Chapter Six	Consolidation/Centralization
Chapter Seven	Valley Stream Teachers' Association (VSTA)
Chapter Eight	Parent Teacher Association (PTA)
Chapter Nine	Joint Boards of Education
Appendix I	Board of Education Members
Appendix II	Past Presidents of School Board
Appendix III	School Board Hall of Fame
Appendix IV	Administration
Appendix V	Board of Education Election Results
Appendix VI	Budgets and Propositions
Appendix VII	Assessed Valuation, Tax Rate

VOLUME XVI

Valley Stream Union Free School District Thirty
Scrapbook

VOLUME XVII A & B

Valley Stream Union Free School District Thirty
Yearbooks

VOLUME XVIII A & B

Valley Stream Union Free School District Thirty
Calendars

VOLUME XIX A & B

Valley Stream Union Free School District Thirty
Newsletters

VOLUME XX

Valley Stream Union Free School District Thirty
PTA Newsletters

VOLUME XXI

Valley Stream Union Free School District Thirty
Closing Exercise Programs

VOLUME XXII A & B

Valley Stream Central High School District
History

- Thucydides, History of the Peloponnesian War
- Dedication
- Valley Stream CHSD Schools
- Table of Contents
- District Logo and Seal
- Instructional Service Center of the VSCHSD
- Valley Stream Historical Society official Seal

i
ii

Preface

Introduction The Structure of the New York State School System

Chapter One Central High School Districts – Past and Present

Chapter Two The Legal Foundations of a Central High School District

Chapter Three The High School District Through the Decades

The 1920s and 1930s:

- Clock Tower/Swimming Pool
- Central High School Auditorium
- The Athletic Association
- District Orchestra
- District and School Newspaper
- The School Rifle Range

The 1940s and 1950s:

- Valley Stream Teachers Federal Credit Union
- Recreational Use by the District and Village of Valley Stream
- Administrative Assistant
- Extra Pay for Extra Services
- Exchange Students
- Military Service
- Music Program
- Transportation
- Fraternities and Sororities
- Commencement Exercises

The 1960s and 1970s:

- Civil Defense
- Lights on for Education
- Building Inspection Tour
- Library Services
- Open Campus/Closed Lunch
- Student Activism
- Declining Enrollment
- Desegregation Lawsuits

The 1980s and 1990s:

- District Dedication Sites
- Featured Teachers
- Class Size and Staff Survey
- Distance Learning Program
- Distinguished Alumni Award Program
- AIDS Instruction
- Closed Lunch
- Restructuring the District
- 1998 Bond Issue
- New Higher Educational Standards

Chapter Four Land Purchase and Buildings

Chapter Five The PTSA and Other School organizations

Chapter Six Enrollment

Chapter Seven VSTA

Chapter Eight Consolidation/Centralization

Chapter Nine Joint Meetings of the Valley Stream Boards

Appendix I Petition of Qualified Electors

Appendix II Central High School Yearbook – 1927 Class History

Appendix III History of the Central High School District

Appendix IV Board of Education Members

Appendix V Administration

Appendix VI Past Presidents of the Board of Education

Appendix VII School Board Hall of Fame

Appendix VIII Budget

Appendix IX Propositions

Appendix X Distinguished Alumni Awards

Appendix XI Athletic Awards and Sports Dinner

VOLUME XXIII

**Commencement Programs from Central, North and South High Schools
Summer School Commencement Programs²**

VOLUME XXIV

Valley Stream Central High School District
Directory and Calendars

VOLUME XXV A and B

(1956 to 2000)

Valley Stream Central High School District
Newsletters (The Observer)

VOLUME XXVI

Valley Stream Central High School District
PTSA Newsletters

Illustrations/Photos and Primary Source material

Volume Zero

District Seals	
District Logos	
Thucydides	
Instructional Service Staff (ISC)	i
Valley Stream Historical Society official Emblem	ii

Chapter One (Introduction)

Chapter Two (General history of Valley Stream)

Chapter Three (Brief history of Valley Stream Schools)

Appendix I (History of Valley Stream by Robert M. Dibble – 1928)

Appendix II (Educational Development of Valley Stream)

Appendix III (Salvation Army's Wayside Home for Girls)

Photos of Wayside buildings	pp. 5 to 9
Aerial map of property	pp. 29, 30
Construction photos of homes	pp. 37 to 113

Appendix IV (Franklin General Hospital)

Photos of hospital events	pp. 22 to 29
---------------------------	--------------

Appendix V (Religious Institutions in Valley Stream)

Photos of Religious Institutions	pp. 10 to 75
Map of Religious Institutions in valley Stream	p. 76

Appendix VI (Valley Stream Historical Society Newsletters - PANORAMA)

Volume I

Chapter One (Introduction)

Robert and Ellen Pagan	p.21
Sinners Hope Chapel	p.22
Two room Schoolhouse – 1891	p. 23
Old Wooden District 13 Schoolhouse - 1905	p. 23, 24

² See also Public Education in Valley Stream, Supra note 2, Volume XXVB VSCHSD Newsletter, The Observer September/October 1999 Vol. 33, No. 5 at 5. Photo and list of Summer School graduates.

Culvert and Wash Gate in Culvert - 1874	p. 25
Bridge at head of Valley Stream Pond - 1874	p. 26
Carman's Mill – 1874	p. 27
Pond above Carman's Mill – 1874	p. 28
Gatehouse at Pines Pond – 1878	p.p. 29 30, 31
Pines Pond – 1879	p. 32
Pond above Carman's Mill – 1879	p. 33
Mill on Watt's Pond – 1880	p. 34
Pines Pond – 1880	p. 35
Pumping Station at Smith's Pond – 1880	p. 36
Herrick's School – 1898	p. 37
Mineola Fair – 1910	p. 38
Glenn Hammond Curtiss – 1912	p. 38
Valley Stream Railroad Station – ca 1910	p. 39
Valley Stream Railroad Station	p. 38a
Valley Stream Railroad Station - 1916	p. 38b
Valley Stream Railroad Station - 1928	p. 38c
Valley Stream Railroad Station -	p. 38d
Valley Stream Railroad Station	p. 39
Nassau County Parade – 1920	pp. 40, 41
Corona Avenue Volunteer Fire Department Parade – 1901	p. 42
Valley Stream Fire House – 1912	p. 43
Joseph F. Felton, Grocer and Seedman Store – ca 1910	p. 44
Joseph Golder's Blacksmith Shop	p. 45
Valley Stream Supply Pond	p. 45
Valley Stream Gate and Spillway	p. 45
Watt's Pond	p. 45
Ridgewood Aqueduct	p. 46
Valley Stream Trolley - 1903-1926	p. 46
Arthur J. Hendrickson – 1900-1910	p. 47
Smith Stringham's Farm	p. 48
Stick's Farm – 1880	p. 48
Aulis Finn's house	p. 48
Frank Stick and Son Market Truck	p. 48
Elbert Golder and Delivery wagon – 1910	p. 49
Queensboro Gas and Electric Company Car – 1922	p. 49
Copies Hotel – 1900	p. 50
Brun's Hotel – 1900	p. 50
196 Rockaway Avenue, Valley Stream - 2005	p. 50a
24 Rockaway Avenue – Sal and Vin's Barber Shop - 2005	p. 50b
Ariel view of Valley Stream	p. 51
Map of Brooklyn and Queens - 1843	p. 53
Map of Valley Stream	p. 54
Map of Valley Stream and Area - 1886	p. 55
Map of Valley Stream	p. 57
Map of Valley Stream - 1891	p. 58
Map of Valley Stream School District 13	p. 59
Map of Attendance area of the Willow Road School – 1980	p. 60
Map of Election Districts in the Town of Hempstead – 1894	p. 61
Map of Town Line between Jamaica and Hempstead - 1846	p. 62
Map of the Queens-Nassau Border Area - 1999	p. 63
Referendum Vote in Greater NY – 1894	p. 64
Master Plan of School District Reorganization - 1943	p. 65, 66
Master Plan Key – 1943	p. 67
Stagecoach - ca. 1850	p. 68
Rum Junction in Valley Stream – 1880	p. 68

Valley Stream – ca. 1890	p. 69
Merrick Road – ca. 1920	p. 69
Valley Stream – ca. 1923	p. 70
Rio Movie Theater – ca. 1920	p. 70
Valley Stream Movie Theater – just prior to being demolished	pp. 70 a, b, c & d
Valley Stream Golf Club – ca. 1930	p. 71
Merrick Road – ca. 1930	p. 72
Valley Stream Library – ca. 1930	p. 72, 73
Valley Stream Park Inn – ca. 1940	p. 73
Valley Stream Central High School Marching band – ca. 1930	p. 74
Southern State Parkway toll – ca. 1975	p. 75
Valley Stream Masonic Lodge Building - 2004	p. 76
Valley Stream Masonic Square Club in Parade	p. 76a
Valley Stream Masonic Lodge Building – 2005	pp. 77 to 80
Valley Stream Elks Lodge No. 1 at West Jamaica Avenue – 2005	pp. 80a & b
Pagan-Fletcher Restoration brochures – ca. 2000	p. 81
Queens Library Brochure - Long Island Division	p. 83
Map of Valley Stream – 1980	p. 84
Pagan-Fletcher Restoration Brochure	p. 85
Valley Stream Map - 1880	p. 86
Listing of Families living in Valley Stream – ca, 1880	p.87
Map of Valley Stream - 1873	pp. 88, 89
Map of Nassau County Indicating School Districts – 1873	pp. 90 to 93
Town of Hempstead Map Showing School District Boundaries – 1903	p. 93
VSUFSD Thirteen Map – 1992	p. 94
Map of Attendance Zone for the Robert W. Carbonaro School	p. 95
Map of Attendance Zone for the William L. Buck School	p.96
Map of Attendance Zone for the Brooklyn Avenue School	p. 97
Map of Attendance Zone for the Forest Road School	p. 98
Map of Attendance Zone for the Clear Stream Avenue School	p. 99
Map of Attendance Zone for the Shaw Avenue School	p. 100
Map of Attendance Zone for the entire Elementary District	p. 101
Photos of Merrick Road in Valley Stream	pp.103 to 161
Photos of Corona Avenue in Valley Stream	pp. 163 to 197
Photos of Rockaway Avenue in Valley Stream	pp. 198 to 242
Photos of North Franklin Avenue in Valley Stream	pp. 243 to 281
Photos of Mill Road and Central Avenue in Valley Stream	pp. 282 to 342
Photos of Franklin Avenue in Valley Stream	pp. 343 to 386
Photos of Hendrickson Avenue in Valley Stream	pp. 387 to 414
Photos of Wheeler Avenue in Valley Stream	pp. 415 to 442
Photos of Emerson Place in Valley Stream	pp. 443 to 481
Photos of Meachan Avenue in N. Valley Stream	pp. 482 to 496
Photos of Dutch Broadway in N. Valley Stream and Elmont	pp. 497 to 524
Photos of Sunrise Highway in Valley Stream	pp. 525 to 562

Chapter Two (Through the Decades)

Pre Twentieth Century

The Algonquians of Long Island	p. 19
Photocopy of the pages recording the first School District Boundaries	pp. 20 to 23
Town of Hempstead First School Districts	pp. 24 to 30
Document dated July 4, 1657	p. 30a
The Ambrose Sutton Bill of Sale for Valley Stream in 1661	pp. 30c & d
Copies of original Town of Hempstead and State Education Department documents relating to the Valley Stream Schools	pp. 31 to 298
Eighteenth and early 19th century newspaper articles on Valley Stream and its Schools	pp. 299 to 339

Valley Stream School District Thirteen Enrollment Graph – 1821 to 1848	pp. 340 to 344
Valley Stream Water works, west side of Mill Road	p. 345
Mr. Rountin owner of Gas Station delivering Kerosene	p. 346
Blacksmith shop at West Merrick Road and Central Avenue, ca. 1898	p. 347
At Clear Stream Pumping Station looking west	p. 348
Clear Stream looking north, east from near pump station & valley Stream at	p. 349
Second Street looking east across Y Branch to Far Rockaway	p. 349
Henry Hendrickson in front of his house, built around 1870. Corner of	p. 350
Hendrickson and Henry Street	
The Stick Farm House at North Central Avenue	p. 351
City Line from Hook Creek Pump Station looking east	p. 352
Farm House on North Central Avenue	p. 353
Finn's farm House at North Central Avenue	p. 354
Engine Company No. 1, Merrick Road between Franklin and Corona Avenue	p. 355
Valley Stream Hotel, Rockaway Avenue at the Long Island Rail Road	p. 356
Entrance to Pavilion Royal on Merrick Road	p. 357
Rockaway Parkway and Melrose Street looking South	p. 358
Rockaway Avenue South, looking North East across Park	p. 359
Joseph Golder Blacksmith Shop on West Merrick Road about 1900	p. 360
Sagamore Hotel, Rockaway at Long Island Railroad	p. 361
Landgrebe Hotel	p. 362
Henry Keller residence at Corona Avenue	p. 363
Pharmacy, ca. 1880	p. 364
The Iceman, Rockville Centre, ca. 1870	p. 365
Interior, Grocery Store, ca. 1885	p. 366
Haycutting, Westbury, ca. 1885	p. 367
Old Queens County Courthouse near Mineola, ca. 1890	p. 368
Queens County Agricultural Society Judges at the Mineola Fair, ca. 1895	p. 369
Nassau County Jury, Mineola, ca. 1899	p. 370
<i>The Teens and Twenties</i>	
Neighborhood School Room – ca, 1920	p. 11
Wheeler Avenue School – 1928	p. 12
PTA Minstrel Show brochure – 1927	pp. 13, 14
Wheeler Avenue School Post Card	p. 15
Hoffman's Pavilion – 1920s –	p. 16
Thomas West's Hotel showing contestants of bicycle marathon race on July 5, 1907	p. 17
School desk and Chair - 1920	p. 18
Buck Farm House - ca, 1900	p. 19
Landgrebe Hotel, 1900	p. 20
Woods Avenue School, East Rockaway, Ca 1900	p. 21
Cabbage Wagon, 1905	p. 22
Lynbrook, 1906	p. 23
Luca's Hotel, 1910	p. 24
Hewlett Brothers, Woodmere, ca. 1915	p. 25
William Mills House, 1918	p. 26
Valley Stream Lakes and Streams – Post Cards	p. 27
Victor Moore and His "Klever Komedies," ca. 1917	p. 28
Augustine's Pansy Farm, located on Horton Avenue and Rockaway Avenue, ca. 1920	p. 29
Bill Lingner owner of Hupmobile Car Agency	p. 30
Hupmobile Car Agency at East Merrick Road and North Grove Street, ca 1926	p. 31
Valley Stream Police Department, 1929	p. 32
<i>The Thirties</i>	
Wheeler Avenue School Second Grade - 1931	p.12
Wheeler Avenue School Third Grade - 1932	p. 13

Wheeler Avenue School Sixth Grade – 1933	p. 14
Names of Wheeler Avenue School Sixth graders – 1933	p. 15
Wheeler Avenue School Graduating Class - 1935	p. 16
Names of Wheeler Avenue Graduates – 1935	p. 17
Wheeler Avenue School Graduating Class – 1936	p.18
Rockaway Avenue looking North to East Fairview Avenue - May 1931	p. 19
Rockaway Avenue at Hawthorne Avenue looking South to the Long island Rail Road Crossing - 1931	p. 20
Early Park Inn at Merrick Road looking East - 1932	p.21
Wheeler Avenue School Second Grade - 1931	p. 23
Aerial view of Valley Stream, Curtiss-Write Flying Service, ca. 1945	p. 24
Opening Night First Drive-In Theater Sunrise Highway V. S. - August 16, 1938	p. 25
Hotel Pitney on Rockaway Avenue – 1938	p. 26

The Forties

Mrs. May Parrish with Valley Stream Sunrise Drive-In Movie Theater	p. 6
Rockaway Avenue looking South from Jamaica Avenue - March 6, 1943	p. 7
Tally-Ho Hotel at Merrick Road and Horton Avenue	p. 8
Wheeler Avenue School Fifth Grade – 1947	p. 9
Club Esquire Night Club Franklin Avenue and Wheeler Avenue - September 3, 1948	p. 10
Phil Datz's Town Tavern 371 Rockaway Ave. off Sunrise Highway November 13, 1947	p. 11
Rockaway Avenue looking north to Municipal Building - Winter 1942	p. 12
Rockaway Avenue from roof of Municipal Building looking south - March 6, 1943	p. 13
Valley Stream Baseball Team at Grant Park - April 27, 1940	p. 14

The Fifties

Willow Road School – 1952	p. 9
First Grade at Corona Avenue School – 1952-53	p. 10
Kindergarten at Corona Avenue School – 1952-53	p. 11
Third Grade at Wheeler Avenue School – 1952-53	p. 12
Fifth Grade at Corona Avenue School – 1952-53	p. 13
Sixth Grade at Wheeler Avenue School – 1952-53	p. 14
The Chunky Continuum playground equipment – 1966	p. 15
Chunky Candy at World's Fair – 1964	p. 16
Corona Avenue School Library – 1952-53	p. 17
Second Grade at Corona Avenue School – 1952-53	p. 18
Kindergarten at the Corona Avenue School – 1959	p. 19
Fifth Grade at Corona Avenue School – 1959	p. 20
Willow Road PTA (Executive Board Members) – 1955-56	p. 21
Kindergarten at Willow Road School – 1956	p. 22
Kindergarten at the Willow Road School – 1956	p. 23
Kindergarten at the Willow Road School – 1956	p. 24
Kindergarten at the Willow Road School – 1956	p. 25
Second Grade at the Corona Avenue School – 1952-53	p. 26
Library at the Corona Avenue School – 1952-53	p. 27
Wheeler Avenue School Faculty – 1952-53	pp. 28, 29
Budget Voting Graph from 1949 to 1959	p. 31
Photo of Wheeler Avenue School – 1952-53	p. 32
Letter from Architect	p. 33
Howell Road School – 1952	pp. 34 to 37
Willow Road School – 1952	pp. 38 to 41
Rockaway Avenue looking north to Mineola Avenue - October 25, 1952	p. 42
Merrick Road looking west to Cornwell Avenue - October 26, 1952	p. 43

The Sixties

Corona Avenue School Children – 1960	p. 17
First Grade at Corona Avenue School – 1962	p. 18
PTA Honor Class at Corona Avenue School – 1967	p. 19
Corona Avenue School – 1960	p. 20
First Grade at the Corona Avenue School - 1960	p. 21
First Grade at the Corona Avenue School - 1960	p. 22
Second Grade at the Corona Avenue School - 1960	p. 23
Fourth Grade at the Corona Avenue School – 1960	p. 24
Sixth Grade at the Corona Avenue School – 1960	p. 25
Kindergarten at the Corona Avenue School – 1962	p. 26
Entrance Green Acres Shopping Center Sunrise Highway - 1961	p. 27
Chef's Diner West Merrick Road - August 13, 1966	p. 28
<i>The Seventies</i>	
Wheeler Avenue Faculty-Student Kickball Game – April 1978	pp. 12, 12a
Corona Avenue School Faculty – 1975-76	p. 13
First Grade at Corona Avenue School – 1970-71	p. 14
Second Grade at the Corona Avenue School – 1971-72	p. 15
Sixth Grade at Corona Avenue School – 1973-74	p. 16
Sixth Grade at the James A. Dever School – 1976	p. 17
Second Grade at the James A. Dever School – 1977	p. 18
Second Grade at the James A. Dever School – 1978	p. 19
Faculty of the Wheeler Avenue School dressed for their 50 th Anniversary – 1974	p. 20
Wetson's Hamburgers Sunrise Highway and Rockaway Boulevard - August 1972	p. 21
<i>The Eighties</i>	
Third Grade at the James A. Dever School – 1980	p. 13
James A. Dever Faculty – 1981	p. 14
Sixth grade at the James A. Dever School – 1982	p. 15
James A. Dever School Chorus - 1985-86	p. 16
James A. Dever School Orchestra – 1985-86	p. 17
Sixth Grade at the James A. Dever School – 1985-86	p. 18
James A. Dever School Spring Concert – 1986	p. 19
School District 13 All County Orchestra - 1987	p. 20
James A Dever School Orchestra – 1987	p. 21
School District 13 Band	p. 22
James A. Dever and Wheeler Avenue Schools Ensemble – 1988	p. 23
Mr. Edmund Chiarello, Band Director of the James A. Dever School - 1986 ³	p. 24
New York State School Boards Journal Cover – 1984	p. 25
Valley Stream Read In – 1984	p. 26
Valley Stream Read IN – 1984	p. 27
“Anatomy of a Neighborhood Protest” on Hospital Incinerator – 1987	p. 28
“1982 Survey Missed School Asbestos” – 1987	p. 29
“Asbestos Anxiety Soars on Island – 1987	p. 30
Building Inspection lunch – 1988	pp. 31, 32
<i>The Nineties</i>	
School District at UBS Plaza in Uniondale L.I. – 1993	p. 25
Music in our Schools – March 1994	p. 26
School District 13 Marching Band – 1994	p. 27
Tuba Player – 1995	p. 28
Drummer – 1996	p. 29
School District 13 Marching Band	p. 30
School District 13 Jazz Ensemble – 1996	p. 31

³ *Ibid.*, Volume XXVB September/October 1986 The Observer Vol. 20, No. 7 at 4

James A. Dever School Faculty – 1997	p. 32
James A. Dever School – 1997	p. 33
James A. Dever School Orchestra – 1999	p. 34
James A. Dever School Orchestra in Philadelphia – 1999	p. 35
James A. Dever School Orchestra in Philadelphia – 1999	p. 36
James A. Dever School’s musical group at Philadelphia – 1999	p. 37
Wheeler Avenue School’s Music in the Parks – 1999	pp. 38, 39
James A. Dever School Library under construction – 1999	p. 40
Howell Road School Library under construction – 1999	p. 41
Wheeler Avenue School Marching Band – 1999	p. 42
Wheeler Avenue Playground – 1998	p. 43
Wheeler Avenue School Faculty – 1998-99	p. 45
Mr. Suscia’s Music Class – 1998	p. 46
Wheeler Avenue School Faculty – 1999	pp. 47, 48
Wheeler Avenue School, Mrs. Waxman’s Class	p. 49
Wheeler Avenue School – 1999	p. 50
Wheeler Avenue School – January 1999	p. 51
Wheeler Avenue School	p. 52
Wheeler Avenue School - Bicycle Safety	p. 53
Wheeler Avenue School – 1999	p. 54
Wheeler Avenue School – 1998	p. 55
Wheeler Avenue School Faculty – 1999	p. 56
Village of Valley Stream Graph – 1990	pp. 57, 58
VSUFSD 13 Enrollment Figures	p. 59
District Thirteen Kindergarten Projections – 1983 to 1996	p. 60
District Thirteen Enrollment Figures – 1889 to 1999	p. 61
District Thirteen Demographic Information – 2003	p. 62
Valley Stream Planning Study – 1990 to 2000	p. 63
Valley Stream 13 UFSD Student Enrollment: Grades K – 6	p. 64
Valley Stream 13 UFSD Student Enrollment, Wheeler Avenue School	p. 65.
Valley Stream 13 UFSD Student Enrollment, James A. Dever School	p. 66
Valley Stream 13 UFSD Student Enrollment, Willow Road School	p. 67
Valley Stream 13 UFSD Student Enrollment, Howell Road School	p. 68
New York State VSUF School District 13 Report Card – February 2000	pp. 69 to 118
District Thirteen Enrollment Figures – 1893 to 2000	p.p. 119 to 125
District Thirteen Enrollment Graph by School – 1946 to 2001	pp. 127 to 130
Graphs of Resident Population of School District Thirteen – 1931 to 1999	pp. 131, 132
Wheeler Avenue School Library – ribbon cutting ceremony – March 2001	p. 133
Wheeler Avenue School computer room – November 2001	p. 136
Wheeler Avenue School – 2001	pp. 137 to 140
Memorial Day Parade – 2005	pp. 142 to 145
Valley Stream Union Free School District Thirteen Board Room - 2005	p. 146
James A. Dever PTA Installation Dinner	p. 147
Enrollment Figures	pp. 149 to 154
Resident Population of District Thirteen from 1931 to 1999	p. 155
Epilogue	pp. 156 to 162
<u>Chapter Three</u> (The District Boundary Lines)	
Historical Documents from the NYS Archives/Cultural Educational Center	p.p. 18 to 59
Willow Road Deed and Plot	p.p. 48 to 55
Howell Road Deed and Plot	p.p. 56 to 59
<u>Chapter Four</u> (Land Purchase and Building)	
School District 13 Schoolhouses– 1891, 1905 and 1924	pp. 21 and 95
Construction Photos of the four Schools in District 13 – 1950s	p.p. 22 to 93
Construction Photos of the four Schools in District 13 – 1950s	p.p. 96 to 106

Chapter Five (Transportation)

Chapter Six (Consolidation)

Consolidation study report - 1997 pp. 27 to 57
New York State School Boards Association Convention – 2000 p. 58

Chapter Seven (Valley Stream Teachers Association - VSTA)

Mr. Richard E. Herrmann, President VSTA – 2000 pp. 8 and 94
Valley Stream Teachers Association Newsletters p.p. 9 to 86
Teacher contract signing (Mr. Gimello, Mr. Carbonaro & Mr. Bucksbaum) – 1963 pp. 87, 88
Teacher contract signing (Mr. Gimello, Mr. Quick & Mr. Bell – 1963 pp. 89 to 90
Teacher Contract Signing (Mr. Gimello, Mr. Stille & Mrs. McAuliffe pp. 91 to 92
Teachers contract signing (Mr. Gimello, Mr. Dever & Mr. Holder) – 1965 p. 93

Chapter Eight (PTAS)

PTA

James A. Dever School Proclamation on 50 years of service to the community – 1999 p.10

Wheeler Avenue School PTA

Wheeler Avenue School Dedication Brochure – 1925 pp. 10 to 17
Photo of the first James A. Dever School PTA President - Mrs. Evens p. 11

Howell Road School PTA

Howell Road School Dedication Brochure pp. 8 and 8a
Howell Road School Charter – 1953 p. 9
Howell Road School PTA Executive Board – 1952-53 p. 10
Howell Road School First PTA Newsletter – 1952 pp. 11, 12
Bless This House – Benediction given at the dedication to the Howell Road School p. 13

Willow Road School PTA

Willow Road School PTA letters and First Newsletter – 1952-53 pp. 9 to 12
Willow Road School First PTA Newsletter – 1952-53 pp. 13, 14
Willow Road School Dedication Brochure pp. 17, 18

Interschool Committee of District 13 flier – 1975 p. 2

Chapter Nine (Joint Boards of Education)

Joint Boards minutes pp. 29 to 47
Fact sheet on Valley Stream Schools – 1965-66 pp. 48, 49
State Graph on District Negotiating Teams – 2000 p. 50
Joint Board Meeting – 1987 pp. 58, 59
NYSSBA Journal – The school board members as collective bargaining negotiator pp. 51 to 56
The Cost of Doing Business – 2002-2003 p. 57
Joint Board Meeting – January 15, 1987 p.p.58, 59
Chart on Nassau School Tax Rate Increases – 1999-2002 pp. 60, 61
Joint Boards Meeting – January 9, 2008 pp. 61, 66

Chapter Ten (Valley Stream State Park)

Ariel View of Valley Stream State Park – 1934 p. 9
Valley Stream State Park 1936 p. 10
Valley Stream State Park Bathing Beach p. 11
Skating at Hendrickson Park Lake – 1973 p. 12
Valley Stream Swimming Pool – 1964 p. 13
Swimming at Valley Stream Pool p. 14
Municipal Pool Replaces State Park Bathhouses p. 15

Newspaper Article on Village of Valley Stream acquiring NYC property Ariel view of Hendrickson Park and Central High School – 2002	p. 16 p. 17
<u>Chapter Eleven</u> (Civic Associations)	
Parkwold Map	p. 14
Parkwold Civic Flower Box - 1994	p. 15
Arbor Day – June 2, 1944	p. 16
Parkwold Banner – Phil and Louise LaPotra	p.17
Libby Perle and Cathy Guzzardo	p. 18
Christmas Caroling – 1991	p.p. 19, 20
Christmas Party	p. 21
Maria Turrisi – 1995	p. 22
Christmas Caroling – 1995	p.p. 23, 24
Pat Cairo Foundation Dinner Dance – 1996	p.p. 25, 26
Marcia Grant and Judge Anthony Marano – 1996	p. 27
Parkwold Civic Officers – 1996	p. 28
Block Party – 1998	p. 29
Holiday Party – 1998	p.p. 30 to 33
Parkwold House – 2001	p. 34
October In Parkwold	p. 35
Cathy Guzzardo	p. 36
Emilie Stris and Joanne Penna	p. 37
Parkwold Newsletter	p. 38
Gail Kostner Parent	p. 39
Norman Perle and Town of Hempstead Supervisor Thomas Gullota – 1983	p. 40
Parkwold Executive Board – 1982-83	p. 41
Lawn Party – 1983	p. 42
Banner	p. 43
Franklin General Hospital, Fosters Brook and Skobliski Lumber Yard	p. 44
Payan-Fletcher House - 1984	p. 45
Photos of Parkwold Houses	pp. 47 to 56
Parkwold Maps	pp. 57 to 62
The Parkwold Civic Association Corporate Seal – 1982	p. 63
Photo of the Parkwold Civic Association Executive Board – 1982	p. 64
Valley Stream Golf Course	p. 66
Morton Civic Corporate Seal – May 8, 1938	p. 67
Morton Estates Homes	p.p. 68 to 86
Morton Civic Association 75 th Anniversary Registry	p. 87
Norwood Park Civic Association Newsletters	pp. 89 to 110
Franklin Terrace Civic Association Newsletters	pp. 111 to 152
Italian American Civic Association	pp. 153 to 154
Friends of Bridge, Inc	p 155
Valley Stream Chamber of Commerce	p. 156
Nassau Educators Federal Credit Union	p. 157
<u>Chapter Twelve</u> (Summertime)	
Budget graph – 2001	p. 10
Salary graphs_– 2001	p. 11
<u>Appendix II</u> (Past District Thirteen Presidents)	
Photo – William F. Houston	p. 3
Photo – William B. Martin	p. 4
Photo – Andrew J. Hartman	p. 5
Photo – John Butler	p. 6
Photo – James F. Smollen, Jr.	p. 7
Photo – Howard M. Holder	p. 8

Photo – Leon J. Taub	p. 9
Photo – Harris Dinkoff	p. 10
Photo – Arline Strumeyer	p. 11
Photo – William P. Stris	p. 12
Photo – Frank J. Chiachiere	p. 13
<u>Appendix III</u> (District 13 “Hall of Fame”)	
Photo – William F. Houston	pp. 1, 2
Photo – James F. Smollen, Jr.	p. 3
Paul and Claire Fromer – 1984	p. 6
Paul Fromer at NYSSBA Convention – 1983	p. 7
Paul Fromer Retirement Party Brochure – 1990	pp. 9, to 12
Photo - Harris Dinkoff	p. 15
Campaign Literature	pp. 16 to 18
Photo – Arline Strumeyer	p. 20
Photo – Joseph F. Quinn	p. 22
Photo - William P. Stris	p. 25 to 48
<u>Appendix IV</u> (Administration)	
Harry W. Gross Newspaper Article	p.18, 20
Ira C. Mummert	p. 19
Ina M. Cole	pp. 21 to 23
Dr. Thomas J. Lee	p. 24
Martin Brooks and Harris Dinkoff	p. 25
Mary Ann Fithian and Margaret Daugherty	p. 26
Mary Ann Fithian	p. 27
Mary Ann Fithian and Robert Aloise	p. 28
<u>Appendix VI</u> (Public Attendance at Board Meetings)	
Graph of attendance at board meetings – 1958 to 2000	pp. 13, 14, and 15
<u>Appendix VIII</u> (District 13 Educational Foundation)	
Valley Stream Educational Foundation, Inc. Corporate Seal	p. 2b
Valley Stream Educational Foundation, Inc. Certificate	p. 3
Photo of Organizational Meeting – 1995	p. 9
World of Books Library Plaque – Superintendent Peg Daughterty and William Stris	p. 21
Foundation Fund Raiser	pp. 23, 24
<u>Appendix XI</u> (Tax Exempt Property)	
Franklin General Hospital	pp. 5 to 21
American Legion Post No. 44	pp. 22, 23
Veterans of Foreign Ward Post 1790	pp. 24, 25
Community Services for the Mentally Retarded	pp. 26, 27
Bridge, Drug Rehabilitation	pp. 28 to 31
Southern State Parkway Commission	pp. 32 to 38
Fireman’s Hall	pp. 39, 40
Nassau County Department of Public Works	pp. 41 to 44
Valley Stream State Park	pp. 45 to 59
<u>Appendix XII</u> (Organizations that Use District Thirteen Schools)	
Girl Scout Troop 2497	pp. 15 to 29
Brownie Troop 2504	pp. 30 to 33
Cub Pack Troop 74	pp. 34 to 36
Sea Rangers	pp. 37 to 52

Photos and Illustrations

Volume VIII

Dedication		
District Logo		
Instructional Service Staff (ISC)		i
Valley Stream Historical Society official Emblem		ii
<u>Chapter One</u> (Introduction)		
Photo of Brooklyn Avenue School – 1898		p. 20
Photos	Same as Volume I	pp 20 to 565
<u>Chapter Two</u> (Through the Decades)		
<i>Pre Twentieth Century</i>	Same as Volume I	
<i>The Teens</i>		
Brooklyn Avenue School - 1905		p. 12
Thomas West's Hotel showing contestants of bicycle marathon race on July 5, 1907		p. 13
School Desk and Chair ca, 1920		p. 14
Brooklyn Avenue School First Grade – 1910		p. 15
Brooklyn Avenue School Seventh Grade – 1912		pp. 16 & 17
Brooklyn Avenue School Baseball Team – 1911		pp. 18 & 19
Brooklyn Avenue School Third Grade – 1913		p. 20
Brooklyn Avenue School First Grade – 1915		p. 21
Brooklyn Avenue School First Grade – 1915		p. 22
Brooklyn Avenue School Eighth Grade – 1915		p. 23
Brooklyn Avenue School Eighth Grade – 1917		pp. 24 & 25
Brooklyn Avenue School Third Grade – 1917-18		p. 26
Brooklyn Avenue School Fourth Grade – 1918		p. 27
Brooklyn Avenue School Fifth Grade – 1919		p. 28
District 24 Enrollment Graph – 1913 – 2003		pp. 29, 30
<i>The Twenties</i>		
Neighborhood School Room - 1920		p. 15
Wheeler Avenue School – 1928		p. 16
Leap Year Minstrel brochure – 1927		pp. 17 & 18
Wheeler Avenue School Post Card		p. 19
Hoffman's Hotel		p. 20
Brooklyn Avenue School Seventh Grade – 1920-21		p. 21
Brooklyn Avenue School Eighth Grade – 1921		p. 22
Brooklyn Avenue School Sixth Grade – 1921-22		pp. 23 & 24
Brooklyn Avenue School Fourth Grade – 1922		pp. 25 & 26
Brooklyn Avenue School Third Grade – 1922-23		p. 27
Brooklyn Avenue School Eighth Grade – 1922-23		p. 28
Brooklyn Avenue School Kindergarten – 1923		pp. 29 & 30
Brooklyn Avenue School Eighth Grade – 1923-24		pp. 31 & 32
Brooklyn Avenue School First Grade – 1924		pp. 33 & 34
Brooklyn Avenue School First Grade – 1925		p. 35
Brooklyn Avenue School First Grade – 1925		pp. 36 & 37
Brooklyn Avenue School Second Grade – 1925		pp. 38 & 39
Brooklyn Avenue School Second Grade – 1926		pp. 40 & 41
Brooklyn Avenue School Fourth Grade – 1928		pp. 42 & 43
Brooklyn Avenue School Second Grade – 1926-27		pp. 44 & 45
Brooklyn Avenue School Third Grade – 1927-28		pp. 46 & 47
Brooklyn Avenue School Faculty – 1928		pp. 48 & 49

The Thirties

Brooklyn Avenue School Fifth Grade – 1930	p. 11
Brooklyn Avenue School Sixth Grade – 1930	pp. 12 & 13
Faculty, Principal, Secretaries, District 24 – 1938-39	pp. 14 & 15
Franklin Avenue School First Grade – 1939	pp. 16 & 17
Opening Night First Drive-In Theater V.S. – August 16, 1938	p. 18
Hotel Pitney on Rockaway Avenue – 1938	p. 19

The Forties

Franklin Avenue School Third Grade – 1940	pp. 15 & 16
District 24 Kindergarten – 1940	p. 17
District 24 First Grade – 1941	p. 18
Brooklyn Avenue – Kindergarten	p. 19
Brooklyn Avenue – First Grade	p. 19
Swing Band – 1947	p. 20

The Fifties

Brooklyn Avenue School Third Grade – 1956	p. 17
Brooklyn Avenue School 50 th Anniversary – 1957	p. 18
Long Island Press Newspaper article – “School Turns Back the Clock”	p. 19
Brooklyn Avenue School – 50 th Anniversary – 1958	p. 21
Brooklyn Avenue School Golden Jubilee Souvenir Program	pp. 23 to 26
Brooklyn Avenue School Sixth Grade – 1958	pp. 27 & 28
Brooklyn Avenue School Kindergarten – 1959	pp. 29, 30 & 31
Brooklyn Avenue School First Grade – 1959	pp. 32 & 33
Brooklyn Avenue School Second Grade – 1959	pp. 34 & 35
Brooklyn Avenue School Third Grade – 1959	pp. 36 & 37
Brooklyn Avenue School Fourth Grade – 1959	pp. 38, 39 & 40
Brooklyn Avenue School Fifth Grade – 1959	pp. 41, 42 & 43
Brooklyn Avenue School 50 th Anniversary – May 3, 1958	p. 44

The Sixties

Brooklyn Avenue School Kindergarten – 1968	pp. 16 & 17
Brooklyn Avenue School First Grade – 1968	pp. 18 & 19
Brooklyn Avenue School Second Grade – 1968	pp. 20 & 21
Brooklyn Avenue School Third Grade – 1968	pp. 22 & 23
Brooklyn Avenue School Fourth Grade – 1968	pp. 24, 25 & 26
Brooklyn Avenue School Fifth Grade – 1968	pp. 27 & 28

The Seventies

“Donahue School Is 50 Years Old” – December 18, 1975	p. 17
Brooklyn Avenue School Faculty – March 9, 1977	p. 19
Brooklyn Avenue School Kindergarten – March 9, 1977	pp. 20 & 21
Brooklyn Avenue School First Grade – March 9, 1977	p. 22
Brooklyn Avenue School Primary – March 9, 1977	pp. 23, 24 & 25
Brooklyn Avenue School Fourth Grade – March 9, 1977	pp. 26 & 27
Brooklyn Avenue School Sixth Grade – March 9, 1977	p. 28

The Eighties

Brooklyn Avenue School Faculty – 1981-82	p. 15
Brooklyn Avenue School Kindergarten – 1981-82	pp. 16 & 17
Brooklyn Avenue School Second Grade – 1981-82	pp. 18 & 19
Brooklyn Avenue School Third Grade – 1981-82	pp. 20 & 21
Brooklyn Avenue School Fourth Grade – 1981-82	pp. 22 to 23
Brooklyn Avenue School Fourth Grade – 1981-82	pp. 24 & 25

Brooklyn Avenue School Fifth Grade – 1981-82	pp. 26 & 27
Brooklyn Avenue School Sixth Grade – 1981-82	pp. 28 & 29
“Her Legacy: Love for Words” Newsday Newspaper – June 18, 1982	p. 31

The Nineties

William L. Buck Grade One – 1990-91	p. 11
William L. Buck Grade Two – 1990-91	pp. 12 & 13
William L. Buck Grade Three– 1990-91	p. 14
William L. Buck Sixth Grade – 1990-91	p. 15
William L. Buck Six Sixth Grade– 1990-91	p. 16
William L. Buck Sixth Grade – 1995-96	p. 17
Brooklyn Avenue School Staff – 1994-95	p. 19
Brooklyn Avenue School Faculty - December 1995	p. 20
Brooklyn Avenue School Kindergarten – 1994-95	pp. 21 & 22
Brooklyn Avenue School First Grade – 1994-95	pp. 23 & 24
Brooklyn Avenue School Second Grade – 1994-95	p. 25
Brooklyn Avenue School Forth Grade – 1994-95	p. 26
Brooklyn Avenue School Fifth Grade – 1994-95	p. 27
Brooklyn Avenue School Sixth Grade – 1994-95	pp. 28, 29, 30
Brooklyn Avenue School Third Grade – 1994-95	pp. 31 & 32
Brooklyn Avenue School Kindergarten – October 1995	pp. 33 & 34
Brooklyn Avenue School First Grade – 1994-95	pp. 35 & 36
Brooklyn Avenue School Second Grade – 1994-95	p. 37
Brooklyn Avenue School Third Grade – 1994-95	p. 38
Brooklyn Avenue School Forth Grade – 1994-95	p. 39
Brooklyn Avenue School Fifth Grade – 1994-95	p. 40
Brooklyn Avenue School Sixth Grade – 1994-95	p. 41
VSUFSD Twenty-Four Enrollment Graph – 1913 to 2003	pp. 43, 45
Brooklyn Avenue School Memorials	pp. 47 to 59
Memorial Day Parade – 2005	pp. 60, 61

Chapter Three (The District Boundary Lines)

Chapter Four (Land Purchase and Building)

District 24 Schoolhouse	p. 47
First Brooklyn Avenue School on Fifth Street, about 1898	p. 48
Brooklyn Avenue School on Post Card	pp. 49 & 50
Rear of the Brooklyn Avenue School – 2005	pp. 51 & 52
Franklin Avenue School – later names W.M. F. Donahue School	p. 53
Ground Breaking Ceremonies for the William L. Buck School – December 14, 1950	p. 54
Constructing New School in District 24 – April 27, 1950	pp. 55 & 56
Brooklyn Avenue School on Post Card	pp. 57, 58 & 59
Boy Rangers in front of Brooklyn Avenue School	pp. 60 & 61

Chapter Five (Transportation)

Chapter Six (Consolidation) Same as Volume I

Chapter Seven (VSTA) Same as Volume I

Chapter Eight (PTAS)

Dedication Program for the Franklin Avenue School – December 9, 1929	pp. 4 to 7
Donahue 50 th Anniversary Brochure	pp. 8 to 27
William L. Buck School Monopoly Game	p. 3
The Game Of Valley Stream	pp. 5 & 6
Dedication Program for the William L. Buck School – April 29, 1952	pp. 7, 8

Harbor Road School Dedication Brochure pp. 7, 8
 Valley Stream Union Free School District No. 24 PARENT HANDBOOK -1980-81 pp. 1 to 17

Chapter Nine (Joint Boards of Education) Same as Volume I

Appendix II (Past Presidents of School District 24)

Photo – William L. Buck p. 4
 Photo – William R. Collins p. 5
 Photo – Philip A. Archard p. 6
 Photo – Sidney Romash p. 7
 Photo – John S. McCuster p. 8
 Photo – Joseph Zabatta p. 9
 Photo – Anthony Iadevaio p. 10

Appendix III (School Board Hall of Fame)

William L. Buck – Photo p. 2
 William L. Buck Biography p. 3
 Henrietta Crabonaro – Photo p. 3
 Carbonaro Retirement Party Photo pp. 4 & 5
 Carbonaro Retirement Brochure pp. 7, 8
 Richard Glassberg – Photo p. 2
 Anthony Iadevaio – Photo p. 2
 Eleanor Scigliabaglio – Photo p. 2

Appendix IV (Administration)

Testimonial Dinner Brochure for Dudley C. Snyder – March 13, 1958 pp. 15

Appendix VIII (Gibson At A Glance)

William R. Gibson Photo -1880-1964 p. 2
 Gibson Civic Association Registry p. 35
 Bulletin Board on Sunrise Highway p. 37
 First Office of the Gibson Association p. 38

Appendix IX (Tax Exempt Properties)

American Legion pp. 5, 6
 Federation Employment and Federation of South Valley Stream pp. 7, 8
 Valley Stream Village Hall pp. 9 to 10
 Post Office pp. 11 to 12
 Senior Citizens Association pp. 13, 14
 Options for Community Living pp. 15, 16
 Services for the Mentally Retarded pp. 17, 18
 South Shore Association for Independent Living pp. 21, 22
 Valley Stream Waldinger Memorial Library p. 23
 Valley Stream Fire Department Engine Company No. 2 pp. 24, 25
 Valley Stream Fire Department pp. 26, 27

Appendix X (Historic Property Paper)

First one-room schoolhouse – 1894 p. 9
 Two-story frame school – 1898 p. 10
 Eight-room brick building – 1907 p. 11
 Brooklyn Avenue School – 1907, 1957 and 1990 p. 12
 Entire student body – 1905 p. 13
 Brooklyn Avenue School Post card – 1908 p. 14
 Construction of the Brooklyn Avenue School – 1907 p. 15

Valley Stream Map – 1873	p. 16
Valley Stream Map – 1880	p. 17
Valley stream Map 1914	p. 18
Valley Stream Map – 1960	p. 19

Photos and Illustrations

Volume XV

Dedication

<u>Chapter One</u> (Introduction)	Same as Volume I & VIII
-----------------------------------	-------------------------

Chapter Two (Through the Decades)

The Teens and Twenties

Clear Stream Avenue School Second Grade – 1923	p. 13
Clear Stream Avenue School Forth Grade - 1923	p. 14
Clear Stream Avenue School First Grade – 1924	p. 15
Clear Stream Avenue School Third Grade – 1926	p. 16
Clear Stream Avenue School Sixth Grade – 1925	p. 17
Clear Stream Avenue School Eighth Grade – 1927	p. 18
Primary Documentations	pp. 21 to 106

The Thirties

Clear Stream Avenue School Sixth Grade – 1930	p. 17
Clear Stream Avenue School Sixth Grade – June 1931	p. 18

The Forties

Mrs. Mary Parrish and Valley Stream Drive-In-Movie	p. 15
District Thirty Faculty - 1946-47	p. 16
Arbor Day – 1946	p. 17
Class of 1948 Photos	pp. 18 to 27
Clear Stream Avenue School Activities – 1949	p. 28
Class of 1949 Photos	pp. 29 to 37

The Fifties

Class of 1950	pp. 15 to 18
Clear Stream Avenue School Activities – 1950-51	p. 19
Clear Stream Avenue School Activities - 1951	p. 20 to 23
Clear Stream Avenue School Activities – 1951-52	pp. 24 to 26
Forest Road School Faculty – 1953-54	p. 27
Forest Road School Kindergarten – 1953-54	pp. 28 and 30
Forest Road School Photos (202 to 208, 210 to 211 & 213) – 1953-54	pp. 31 to 41
Forest Road School Faculty	p. 42
Forest Road School Basketball Team – 1953-54	p. 43
District Thirty PTA Charter Certificate – September 15, 1954	p. 44
Clear Stream Avenue School Chinese Unit	p. 45
School District Thirty Teacher’s Workshop – 1955	p. 46
Clear Stream Avenue School – 1956	p. 47
Clear Stream Avenue School Building – 1957	p. 48
District Thirty Board of Education – 1957	p. 49

The Sixties

Clear Stream Avenue School Faculty – January 5, 1961	p. 15
Clear Stream Avenue School Kindergarten – 1960	pp. 16 to 18

Clear Stream Avenue School First Grade – 1960	pp. 19, 20
Clear Stream Avenue School Second Grade – 1960	pp. 21 to 23
Clear Stream Avenue School Third Grade – 1960	pp. 24 to 26
Clear Stream Avenue School Fourth Grade – 1960	pp. 27 to 29
Clear Stream Avenue School Fifth Grade – 1960	pp. 30 to 32
Clear Stream Avenue School Sixth Grade – 1960	pp. 33 to 35

The Seventies

Clear Stream Avenue School Faculty – 1973-74	p. 15
Clear Stream Avenue School Kindergarten – 1973-74	pp. 16 to 18
Clear Stream Avenue School First Grade – 1973-74	pp. 19 to 21
Clear Stream Avenue School Second Grade – 1973-74	pp. 22, 23
Clear Stream Avenue School Third Grade – 1973-74	pp. 24 to 26
Clear Stream Avenue School –Fourth Grade – 1973-74	pp. 27, 28
Clear Stream Avenue School Fifth Grade – 1973-74	pp. 29, 30

The Eighties

Clear Stream Avenue School Faculty – 1981-82	p. 23
Clear Stream Avenue School Kindergarten – 1981-82	pp. 24, 25
Clear Stream Avenue School Grade One – 1981-82	pp. 26, 27
Clear Stream Avenue School Grade Two – 1981-82	pp. 28, 29
Clear Stream Avenue School Grade Three – 1981-82	pp. 30, 31
Clear Stream Avenue School Grade Four – 1981-82	pp. 32 to 33
Clear Stream Avenue School Grade Five – 1981-82	pp. 34, 35
Clear Stream Avenue School Grade Six – 1981-82	pp. 37, 38
Ralph Penza – PTA Awards Recipient	p. 39
Wooden Shoe Nursery	p. 40
District Thirty Lion	pp. 41 to 44

The Nineties

Shaw Avenue School First Grade – 1996-97	pp. 21 to 24
Shaw Avenue School Second Grade – 1997-98	pp. 24 to 28
Shaw Avenue School Third Grade – 1998-99	pp. 29 to 32
Shaw Avenue School Forth Grade – 1999-2000	pp. 33 to 37
Shaw Avenue School Fifth Grade – 2000-2001	pp. 38 to 42
Shaw Avenue School Faculty – 2000-2001	p. 43
Shaw Avenue School Sixth Grade – 1990	p. 44
Shaw Avenue School Sixth Grade – 1996-97	pp. 45, 46

Chapter Three (The District Boundary Lines)

Chapter Four (Land Purchase and Building)

First District Thirty School on Buscher Ave. and Montague Street	pp. 19, 20
Clear Stream Avenue School - September 10, 1955	pp. 21 to 23
Clear Stream Avenue School - April 10, 1955	p. 24
Forest Road School October 19, 1952	pp. 25 to 28
Forest Road School - December 13, 1953	pp. 30 to 34
Forest Road School – January 3, 1953	pp. 35 to 38
Forest Road School – March 7, 1953	pp. 39 to 41
Forest Road School - February 7, 1953	pp. 43 to 49
Forest Road School – April 4, 1953	pp. 51 to 54
Forest Road School – May 3, 1953	pp. 55 to 59
Forest Road School – June 6, 1953	pp. 61 to 64
Forest Road School – July 3, 1953	pp. 67 to 71
Forest Road School – August 6, 1955	pp. 72 to 75
Forest Road School – August 13, 1953	pp. 77 to 80

Forest Road School Building– 1953-54	p. 81
Clear Stream Avenue School – August 6, 1955	pp. 83 to 86
Forest Road School Addition – September 10, 1956	pp. 87 to 90

Chapter Five (Transportation)

<u>Chapter Six</u> (Consolidation)	Same as Volume I
------------------------------------	------------------

<u>Chapter Seven</u> (VSTA)	Same as Volume I
-----------------------------	------------------

Chapter Eight (PTA)

<u>Chapter Nine</u> (Joint Boards of Education)	Same as Volume I
---	------------------

Appendix II (District 30 Past Presidents)

Ronald E. Palmer	p. 6
Albert L. Anderson	p. 7
William Wenk	p. 8
Joseph M. Barry	p. 10
Thomas Galgano	p. 11
Richard Eisenberg	p. 12

Appendix III (District 30 Hall of Fame)

Photo – John Beresford	p. 2
Photo – Eleanor McAuliffe	p. 4

Appendix VIII (Tax Exempt Property)

Quality Services for the Autistic Community	p. 4
Green Acres Golden Community	pp. 5, 8
Options for Community Living	pp. 9, 10
Central Nassau Guidance and Counseling Inc.	pp. 11, 12
Clear Stream Avenue Firehouse	pp. 13, 14

Photos and Illustrations

Volume XXII

Introduction (The Structure of NYS School Board System)

Nassau County Museum Collection – Long Island Studies Collection

Culvert and Wash Gate in Conduct – 1874	p. 17
Carman’s Mill – 1874	p. 18
Pond above Carman’s Mill – 1874	p. 19
Bridge at head of Valley Stream Pond -1874	p. 20
Pines Pond Gatehouse – 1878	pp. 21 to 23
Pines Pond – 1879	p. 24
Pond above Carman’s Mill – 1879	p. 25
Mill on Watts Pond – 1880	p. 26
Pines Pond – 1880	p. 27
Smith’s Pond -1880	p. 28
Copy of Consolidated Districts in N.Y.S.	pp. 29 to 34
Nassau	pp. 29, 30
Erie	pp. 31, 34
Westchester	pp. 32, 33

Chapter One (Central High School – Past & Present)

Chapter Two (The Legal Foundations of a Central High School District)

Chapter Three (Through the Decades)

The Twenties and Thirties

Central High School Building (Rented from district 13)	p. 30
Mr. Gross	p. 32
First Board of Education Trustee's of the Central High School District	p. 34
Faculty – 1927	pp. 35, 36
Class President and Business Manager of the “Blue & Gold” yearbook	p. 37
Class treasurer and Secretary – 1927	p. 38
Editor of Static, Class newspaper	p. 39
Class Vice-President and Author of “Class Will” – 1927	p. 40
Class History – 1927	pp. 41 to 44
Central High School Class of 1925	p. 46
Centrals High School football Team – 1926	p. 47
Central High School Newspaper Staff – 1926	p. 48
Central High School Orchestra – 1926	p. 49
Central High School Cast of Play, Mr. Bob – 1926	p. 50
Central High School Athletic Association Executives – 1926	p. 51
Central High School Girls Basket Ball Team – 1926	p. 52
Central High School Boy's Basket Ball Team – 1926	p. 53
Central High School Football Team – 1926	p. 54
Central High School Band – 1928	p. 55
Central High School Class of 1928	pp. 56, 57
Central High School Class of 1929	pp. 58, 59
Central High School Football Team – 1929	p. 60
Central High School Girls basketball - 1935	p. 61
Central High School Class of 1930 at School District Thirteen Building – 1930	p. 63
Central High School Football League Champs – 1930	p. 64
Central High School Class of 1931	p. 65
Central High School Class of 1932	p. 66
Central High School Freshman Football Champs – 1933	p. 67
Central High School Class of 1936 – Girls Sports	p. 68
Central High School Class of 1937	p. 69
Central High School Girls Sports – 1938	p. 70
Central High School Songs	pp. 74 to 81
Central Class of 1931 visits Mount Vernon in Virginia – April 1931	pp. 72, 73
Central High School Tribute Dr. John Smith	p. 82
Photo copy of Petition – VSCHSD vs VSUFSD 13	pp. 84 to 120

The Forties and Fifties

Central High School Cheerleaders – 1941	pp. 26, 27
John M. Smith Band Shell at Village green Ca. 1960s	p. 29

The Sixties and Seventies

District Orchestra - 1965	pp. 29, 30
District Band	pp. 30, 31
District chores	p. 33
District Marching Band and Cheerleaders – October 16, 1974	p. 34
Memorial Junior High School Staff Members – July 1978	pp. 35 to 47
Third Annual Music Festival Program – April 9, 1960	pp. 48 to 55
Symphony Orchestra Program – December 1, 1966	pp. 56 to 60

Andrew Jackson high school desegregation Plan Decision	pp. 61 to 77
Memorial Jr. High School Musicals	pp. 78 to 95

The Eighties and Nineties

District Festival Chorus – 1993	pp. 29 to 31
District Music Festival – 1992	pp. 32 to 34
District Festival Band – 1994	pp. 35 to 37
District Festival Orchestra – 1995	pp. 38 to 40
District Festival Chorus – 1996	pp. 41 to 43
District Festival Chorus – 1997	pp. 44 to 46
Washington D.C. Trip	p. 47
Patriot Festival – 1999	p. 48
Washington D.C Trip – 1995	pp. 49
Washington D.C. Trip – 1998	pp. 50
Washington D.C. Trip – 1999	pp. 51
Howard Margolies and Renee Oxman Memorial	p. 52
Jerry Lasewicki Memorial	pp. 53, 54
Thirty-Fourth Annual Music Festival Program – March 16, 1991	pp. 55 to 59
District Music Festival, Chorus, Concert and Band – 2000	p. 60
Music Maestro Please, Philadelphia – 2001	p. 61
District Music Festival, Chorus, Concert and Band – 2003	p. 62
District Music Festival, Chorus, Concert and Band – 2004	p. 63
Valley Stream Central High School Staff – 2004	p. 64
Memorial Day Parade – 2005	pp. 65 to 69
Pedestrian Bridge at South High School over Hook Creek – Trustee Iadevaio	p. 70
Pedestrian Bridge at South High School over Hook Creek – Trustee Stris	p. 71
Valley Stream Central High School Building ca. 2002	p. 72
North High School Graduation – 2005	p. 73
Mark Bernstein, VSCHSD Superintendent presenting Budget to residents – 2005	p. 74

Chapter Four (Land Purchase and Buildings)

Map of VSCHSD with the elementary districts	p. 27
Surveyor Map of Philips Development Company	pp. 28 to 31
Cafeteria Map	pp. 32 & 34
Site Drawings	p. 35
VSCHS first building	p. 36
Central High School Land Option	pp. 37 to 41
Central High School – May 2, 1929	p. 42 to 45
Central High School Post Card – 1936	pp. 46 & 47
Custodian Joseph Cacabria	p. 48
Town of Hempstead School Bonds	pp. 49 to 52
North High School Architect Construction Photos	pp. 53 to 105
South High School Architect Construction Photos	pp. 106 to 153
Ariel view of North and South High Schools	p. 154
Ariel view of Central High School	pp. 155, 156
Central High School Auditorium Frieze	pp. 157 to 170
Valley Stream District Office/Board of Education Sign	p. 171
Outside view of Central High School	pp. 172 to 197
Principal's office at Central High School	p. 198
Hendrickson Park and Central High School	pp. 199 to 202
Inside View of Central High School Clock Tower	pp. 203 to 217
Valley Stream Central High School Clock Tower Repair	pp. 218 to 225
Central High School District No. 1 Dedication Exercise Program – December 17, 1929	pp. 226 to 238
Memorial High School Dedication Ceremony Program – November 11, 1953	pp. 239 to 242
Central High School Rededication Program – December 11, 1987	pp. 243 to 254

South High School 50th Anniversary Brochure	pp. 255 to 258
Valley Stream South, Past, Present, and Future – March 11, 2006	pp. 259 to 262
South 50 th Anniversary Souvenir Journal	pp. 263 to 270
Central High School front exterior (flower boxes and shrubbery)	pp. 271 to 289
District Auto Shop at Central High School	pp. 290 to 301
Valley Stream Central high school flower boxes August 14, 2008	pp. 302-303
<u>Chapter Five</u> (The PTSA and School Organizations)	
Valley Stream Central High School District PTA Council Photo	p. 29
<u>Chapter Six</u> (Enrollment)	
Enrollment Graph	pp. 9 to 12
District Demographics	pp. 13 to 23
<u>Chapter Seven</u> (VSTA)	Same as Volume I
<u>Chapter Eight</u> (Consolidation)	Same as Volume I
<u>Chapter Nine</u> (Joint Boards of Education)	Same as Volume I
<u>Appendices</u>	
Appendix V (Board of Education Members)	
Photos	pp. 33 to 47
Appendix VI (Past Presidents)	
Photos	pp. 3 to 40

Preface

Volume XVIIIa & XVIIIb Valley Stream Union Free School District Thirty Calendars of Events

This volume contains district-wide calendars for the following academic years: 1966-67, 1967-68, 1968-69, 1969-70, 1970-71, 1971-72, 1972-73, 1973-74, 1974-75, 1976-77, 1977-78, 1978-79, 1979-80, 1993-94, 1996-97, 1997-98, 1998-99, 1999-2000, 2000-01.

The original district-wide calendars were entitled "School Activities – Calendar." They measured 6½ by 9 inches. Each calendar was designed in a different color. At some point in the late 1980s the format changed to an 8 ¼ by 11 inches.

William P. Stris
December 31, 2000

UNION FREE SCHOOL DISTRICT THIRTY
VALLEY STREAM, NEW YORK

30

SCHOOL ACTIVITIES

Calendar

FOR 1965 - 1966

PUBLISHED BY THE BOARD OF EDUCATION AND PARENT TEACHER ASSOCIATION

TELEPHONE DIRECTORY

INDEX

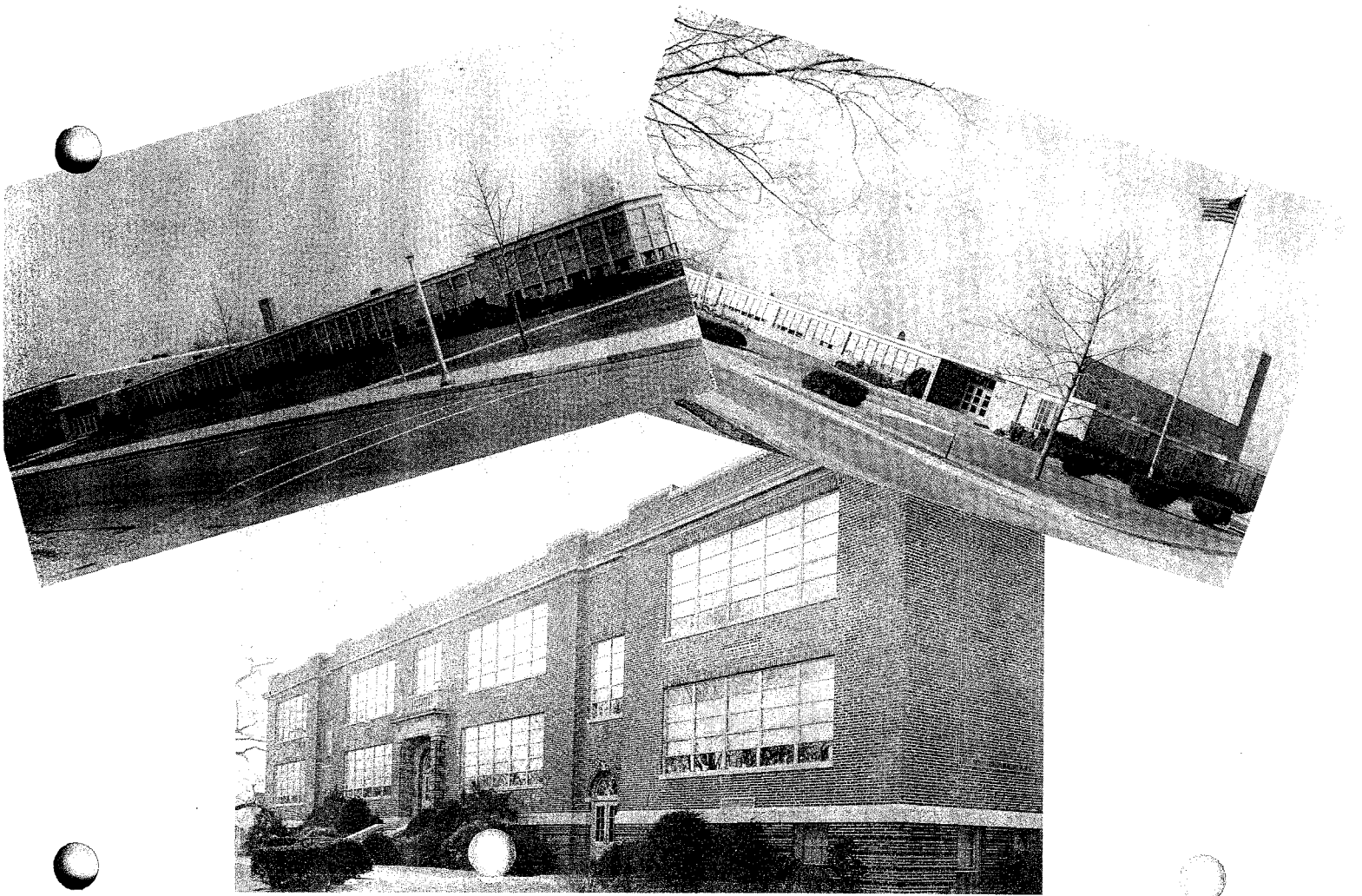

SEPTEMBER 1965

SUNDAY	MONDAY	TUESDAY	WEDNESDAY	THURSDAY	FRIDAY	SATURDAY
			1 P.T.A. Executive Board Meeting, Forest Road	2	3	4
behavior is caused. Everything a child does is caused by something or someone.						
5	6 LABOR DAY	7 Faculty Meeting	8 SCHOOL OPENS	9 P.T.A. Executive Board Meeting, Clear Stream and Shaw	10	11
12	13	14 C.H.S. Board Meeting, 8:00 p.m.	15	16	17	18
19	20	21 District No. 30 Board of Education Meeting, 8:15 p.m.	22 P.T.A. Regular Meeting Curriculum Teas-K-6-Forest	23 P.T.A. Regular Meeting Clear Stream Fund Raiser Shaw P.T.A.	24	25
26	27 ROSH HASHANAH	28 SCHOOL	29 P.T.A. Regular Meeting	30 Kindergarten and Pre-School Curriculum		Children learn to do by doing

BOARD OF EDUCATION

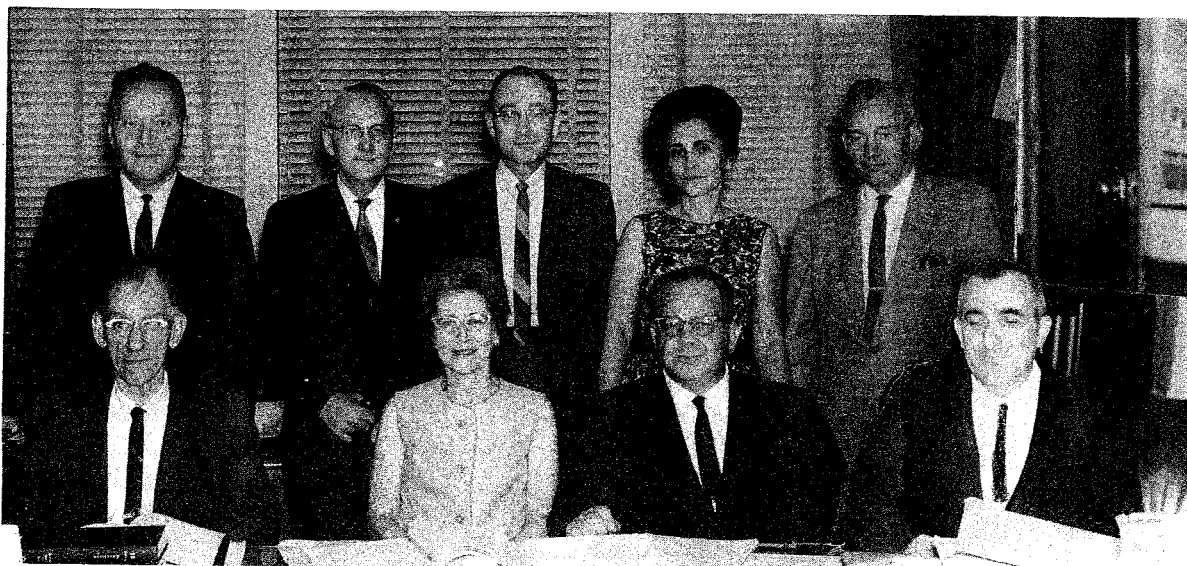

Standing (left to right): George Levine*, George Adams, Thomas Jewel, Eleanor Berger, Sherwood Quick. Seated: Robert Bell, President*; Elinor McAuliffe*; Nathaniel Altschul, Vice President; John Achini.

*Also serves on High School Board.

OCTOBER 1965

SUNDAY	MONDAY	TUESDAY	WEDNESDAY	THURSDAY	FRIDAY	SATURDAY
					1	2
	3	4 V.S. Council of P.T.A.-Meeting Brooklyn Ave. P.T.A. Executive Board Meeting, Shaw	5	6 YOM KIPPUR SCHOOL CLOSED	7 1st and 2nd Grade Teas, Clear Stream Kdg. and 1st Grade Teas, Shaw	8
10	11 FIRST DAY OF SUKKOTH FESTIVAL	12 COLUMBUS DAY SCHOOL CLOSED C.H.S. Board Meeting, 8:00 p.m.	13 P.T.A. Executive Board Meeting, Forest	14 5th and 6th Grade Teas, Clear Stream 2nd and 3rd Grade Teas, Shaw	15	16
17	18 CONCLUSION OF SUKKOTH FESTIVAL	19	20 South Nassau Zone Teachers Conference SCHOOL CLOSED Children's Movie-Forest	21 3rd and 4th Grade Teas, Clear Stream 4th Grade Tea, Shaw	22	23
24	25	26 District No. 30 Board of Education Meeting,	27 P.T.A. Regular Meeting, Forest	28 6th Grade Tea, Shaw	29 5th and 6th Grade Halloween Party	30

I have no right, by anything I say or do, to demean a human being in his own eyes. What matters is not what I think of him; it is what he thinks of himself. To undermine a man's self-esteem is a sin.

—Antoine de Saint-Exupéry

SHAW AVENUE PARENT TEACHER ASSOCIATION

EXECUTIVE BOARD 1965-1966

President	Mrs. L. Dimond	LO 1-7675
Vice-President	Mrs. M. Gersten	VA 5-9144
President	Mrs. B. Cohen	VA 5-0903
Treasurer	Mrs. I. Wexner	CO 2-0381
Recording Secretary	*Mrs. R. Teicheira	VA 5-9131
Public Relations Secretary	Mrs. J. Schiff	LO 1-9575
Delegates Council	Mrs. B. Danyluk	VA 5-5114
	Mrs. H. Wolf	CU 5-7350
	*Mrs. Colletti	VA 5-9131
Presidents	Mrs. S. Guttenplan	CU 5-7010
	Mrs. J. Schiff	LO 1-9575
Audio Visual	*Mr. J. Giacalone	VA 5-9131
Director	Mr. L. Dimond	LO 1-7675
	Mrs. J. Score	LO 1-0120
	*Miss Harris	VA 5-9131
Grade Representative	Mrs. B. Pine	CU 5-5806
Coordinator	Mrs. M. Horozan	CU 5-5706
Chairman	Mr. J. Schiff	LO 1-9575
Classification	Mr. & Mrs. M. Gersten	VA 5-9144
Membership	Mrs. Mantrone	VA 5-5128
Physical Health & Recreational Child	*Mrs. E. Levine	VA 5-9131
	Mrs. M. Balaban	CU 5-8191
Video & Stencil	Mrs. S. Guttenplan	CU 5-7010
Newsletter Editors	Mrs. I. Ierardi	CU 5-6047
Parent Education	Mrs. B. Cohen	VA 5-0903
	Mrs. S. Roth	VA 5-5607
School	Mrs. DiGiamo	LO 1-0079
	*Mrs. Borax	VA 5-9131
Program	Mrs. R. Infranco	LO 1-9799
Publications	Mrs. S. Schlaeger	CU 5-7588
Publicity	Mrs. L. Berkeley	VA 5-0246
School & Community Relations	Mrs. M. Fisher	LO 1-9675
Planning Committee	Mrs. W. Jansen	LO 1-0965
Kindergarten Rep.	Mrs. Diaz	CU 5-6126
1st Grade Rep.	Mrs. E. Wolff	CU 5-7552
2nd Grade Rep.	Mrs. M. Cecere	VA 5-9406
3rd Grade Rep.	Mrs. N. Amitrano	CO 2-5508
4th Grade Rep.	Mrs. M. Cutrone	VA 5-9419
5th Grade Rep.	Mrs. J. Evans	VA 5-8393
6th Grade Rep.	Mrs. S. Brownstein	CU 5-5985

P.T.A. PROGRAM

Sept. 23	Jelly Apple and Pretzel Sale
29	General Meeting: Introduction of Teachers by Mr. Busch. Entertainment by Mrs. Roemer; Guitar and Singing
Oct. 7	Kindergarten and 1st Grade teas
14	2nd and 3rd Grade Tea
21	4th Grade Tea
26	5th Grade Tea
28	6th Grade Tea
Nov. 11	Children's Movie
18	General Meeting: "Narcotics"
Dec. 15	General Meeting: Holiday Program presented by our students, directed by Miss Egan. P.T.A. Holiday Assemblies for the children.
Jan. 26	Paid-up Membership Meeting International Night
Feb. 10	Fashion Show
17	Joint P.T.A. Meeting at Clear Stream Avenue School. Founders Day.
Mar. 17	General Meeting: "Pre-Adolescence Problems" presented by Parent Education Committee.
May 6	Cake Sale
17	General Meeting. Buffet Supper; Installation of Officers; Entertainment by the "Talent Group" of Central High School under the direction of Mr. B. Keller.

EXECUTIVE BOARD MEETINGS

September 9 Thursday	February 2 Wednesday
October 4 Monday	March 3 Thursday
November 3 Wednesday	March 31 Thursday
December 1 Wednesday	May 4 Wednesday
January 5 Wednesday	June 8 Wednesday

NOVEMBER 1965

SUNDAY	MONDAY	TUESDAY	WEDNESDAY	THURSDAY	FRIDAY	SATURDAY
	1	2 ELECTION DAY SCHOOL CLOSED	3 REPORT CARDS SENT OUT TODAY P.T.A. Executive Board Meeting, Forest and Shaw	4 P.T.A. Executive Board Meeting, Clear Stream	5	6
7	8	9 C.H.S. Board Meeting, 8:00 p.m.	10 P.T.A. Regular Meeting Clear Stream Pre-School Workshop 3 p.m. — Forest	11 VETERANS DAY SCHOOL CLOSED P.T.A. Children's Movie, Shaw	12	13
14	15	16	17 P.T.A. Card Party, Forest Road	18 P.T.A. Fund Raiser, Clear Stream P.T.A. General Meeting, Shaw	19	20
21	22	23 District No. 30 Board of Education Meeting, 8:15 p.m.	24	25 THANKSGIVING RECESS	26 THANKSGIVING RECESS	27
28	29 SCHOOL REOPENS Parents' Night, Memorial, South, Central	30 Parents' Night, Memorial, South, Central	Where there is much desire to learn, there of necessity will be much arguing, much writing, many opinions; for opinion in good men is but knowledge in the making. —John Milton		The love of liberty is the love of others; the love of power is the love of ourselves. —William Hazlitt	

FOREST ROAD PARENT TEACHER ASSOCIATION

EXECUTIVE BOARD

ELECTED OFFICERS 1965-66

President
 Vice President
 and Vice President
 and Vice President
 Treasurer
 Social Secretary
 Corresponding Secretary
 Recording Secretary
 Delegate to Council
 Delegate to Council

Arline Glass PY 1-8088
 Marjorie Grauer PY 1-6043
 Eleanor Klein PY 1-3060
 Paul Genin PY 1-5867
 Lynn Kimelman PY 1-5356
 Dorothy Marks PY 1-9504
 Ceil Barnett PY 1-8114
 Pompei Macleod PY 1-7072
 Janet Sheffer PY 1-5318
 Gladys Parker Faculty

COMMITTEE CHAIRMEN

Admission
 Arts Mothers
 Arts Mothers
 Exceptional Child
 Family Living
 Finance
 Finance
 Food Will
 Health and Safety
 Librarian
 Music
 Nursery & Book Fair
 Parentship
 Physical Health
 Reading
 Social & Art
 Newsletter
 Librarian
 School
 Publications
 Publicity
 Publicist
 School Board Rep. Elem.
 School Board Rep. H.S.
 School & Comm. Relations
 Teacher Rep.
 Teachers and Parents
 Health & Recreation

Lynn Kinelman PY 1-5356
 Elaine Waldman PY 1-3140
 Eileen Silver PY 1-2060
 Ora Haines PY 1-6647
 Barbara Taylor PY 1-7730
 Celia Kushner PY 1-5709
 Irene Polakoff PY 1-4098
 Gloria Silverman PY 1-3257
 Irene Haupt PY 1-5471
 Betty Franey PY 1-9460
 Lawrence Schoen PY 1-6227
 Kaley Stern PY 1-5823
 Fanette Clapman PY 1-3009
 Wilma Baron PY 1-8159
 Gertrude Myron PY 1-2386
 Felice Pester PY 1-5414
 Claire Weinberg PY 1-3656
 Leah Berger PY 1-3768
 Jack Klein PY 1-3060
 Sally Newman PY 1-6743
 Iris Casson PY 1-4727
 Evelyn Kupferman VA 5-7407
 Dorothy Singer PY 1-9631
 Felice Pester PY 1-5414
 Ruth Perlman PY 1-5140
 Corky Shaw PY 1-8807
 Gladys Parker PY 1-7676
 Muriel Roth PY 1-4090
 Marcia Goldman PY 1-8929
 Harriet Bishop PY 1-5199

P.T.A. PROGRAM — 1965-66

- Sept. 1 Executive Board meeting—8:30 p.m.
- 2 General meeting—"Welcome to Forest Road." Curriculum discussion for kindergarten, grades 1 through 6—8:30 p.m.
- Oct. 13 Executive Board meeting—8:30 p.m.
- 20 Special childrens' program
- 27 General meeting—"Our Children Under Stress." Discussion led by Mrs. Kessler—8:30 p.m.
- Nov. 3 Executive Board meeting—8:30 p.m.
- 10 Pre-school workshop—"Let's Get Acquainted." Parents and children meet our kindergarten teacher, Mrs. Reinken—3:00 p.m.
- 17 PTA Card Party—8:30 p.m.
- Dec. 1 Pre-school workshop—"Fun With Art"—Part I. Half the children registered in program will meet with Art teacher. Parents will meet with Mrs. Salerno, school nurse, to discuss health and welfare of prospective kindergarteners. Miss Ritzenthaler—2:30 p.m.
- 3 & 4 PTA Book and Record Fair
- 15 PTA Holiday Program—gift to the children assembly
- Jan. 11 Pre-school workshop—"Fun With Art"—Part II. Second half of children meet with Art teacher, Miss Ritzenthaler. Program is repeated. 2:30 p.m.
- Feb. 2 Executive Board meeting—8:30 p.m.
- 8 Pre-school workshop—Program of rhythms and songs conducted by Miss Butler. Mrs. Reinken will talk with parents about kindergarten curriculum. 3:00 p.m.
- 17 District PTA meeting—Founders' Day Program—Clear Stream—8:15 p.m.
- Mar. 2 Executive Board meeting—8:30 p.m.
- 2 Pre-school workshop—Our Librarian, Mrs. Agree, conducts "Story-time" with children. Mrs. Moskowitz, our speech therapist, will discuss special program for kindergarten with the parents.
- 16 General meeting—"Physical Fitness"—grades 1 to 6—Mr. Stevens. 8:30 p.m. Election of officers.
- Apr. 13 Sex hygiene meeting—for parents of 6th graders—8:30 p.m.
- 20 Sex hygiene meeting—for mothers and daughters of 6th graders—8:00 p.m.
- 20 Pre-school workshop—Mrs. Reinken conducts "Free Play" in kindergarten room. Miss Barbone, Reading Specialist, will discuss ways for parents to help with reading readiness—3:00 p.m.
- 27 Sex hygiene—fathers and sons—6th grade—8:00 p.m.
- May 4 Executive Board meeting—8:30 p.m.
- 18 General meeting—"Narcotics"—Teacher's Recognition Day Dinner—Installation of Officers—8:30 p.m.
- June 8 Joint Executive Board meeting—8:30 p.m.

JANUARY 1966

SUNDAY	MONDAY	TUESDAY	WEDNESDAY	THURSDAY	FRIDAY	SATURDAY
						1 NEW YEAR'S DAY
2	3 SCHOOL REOPENS	4	5 P.T.A. Executive Board Meeting, Shaw	6 P.T.A. Executive Board Meeting, Clear Stream	7	8
9	10	11 C.H.S. Board Meeting, 8:00 p.m. Pre-School Workshop, Forest, 2:30	12	13 Pre-School Workshop, Clear Stream	14	15
16	17	18	19	20	21	22
23	24	25 District No. 30 Board of Education	26 P.T.A. Regular Meeting, Shaw	27	28 P.T.A. Regular Meeting, Clear Stream	29

SCHOOL ADMINISTRATION

Harry S. Gross, District Superintendent
 Sherwood S. Quick
District Principal

SCHOOL PRINCIPALS

CLEAR STREAM AVENUE SCHOOL
 Lawrence O. Lobdell

FOREST ROAD SCHOOL
 Maurice E. St. Mary

SHAW AVENUE SCHOOL
 John A. Busch

George W. Niederhauser, *Assistant Principal*

Curriculum Consultant
 William Van Ness

SCHOOL SECRETARIES

Mrs. Jeanne Feeney, Clear Stream Avenue
 Mrs. Mary McDowell, Forest Road
 Mrs. Jean Annona, Shaw Avenue

DISTRICT SECRETARIAL STAFF

Margaret Bradley Lucy Felice Helen Kuchler
 Annie O'Connell Marcella Pantaleo Mary Ribando
 Edythe Sanchez Caroline Y...

DISTRICT SPECIALISTS AND SPECIAL TEACHERS

Charles Bergwall, Guidance Consultant
 Frank DeMarco, Audio-Visual Consultant
 Rosalyn Kessler, Psychologist
 Edith Lauten, Psychologist
 Raydine Teicheira, Speech Consultant
 Rebecca Moskowitz, Speech Teacher
 Agnes Mabry, Reading Consultant
 Delores Stein, Foreign Language Consultant
 Lawrence Cid, Mathematics Consultant
 John Price, Instrumental Music Teacher
 Gilbert Jacobson, Instrumental Music Teacher

OTHER SPECIALISTS AND SPECIAL TEACHERS

Clear Stream Avenue School

Janet Poppe, Reading Specialist
 Grace Giacobone, Art
 Philip Hessemer, Physical Education
 Avonelle Stevenson, Music
 Ruth Newman, Librarian
 Edna Geibel, Nurse-teacher

Forest Road School

Ada Barbone, Reading Specialist
 Jean Ritzenthaler, Art
 Alfred Stevens, Physical Education
 Frances Butler, Music
 Rose Agree, Librarian
 Edna Salerno, Nurse-teacher

Shaw Avenue School

Jeanne Colton, Reading Teacher
 Louise Holbrook, Art
 Linda Maxwell, Art
 Noel Giambalvo, Physical Education
 Joan Kurman, Physical Education
 Katherine Egan, Music
 Susan Roemer, Music
 Etta Harmon, Librarian
 Dorothy McCutchan, Nurse-teacher

FEBRUARY 1966

SUNDAY	MONDAY	TUESDAY	WEDNESDAY	THURSDAY	FRIDAY	SATURDAY
Children are alike in many ways; they all go through the same stages of growth; yet each is different in many ways from all others.		1	2 P.T.A. Executive Board Meeting, Forest and Shaw	3 P.T.A. Executive Board Meeting, Clear Stream	4	5
6	7 V.S. Council of P.T.A. Meeting, Willow Road	8 C.H.S. Board Meeting, 8:00 p.m. Pre-School Workshop, Forest	9	10 P.T.A. Fund Raiser, Clear Stream P.T.A. Fashion Show, Shaw	11	12 LINCOLN'S BIRTHDAY
13	14	15	16 REPORT CARDS SENT OUT TODAY	17 District P.T.A. Meeting, "Founder's Day," Clear Stream	18	19
20	21 SCHOOL CLOSED	22 WASHINGTON'S BIRTHDAY SCHOOL CLOSED	23 ASH WEDNESDAY	24 District No. 30 Board of Education Meeting, 8:15 p.m.	25	26
27	28	Every now and then a man's mind is stretched by a new idea and never shrinks back to its original proportions. —Oliver Wendell Holmes Child rearing, with its variety and the demands it makes on the imagination, seems to me infinitely preferable to mind- ing an automated machine or even to programming computers. Most men are being forced at present into a rigid world				

WHAT IS CURRICULUM?

a curriculum a set of textbooks to be mastered?
 a mass of facts to be memorized?
 a series of more or less unrelated subjects to be pursued?

OR . . .

is it the child's total learning experience . . .
 is it the child's experience of life on his level . . .
 is it inside the classroom and out?
 Modern educational thought and practice have adopted the last
 of these definitions: the curriculum is the total learning experience
 of the child.

THESE IDEAS AS APPLIED TO DISTRICT THIRTY

Right in the beginning—in kindergarten, that is—the curriculum includes essential experiences in the art of working and living together. Here are learned the rudiments of cooperative living, so vital to the development of children as social beings. In addition, many of the experiences promote the child's readiness for the reading and number activities he will have in the first grade.

Are we learning about plants in the first grade? Or food and nutrition in the third? Or the earth's surface in the sixth?

Then, if we grow a few little plants in our classroom we will actually learn that plants need sunlight and air and water to live and grow. Or if we visit a supermarket, we will be able to learn at first hand many of the tasks involved in supplying a large population with food. Or if we gather different kinds of plants, and identify them and label them, and if we construct papier mache models of certain topographical features, and if perhaps we put all these things together into a kind of exhibit display, we will gain an understanding of our earth's surface that we could never get from reading alone.

WE DO READ, OF COURSE!

There never was a time when elementary schools made such rich use of books as they do today. There never were finer books—texts, reference and reading books—than we have and use today.

But—how can children learn the fundamentals when they are growing plants, visiting places outside school, and constructing displays?

Well—when, in first grade, we raise a few little plants, we do much more than learn about growing things. Our plants actually help us to learn to read . . . and learn to write.

When we visit a supermarket, or go on any kind of trip, we learn much more than the facts immediately connected with our visit. We have to figure how much the trip will cost, how much time it will take, and so on. When we get back, we discuss our experiences and write about them. We may write the supermarket manager a letter of thanks.

When we make a display, we learn a lot about vocabulary and spelling; we learn to print neatly, so we can label our display items; we write compositions about the items we display.

There are many other ways in which the curriculum is a *part of life*, rather than *apart from life*. We can't visit other lands, or restore ancient civilizations . . . but we can bring these things to us, and we do, by means of books, motion pictures, filmstrips, slides, television, recordings and pictures.

So, you see, we do teach "fundamentals." They're here, very definitely. We teach them through meaningful experiences. All of the basic subjects—reading, writing, mathematics, spelling, science, history and geography (usually called social studies) are part of the curriculum. And, of course, we also teach art, music, physical education, and French.

And so . . . this is the curriculum. It contains all the fundamentals, all the basic skills. In addition, it is related to life—life as the child knows it, as he can see it and hear it and touch it.

MARCH 1966

SUNDAY	MONDAY	TUESDAY	WEDNESDAY	THURSDAY	FRIDAY	SATURDAY
Child develops according to his pattern and passes thru the stages at his own rate of development.		1	2 P.T.A. Executive Board Meeting, Forest, 8:30 Pre-School Workshop, Forest, 2 p.m.	3 P.T.A. Executive Board Meeting, Clear Stream, 1:15 p.m. P.T.A. Executive Board Meeting, Shaw	4	5
6	7	8 C.H.S. Board Meeting, 8:00 p.m.	9	10	11 P.T.A. Father and Son Night, Clear Stream	12
13	14	15	16 P.T.A. Regular Meeting, Forest, 8:30	17 ST. PATRICK'S DAY P.T.A. Regular Meeting, Clear Stream and Shaw	18	19
20	21	22 District No. 30 Board of Education Meeting, 8:15 p.m.	23	24	25 District No. 30 Instrumental Program, Shaw	26
27	28	29	30 REPORT CARDS SENT OUT TODAY	31 Board Candidates Night, Forest P.T.A. Executive Board Meeting, Shaw	Most, if not all, human problems can be solved by human beings working together cooperatively rather than in conflict with one another. —Walter Starks	

SCHOOL POLICIES

GYM SUITS AND SNEAKERS

Gym suits are required of pupils below the 4th grade, but sneakers are necessary for any pupils using the gym. Boys and girls from the 4th through 6th grades are required to wear gym suits and sneakers on the assigned gym days. The gym teachers will explain this to the pupils, but many times they do not bring correct information home.

Boys who **MUST PURCHASE A NEW SUIT** should buy the one-piece ROYAL BLUE, bloomer type, with elastic bottoms, or ROYAL BLUE shorts with elastic insert in the cuff, and a white shirt. Boys should wear ROYAL BLUE shorts, with elastic top, and sneakers (high top ones preferred), and white or SCHOOL "T" socks.

IF A CHILD HAS ANOTHER COLOR, OR TYPE, HE DOES NOT HAVE TO BUY A NEW ONE. The above apparel may be purchased at many local stores in Valley Stream. **NO ONE IS ALLOWED ON THE GYM FLOOR WITHOUT SNEAKERS.**

APPOINTMENTS WITH TEACHERS

In order that pupils' classtime be used to the fullest advantage, we request that parents do not seek conferences with teachers during school hours. If you wish a conference, please make an appointment to see the teacher after school. Teachers are available for such conferences every day except Mondays and Fridays.

BICYCLES

Bicycles are allowed at either Forest Road or Clear Stream Avenue Schools because no child lives far enough from the school to make them necessary. They are allowed at Shaw, but are restricted to pupils in grades 4, 5, and 6 who live NORTH OF CLEAR STREAM AVENUE. Bicycles used to come to the Shaw Avenue School will be assigned a number. All must have a lock and a bell for safety purposes.

GIFTS TO TEACHERS PROHIBITED

The policy of the school district which became effective January 1956, is to prohibit the acceptance of gifts by faculty members on school premises, and to prohibit the solicitation of funds for personal gifts purposes, by any person, or person on the premises.

IN-DAY PROGRAM

In inclement weather, there is an in-day program of motion pictures provided for those pupils who eat in the cafeteria. Pupils who go home to lunch are not allowed to participate in this program because of space limitations, so we ask parents to return these pupils to school on such days just in time for the afternoon session—not before 12:50 p.m. for grades 1 to 3, and 12:20 p.m. for grades 4 to 6 at Shaw and Forest; and not before 12:55 for grades 1 to 3 and 12:15 for grades 4 to 6 at Clear Stream.

HOMEWORK REQUIREMENTS

Homework is required of all pupils, but it will vary from day to day. First and second grade pupils may have fifteen to twenty minutes of homework per day, while third and fourth grade pupils are likely to have thirty to forty minutes. Fifth and sixth graders are expected to devote as much as an hour to homework, but again this may not be every day—it will depend on the pupil and his needs.

LOST AND FOUND

Unmarked articles lost by pupils are placed in the Lost-and-Found, which is in the Nurse's Office. Such articles, if not claimed at the end of the school year, are given to a charitable organization. However, any articles bearing a child's name is returned directly to him. Please place your child's name on all his belongings.

STAYING AFTER SCHOOL

To eliminate any confusion or problems, the school may have your child every day for an additional half hour. During this half hour beyond the regular school day, the teacher may schedule your child for special help or keep him for any of several reasons. We ask that you keep this in mind and not schedule dental appointments, dancing lessons, etc. until after that interval. Teachers are also available to parents during the half hour after school, except on Monday and Friday, for conferences. Appointments are not necessary, but it is to your advantage to make one, so that you can be sure of the teacher's availability.

ASSEMBLIES

When your child's class puts on the assembly, we welcome your attendance, but we do ask you not to bring pre-school children. As much as we realize that it is a thrill for them to see big brother perform, they are often distracting to those concerned.

MAY 1966

SUNDAY	MONDAY	TUESDAY	WEDNESDAY	THURSDAY	FRIDAY	SATURDAY
1	2	3	4 VOTING ON SCHOOL BUDGET P.T.A. Executive Board Meeting, Forest, 8:30 also Shaw Ave.	5 P.T.A. Executive Board Meeting, Clear Stream	6 P.T.A. Cake Sale, Shaw	7
8	9	10 C.H.S. Board Meeting, 8:00 p.m.	11	12 P.T.A. Pre-School Tour, 3:45 p.m. Clear Stream	13	14
15	16	17 TEACHER RECOGNITION DAY Forest Road Art Exhibit P.T.A. Reg. Mtg., Shaw	18 REPORT CARDS SENT OUT TODAY P.T.A. General Meeting, Forest	19 Clear Stream Ave. Art Exhibit	20	21
22	23	24 District No. 30 Board of Education Meeting, 8:15 p.m.	25 JEWISH PENTECOST	26 Shaw Avenue Art Exhibit P.T.A. General Meeting, Clear Stream	27	28
29	30 MEMORIAL DAY	31	Each child brings into the world with him his own basic characteristics in speed of maturing, limits of intelligence, body structure, energy drive			

WHO MAKES CURRICULUM CHANGES?

On the page over the month of March we discussed what curriculum is. On this page we want to delve more into this area; specifically, how curriculums are made and who makes them. Many changes have been made in recent years in what is taught elementary school pupils. Geography and history as separate subjects were combined into social studies some twenty years ago; science, though taught for many years in District Thirty, was only recently added to most elementary schools; mathematics has been given added emphasis in the past several years; and much for elementary pupils is an addition made in the past few years.

WHAT CAUSED THESE CHANGES?

There are a great many factors and reasons. The great explosion in scientific knowledge was a major factor. This has caused schools to not only emphasize science but has been one reason for the introduction of the new mathematics to the elementary school. The great improvement in means of communication—e.g. Telstar—has been a contributing factor to the shrinking of the world so that we are much closer to neighbors we thought of as remote and foreign to us. Knowledge of our neighbor's languages cannot help but increase the effectiveness of our communication and mutual understanding.

Improved transportation, as well as communication, has also aided in making this "One World" we now live in. Being so close in a matter of travel-time, it is more imperative than ever that we get to know the people of these other cultures, and it is most important, that we get to understand the reasons for their behavior thus, changes now taking place in the social studies, stress understanding of people.

Now, where did the impetus for such changes originate? Actually in a great number of places and people. First, many of the better ideas were gleaned by staff members at the educational conferences they have attended. In addition, visits to schools doing educational experimentation have often spurred local

changes. The State Education Department has suggested many changes but we have discovered that the schools of Long Island are usually ahead of the State Department in making changes. College and University professors have delved more and more in recent years into the elementary school curriculum and they have become stimulators to public school people in the area of curriculum change. Educational foundations have also spurred much of the changes with monies funneled into educational investigations. In recent months both the State and Federal government have made available funds to schools for further educational exploration.

All these agencies have contributed, and will continue to contribute, to the changes made in school curriculum offerings.

In District Thirty, the administrators and teachers are fully aware of what is going on in the area of curriculum change. We will continue to observe, study, and evaluate new proposed changes in the light of district needs and values to be gained by new approaches for the children of the district.

CURRICULUM AREAS RECENTLY, OR PRESENTLY UNDERGOING EXAMINATION AND/OR REVISION IN DISTRICT THIRTY

- | | |
|-------------------|-------------------|
| SCIENCE | ENGLISH |
| MATHEMATICS | FOREIGN LANGUAGES |
| SOCIAL STUDIES | READING |
| HEALTH AND SAFETY | |
-

JUNE 1966

SUNDAY	MONDAY	TUESDAY	WEDNESDAY	THURSDAY	FRIDAY	SATURDAY
			1	2	3	4
No matter what a child does, he is learning. Growth and learning are continuous. When you're through learning, you're through.						
5	6 V.S. Council of P.T.A. Meeting, North High	7	8 P.T.A. Joint Board Meeting, Forest, 8:30	9 P.T.A. Joint Board Meeting, Clear Stream	10	11
12	13	14 C.H.S. Board Meeting, 8:00 p.m.	15	16	17	18
19	20	21	22	23 GRADUATION	24 LAST DAY OF SCHOOL	25
26	27	28 District No. 30 Board of Education	29	30	You cannot make a child learn anything, but you can help him to be able to learn and to want to learn.	

**UNION FREE SCHOOL DISTRICT No. 30 AND
CENTRAL HIGH SCHOOL DISTRICT No. 1,
VALLEY STREAM, NEW YORK**

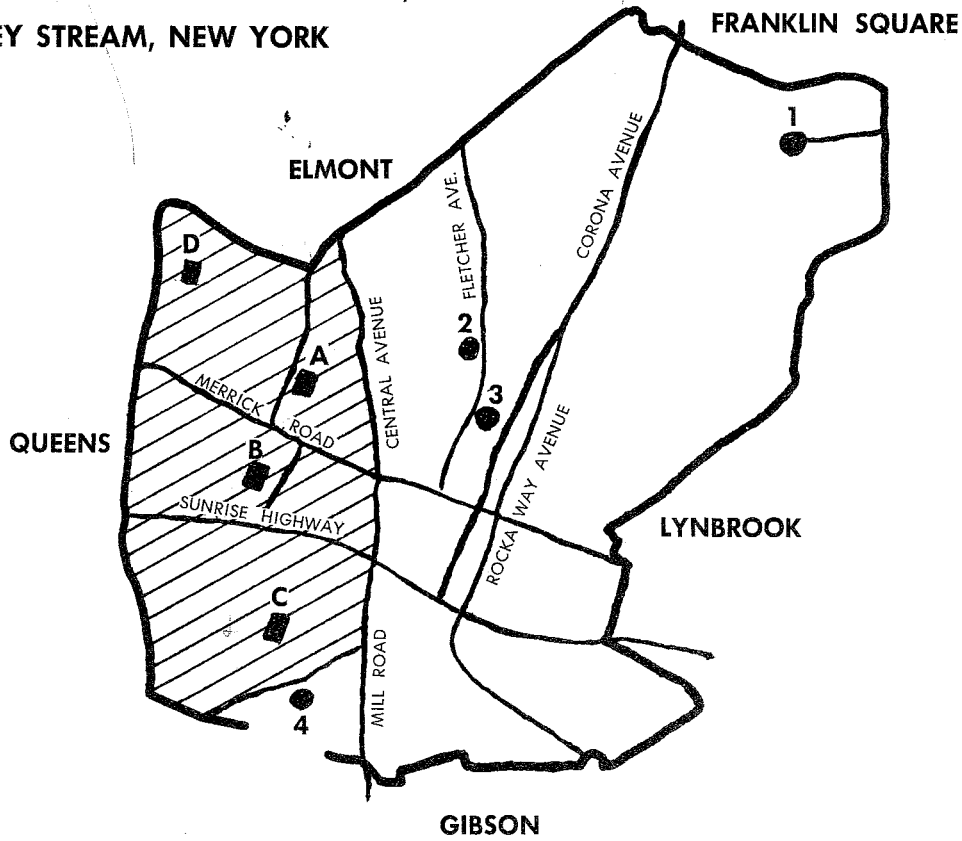

DISTRICT No. 30 SCHOOLS

- Shaw Avenue A
- Clear Stream Avenue B
- Forest Road C
- Washington Avenue D

Shaded Area — District 30

HIGH SCHOOLS

- North High 1
- Memorial Junior 2
- Central High 3
- South High 4

ONE MILE

JULY 1966

NDAY	MONDAY	TUESDAY	WEDNESDAY	THURSDAY	FRIDAY	SATURDAY
					1	2
3	4	5 School Board Reorganization Meeting	6	7	8	9
10	11	12 C.H.S. Board Meeting, 8:00 p.m.	13	14	15	16
17	18	19	20	21	22	23
24	25	26 District No. 30 Board of Education Meeting, 8-15 p.m.	27	28	29	30

"Nothing that was worthy in the past departs; no truth or goodness realized by man ever dies, or can die."
—Thos. Carlyle, Sir Walter Scott

CLEAR STREAM AVENUE SCHOOL

CLASS MOTHER LIST

Room	Class	Mother	Tel. Number	Teacher
30)	9	Julia Martin	CU 5-9204	Miss Willigan
30)	9	Betty Daly	CU 5-9579	Miss Willigan
:00)	9	Margaret Carlson	CU 5-8857	Mrs. Behrenfeld
:00)	9	Miriam Cohen	CO 2-9330	Mrs. Behrenfeld
30)	9	Mary Tragner	CU 5-9502	Mrs. Behrenfeld
30)	9	Ann Prisco	CU 5-5744	Mrs. Behrenfeld
B	Irene Marta	LO 1-6956	Mrs. Schaaf	
B	Millie Stott	CO 2-4862	Mrs. Schaaf	
7	Irene Kielawa	LO 1-1075	Mrs. Williams	
7	Kay Schmidt	872-8692	Mrs. Williams	
8	Bea Harris	LO 1-1256	Mrs. Koubek	
8	Doris Horowitz	CO 2-2865	Mrs. Koubek	
2	Dolores Plant	LO 1-2154	Mrs. Guberman	
2	Evelyn Pearlman	CU 5-5723	Mrs. Guberman	
5	Hilda Flynn	VA 5-6081	Mrs. Galati	
5	Helen Martino	CU 5-5834	Mrs. Galati	
6	Connie Deering	CU 5-6210	Mrs. Ugenti	
6	Sarah Berman	CU 5-6291	Mrs. Ugenti	
1	Marilyn Kavitt	CO 2-9122	Mrs. Kleinman	
1	Patricia Hogan	VA 5-7085	Mrs. Kleinman	
3	Cathy Eggolt	CU 5-7873	Mrs. Mendelson	
3	Marilyn Lombardo	LO 1-2931	Mrs. Mendelson	
4	Doris Moser	VA 5-1596	Miss LeJeune	
4	Rose Marie Ruvolo	LO 1-1699	Miss LeJeune	
23	Helen D'Aquanno	LO 1-1183	Miss Galbraith	
23	Elsie Fare	VA 5-8123	Miss Galbraith	
25	Muriel Schult	CU 5-8631	Miss Yelland	
25	Irene Pederson	LO 1-9823	Miss Yelland	
27	Ann Snider	CU 5-7302	Mrs. Robbins	
27	Maxine Luck	LO 1-6596	Mrs. Robbins	
26	Frances Malinsky	LO 1-0250	Miss Woods	
26	Mary Visconti	CU 5-7947	Miss Woods	
28	Muriel Watterson	CO 2-5478	Mrs. Wicht	
28	Doris Hamilton	CU 5-9417	Mrs. Wicht	
21	Grace Landon	CO 2-3491	Mr. McNiven	
21	Arlene Cooper	CO 2-6987	Mr. McNiven	
22	Pat DeMayo	VA 5-5290	Miss Bergler	
22	Joan Thompson	VA 5-1724	Miss Bergler	
24	Marlene Matland	CU 5-7054	Miss Pincus	
24	Edna Calkin	CU 5-8579	Miss Pincus	

FOREST ROAD SCHOOL

CLASS MOTHER LIST

Grade	Room	Class Mother	Tel. Number	Teacher
K	AM	Sylvia Gleicher	PY 1-8174	Mrs. Reinken
K	AM	Marlene Schoen	PY 1-6227	Mrs. Reinken
K	PM	Debbie Zarchy	PY 1-7039	Mrs. Reinken
*K	PM	Iris Casson	PY 1-4727	Mrs. Reinken
1	202	Pearl Lustbader	PY 1-9547	Mrs. Katz
1	202	Lynn Kimelman	PY 1-5356	Mrs. Katz
1	203	Nina Weitzner	PY 1-9615	Miss Cafiso
1	203	Edith Siegel	PY 1-8247	Miss Cafiso
*1	204	Diane Kahn	PY 1-4756	Mrs. Deitrich
1	204	Corky Shaw	PY 1-8807	Mrs. Deitrich
2	205	Francine Eisenstadt	PY 1-4840	Miss Perrich
2	205	Sara Fox	PY 1-7553	Miss Perrich
*2	206	Emma Bremen	PY 1-5070	Miss Post
2	206	Estelle Cohen	PY 1-7637	Miss Post
*3	207	Helen Fragner	PY 1-5828	Mrs. Cummings
3	207	Beverly Brosterman	PY 1-7021	Mrs. Cummings
3	209	Barbara Taylor	PY 1-7730	Miss Landi
3	209	Beverly Goldie	PY 1-7444	Miss Landi
4	208	Marge Grauer	PY 1-6043	Miss Bendin
4	208	June Blum	PY 1-7521	Miss Bendin
4	210	Ann Portney	PY 1-6490	Miss Duck
4	210	Jackie Katzel	PY 1-7050	Miss Duck
4	211	May Schechter	PY 1-7504	Miss Nancken
*4	211	Dorothy Marks	PY 1-9504	Miss Nancken
5	212	Irene Haupt	PY 1-5471	Mrs. Parker
5	212	Helen Ganz	PY 1-8262	Mrs. Parker
5	214	Celia Kushner	PY 1-5709	Mr. Kaufmann
5	214	Belle Charney	PY 1-7471	Mr. Kaufmann
5	215	Marilyn Thorner	PY 1-5274	Mrs. Melnick
5	216	Muriel Roth	PY 1-4090	Mrs. Melnick
5	216	Elaine Seltzer	PY 1-7337	Miss Ackerman
5	216	Gladys Singer	PY 1-8037	Miss Ackerman
6	217	Carolyn Green	PY 1-7946	Mrs. Kalsmith
6	217	Elaine Lieberthal	PY 1-5098	Mrs. Kalsmith
*6	218	Elsa Siegel	PY 1-8036	Mrs. Burkle
6	218	Eleanor Haber	PY 1-6678	Mrs. Burkle
6	219	Jean Fox	PY 1-5923	Mr. Riccobono
6	219	Ruth Robinson	PY 1-4058	Mr. Riccobono
6	220	Anita Laken	PY 1-8805	Mrs. Stalb
6	220	Eileen Silver	PY 1-2060	Mrs. Stalb

*Grade Coordinator

AUGUST 1966

SUNDAY	MONDAY	TUESDAY	WEDNESDAY	THURSDAY	FRIDAY	SATURDAY
	1	2	3	4	5	6
7	8	9 C.H.S. Board Meeting, 8:00 p.m.	10	11	12	13
14	15	16	17	18	19	20
21	22	23 District No. 30 Board of Education Meeting, 8:15 p.m.	24	25	26	27
28	29	30	31	"Intellect is invisible to the man who has none." —Schopenhauer. Essays		

SHAW AVENUE SCHOOL

CLASS MOTHER LIST

Grade Representative Co-Ordinator Mrs. B. Pine, CU 5-5806

Room	Class Mother	Tel. Number	Teacher	Gr.	Room	Class Mother	Tel. Number	Teacher	
Kindergarten	Representative	Mrs. J. Diaz, CU 5-6126				Fourth Grade Representative	Mrs. M. Cutrone, CU 5-9419		
301 AM	Mrs. W. Gunderson	CU 5-5693	Mrs. Hartman	4	104	Mrs. M. Salg	LO 1-2082	Miss Wallace	
301 PM	Mrs. M. Coppola	CU 5-8032	Mrs. Hartman	4	109	Mrs. S. Guttenplan	CU 5-7010	Miss Krumholz	
101 AM	Mrs. W. Poche	VA 5-2742	Mrs. Borax	4	110	Mrs. A. Schultz	LO 1-0852	Mrs. Hamcke	
101 PM	Mrs. J. Robson	CO 2-0598	Mrs. Borax	4	111	Mrs. L. Genona	CO 2-7894	Mrs. Barnaby	
102 PM	Mrs. J. DiGiovanna	CU 5-5116	Miss Willigan	4	112	Mrs. R. Roth	CU 5-8143	Miss Boemio	
First Grade	Representative	Mrs. E. Wolff, CU 5-7552				Fifth Grade Representative	Mrs. J. Evans, CU 5-8393		
302	Mrs. S. Guttenplan	CU 5-7010	Mrs. Kraft	5	114	Mrs. D. Deer	285-7974	Miss Harris	
303	Mrs. E. Wolff	CU 5-7552	Mrs. Lazar	5	116	Mrs. E. Spina	VA 5-2369	Miss Schwartz	
103	Mrs. E. Arce	VA 5-3230	Mrs. Levine	5	117	Mrs. A. Spinelli	CU 5-9428	Mrs. Aronin	
105	Mrs. I. Ierardi	CU 5-6047	Miss Davis	5	118	Mrs. L. Hennig	VA 5-6212	Miss Richardson	
106	Mrs. E. Tilts	VA 5-5848	Miss Dikeman	5	119	Mrs. F. Caggiano	CU 5-6004	Mrs. Sherman	
Second Grade	Representative	Mrs. M. Cecere, VA 5-9406				122	Mrs. F. Szatmary	CU 5-8554	Miss Murray
126	Mrs. M. Salg	LO 1-2082	Miss Santoro			Sixth Grade Representative	Mrs. S. Brownstein, CU 5-5985		
128	Mrs. S. Goldfisher	CU 5-6227	Miss Stein	6	121	Mrs. A. Gagliano	CU 5-5898	Mr. Sortino	
130	Mrs. G. Whetstone	LO 1-8101	Mrs. Paradiso	6	123	Mrs. A. Cronberg	VA 5-1367	Miss Lanell	
133	Mrs. A. Baum	VA 5-6571	Mrs. Colletti	6	124	Mrs. A. Horovan	CU 5-5706	Miss Brown	
Third Grade	Representative	Mrs. N. Amitrano, CO 2-5508				125	Mrs. J. Ierardi	CU 5-6047	Mrs. Rosche
107	Mrs. M. Milone	VA 5-7165	Mrs. Strumpf	6	127	Mrs. M. Fisher	LO 1-9675	Mr. Giacalone	
108	Mrs. R. Morris	CU 5-5225	Miss Mack	Special					
132	Mrs. J. Digiaimo	LO 1-0079	Mrs. Stevens	Cl. 131		Mrs. J. Kinnaird	LO 1-7427	Miss Croley	
135	Mrs. E. Drucker	CU 5-9677	Mrs. Benedetto						

SCHOOL TELEPHONE DIRECTORY

SHAW AVENUE SCHOOL	
Principal	VA 5-9131
Class Office	VA 5-9131
Administrative Manager	VA 5-9131
Washington Avenue School	
Principal's Office	VA 5-3044
Class Office	VA 5-3044
Forest Road School	
Principal's Office	PY 1-7676
Class Office	PY 1-7676

Shaw Avenue School	
Principal's Office	VA 5-9131
Nurse's Office	VA 5-9131
Washington Avenue School	
Office	VA 5-9131
Special Services	
Elementary Consultant	VA 5-9131
Guidance Consultant	VA 5-9131
Psychologist	VA 5-9131
Speech Consultant	VA 5-9131
Reading Consultant	VA 5-9131
Mathematics Consultant	VA 5-9131
Audio-Visual Consultant	LO 1-1165

INDEX

Board of Education	see October
Shaw Avenue PTA	see November
Clear Stream PTA	see December
Forest Road PTA	see January
Administration and Special Services	see February
Curriculum	see March and June
School Policies	see April and May
Map of District	see July
Clear Stream and Forest Class Mothers	see August
Shaw Class Mothers	see facing page

CENTRAL HIGH SCHOOL DISTRICT NO. 1
 Telephone Number: VA 5-8642
 Use this number for all high school buildings, offices and personnel

NOTES

FOR 1965-1966

Calendar

SCHOOL ACTIVITIES

UNION FREE SCHOOL DISTRICT THIRTY
VALLEY STREAM, NEW YORK

30

UNION FREE SCHOOL DISTRICT THIRTY
VALLEY STREAM, NEW YORK

30

SCHOOL ACTIVITIES

Calendar

FOR 1966-1967

PUBLISHED BY THE BOARD OF EDUCATION AND PARENT TEACHER ASSOCIATION

TELEPHONE DIRECTORY

INDEX

FOR 1966-1967

Calendar

SCHOOL ACTIVITIES

UNION FREE SCHOOL DISTRICT THIRTY
VALLEY STREAM, NEW YORK

30

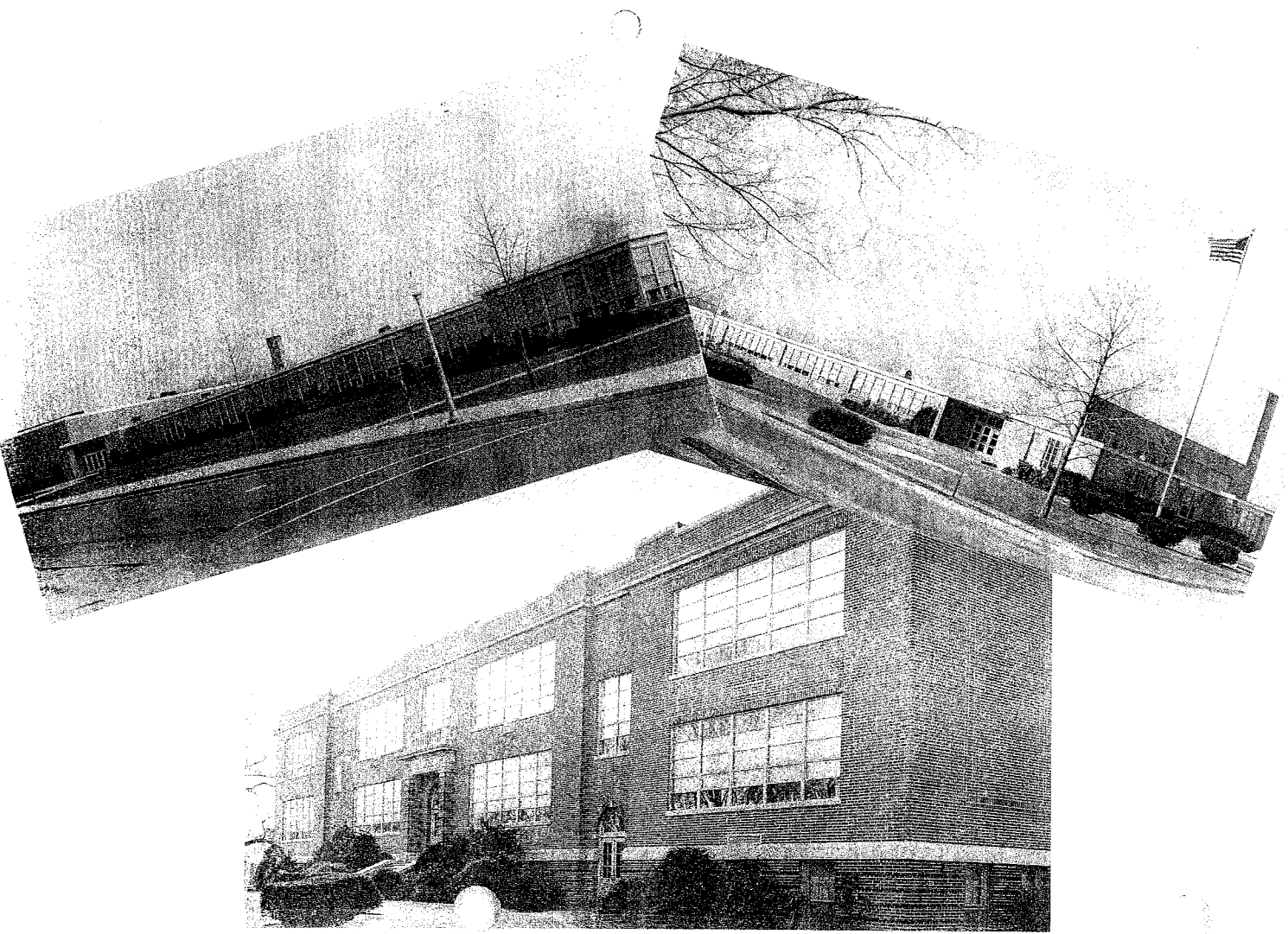

S E P T E M B E R 1 9 6 6

SUNDAY	MONDAY	TUESDAY	WEDNESDAY	THURSDAY	FRIDAY	SATURDAY
				1	2	3
4	5	6	7	8	9	10
	LABOR DAY	Faculty Meeting	SCHOOL OPENS Book Covers sold, Clear Stream, 2:45 p.m. PTA School Supplies Sale, Forest	PTA Ex. Bd. Mts., Shaw Avenue and Clear Stream, 8:15 p.m. PTA School Supplies Sale, Cl. St. & For.		
11	12	13	14	15	16	17
		C.H.S. Board Meeting, 8 p.m.		ROSH HASHANAH SCHOOL CLOSED	ROSH HASHANAH SCHOOL CLOSED	
18	19	20	21	22	23	
		Dist. No. 30 Board of Education Meeting, 8:15 p.m.	PTA Reg. Mt., Shaw Page Burgee PTA Reg. Mt., Forest "Getting To Know You," 8:30 p.m.	PTA Reg. Meeting, Clear Stream, 8 p.m.		
25	26	27	28	29	30	

Education I mean that training in excellence from youth upward which makes a man
nately desire to be a perfect citizen, and teaches him to rule, and to obey, with justice.
the only sort of education which deserves the name. That other sort of training which
t acquiring wealth or bodily strength is not worthy to be called education at all."—Plato

BOARD OF EDUCATION



Standing (left to right): George Levine*; George Adams, School Attorney; Eleanor Zeller, Board Clerk; Eleanor Berger, Board Treasurer; Sherwood Quick, District Principal. Seated: Robert Bell, President*; Elinor McAuliffe*; Nathaniel Altschul, Vice President; John Achini.

*Also serves on High School Board.

SCHOOL CALENDAR, 1966-1967

City Meetings (School District Conference)	Tues., Sept. 6	Christmas Recess	School Closes at
Registration	Tues., Sept. 6	Lincoln's Birthday	Regular Time
First Day of School	Wed., Sept. 7	Washington's Birthday	School Reopens
Rosh Hashanah	Thurs. & Fri., Sept. 15 & 16	Easter Recess	School Closes at
Autumn Bus Day	Wed., Oct. 12	School Reopens	Regular Time
Board Conference (NYS Teachers' Assn.)	Fri., Oct. 21	School Reopens	School Reopens
Registration Day	Tues., Nov. 8	School Closed	Wed., March 22
Parents' Day	Fri., Nov. 11	Memorial Day	Mon., April 3
Thanksgiving Recess	School Closes 12 Noon	School Closes for Pupils	Mon., May 29
	School Reopens		Tues., May 30
	Mon., Nov. 28		Fri., June 23

OCTOBER 1966

SUNDAY	MONDAY	TUESDAY	WEDNESDAY	THURSDAY	FRIDAY	SATURDAY
						1
						8
						15
						22
						29

Children wear a sign which reads, 'I want to be important NOW,' and many of our juvenile delinquency problems arise because nobody reads the sign."
—Dan Pursuit, Youth Studies Center, University of South Carolina

"Don't laugh at youth for his affectations; he is only trying on one face after another to find his own."
—Logan Pearsall Smith

V.S. Council of PTA Meeting, Harbor Road

PTA Ex. Bd. Mt., Shaw

PTA Ex. Bd. Mt., Clear Stream, 1:15 p.m.
PTA Ex. Bd. Mt., Forest, 8:30 p.m.

C.H.S. Bd. Mt., 8 p.m.
Kdg. & 1st Grade Teas, Shaw

COLUMBUS DAY SCHOOL CLOSED
PTA Children's movie & Jelly Apple Sale, 1 p.m. Clear Stream

2nd Grade Tea, Shaw
Kdg. & Pre-school Tea, Clear Stream, 8 p.m.

Joint Board Meeting, Wm. L. Buck School, 8:15 p.m.
3rd & 4th Grade Teas, Shaw

PTA Gen. Mt., "Values —Suburbia Style," Forest, 8:30 p.m.

5th Grade Tea, Shaw
1st & 2nd Grade Teas, Clear Stream, 8 p.m.

TEACHERS' CONF. SCHOOL CLOSED
PTA Children's movie, Cl. St. & For. 1 p.m.

Dist. No. 30 Board of Education

3rd & 4th Grade Teas,

Children's Conc., Shaw
PTA Cake Sale, Forest, 11 a.m.-4 p.m.

SHAW AND WASHINGTON AVENUES PARENT TEACHER ASSOCIATION

ELECTED OFFICERS 1966-1967

<i>Presidents</i>	Milton & Leah Gersten	VA 5-9144
<i>First Vice President</i>	Sylvia Guttenplan	CU 5-7010
<i>Second Vice President</i>	Harriet Wolf	CU 5-7350
<i>Treasurer</i>	Arlene Wexner	CO 2-0381
<i>Recording Secretary</i>	Stella Schlaeger	CU 5-7538
<i>Financial Secretary</i>	Lenore Schiff	LO 1-9575
<i>Corresponding Secretary</i>	Norma Cohen	VA 5-0903
<i>Delegates to V.S.</i>	Ann Danyluk	VA 5-5114
<i>Council</i>	Mrs. R. Paradiso	Faculty
<i>Past President</i>	Ginnie Dimond	LO 1-7675

COMMITTEE CHAIRMEN

<i>Audio Visual</i>	Mr. J. Giacalone	Faculty
<i>Budget</i>	Les & Ginnie Dimond	LO 1-7675
<i>Cheer</i>	Marie Cutrone	CU 5-9419
<i>Cultural Arts and Children's Theater</i>	Miss M. Mack	Faculty
	Helen Inwald	CU 5-5964
	Arlene Wexner	CO 2-0381
	Mrs. R. Strumpf	Faculty
	Mrs. E. Levine	Faculty
<i>Distribution</i>	Evelyn Pearn	VA 5-2261
<i>Grade Representative</i>	Joanne Evans	CU 5-8393
<i>Coordinators</i>	Evelyn Pearn	VA 5-2261
<i>Health and Safety</i>	Angela De Stefano	CU 5-7806
<i>Historian</i>	Emily Manno	CU 5-5852
<i>Hospitality</i>	Mary Catalfomo	VA 5-2225
	Frances Feldman	CU 5-6190
	Marie Spinelli	CU 5-9428
<i>Legislation</i>	John Schiff	VA 5-5828
	Madeline Silver	LO 1-6376
<i>Membership</i>	Ann Danyluk	VA 5-5114
	Jacqueline Pena	CO 2-0887
<i>Mental Health and Exceptional Child</i>	Kay Hadjiyane	CU 5-7434
	Betsy Pine	CU 5-5806
<i>Mimeograph Newsletter</i>	Mrs. C. Aronin	Faculty
	Miriam Balaban	CU 5-8191
	Mary Horozan	CU 5-5706
<i>Parent Education</i>	Ida Ierardi	CU 5-6047
	Harriet Wolf	CU 5-7350
<i>Parliamentarian</i>	Mrs. D. Colletti	Faculty
<i>Pre-School</i>	Ginnie Dimond	LO 1-7675
	Mary Baier	872-8751
<i>Program</i>	Mrs. J. Hartman	Faculty
	Sylvia Guttenplan	CU 5-7010
	Rita Kleiner	CU 5-6045
<i>Publications</i>	Madeline Silver	LO 1-6376
<i>Publicity</i>	Rita Infranco	LO 1-9799
<i>School Board Representative</i>	Angela Carmosino	872-8259
	Frances Feldman	CU 5-6190
<i>Ways and Means</i>	Marie Cecere	VA 5-9406
<i>Goodies Sale</i>	Betty Madrian	VA 5-7844

Movie

Cake Sale

Fashion Show

Welcoming

Youth and Recreation

Kindergarten Rep.

- 1st Grade Rep.
- 2nd Grade Rep.
- 3rd Grade Rep.
- 4th Grade Rep.
- 5th Grade Rep.
- 6th Grade Rep.

Miriam Balaban	CU 5-8191
Madeline Silver	LO 1-6376
Marie Di Giamo	LO 1-0079
Gloria Pellegrino	VA 5-8150
Angela Carmosino	872-8259
Ann Danyluk	VA 5-5114
Lee Schiff	LO 1-9575
Angela Carmosino	872-8259
Shirley Roth	VA 5-5607
Les Dimond	LO 1-7675
Sol Johnson	CU 5-7499
Marie Di Giamo	LO 1-0079
Jo Diaz	CU 5-6126
Edith Wolf	CU 5-7552
Marie Cecere	VA 5-9406
Norma Amitrano	CO 2-5508
Donnie Gally	VA 5-6206
Joyce Fisher	LO 1-9675
Harriet Wolf	CU 5-7350

P.T.A. PROGRAM

- Sept. 21 Jelly Apple and Pretzel Sale
- 21 General Meeting: Meet the Faculty. Travelogue—
- Noted lecturer, Page Burgie
- Oct. 11 Kindergarten and 1st Grade Teas
- 13 2nd Grade Tea
- 18 3rd and 4th Grade Teas
- 20 5th Grade Tea
- 25 6th Grade Tea
- Nov. 11 Children's Movie
- 16 PTA Holiday Assemblies for children: Mrs. Dorothy Waldo Phillips—Children's author and entertainer.
- 16 General Meeting: Mrs. Phillips
- 29 Cake Sale
- Feb. 16 Founder's Day Celebration: Guest Panel. Topic: "Our Changing Moral Values."
- March 7 General Afternoon Meeting: Election of Officers. "Family Living Workshop."
- 9 Fashion Show
- April 12 Paid-up Membership Party
- 19 "Mental Health Workshop"; afternoon
- May 16 "Teachers' Recognition Day"; Luncheon.
- 17 General Meeting. Installation of Officers. Entertainment: Mrs. Susan Roemer

OPEN EXECUTIVE BOARD MEETINGS

September 8 Thursday	February 1 Wednesday
October 4 Tuesday	March 2 Thursday
November 2 Wednesday	April 5 Wednesday
November 30 Wednesday	May 3 Wednesday
January 4 Wednesday	June 7 Wednesday

NOVEMBER 1966

SUNDAY	MONDAY	TUESDAY	WEDNESDAY	THURSDAY	FRIDAY	SATURDAY
in life is to be feared. It is only to be understood." —Marie Curie	1	2	PTA Ex. Bd. Mt., Shaw REPORT CARDS SENT OUT TODAY PTA Ex. Bd. Mt., Forest	3	4	5 Children's Theater Central H.S. "Tom Sawyer"
not read a book before, it is to all ends and purposes, new to me, whether it was read yesterday, or three hundred years ago." —William Hazlitt	6	7	8	9	10	11
		ELECTION DAY SCHOOL CLOSED C.H.S. Board Mt., 8 p.m.	9	Pre-school Mt., Forest Mrs. Reinken, "Let's Get Acquainted," 3 p.m.	10	11
			16	Father & Faculty Night Clear Stream, 8 p.m.	17	18
			Holiday Assem. and reg. PTA Meeting, Shaw Avenue PTA Gen. Mt., "Your Children's Values," Forest, 8:30 p.m.	17	18	19
			22	PTA Card Party, Clear Stream, 8 p.m.	25	26
			23	24	25	26
		Dist. No. 30 Board of Ed. Meeting, 8:15 p.m.	23	24	25	26
			THANKSGIVING RECESS SCHOOL CLOSURES AT 12:00 NOON	24	25	26
			30	THANKSGIVING RECESS	25	26
			PTA Ex. Bd. Mt., Shaw Avenue Parents' Night,	24	25	26
		PTA Cake Sale,	30	24	25	26
				"The old-fashioned parent is one who believes that stern discipline means exactly what it says." —From North Carolina Education		
				"By enlightenment men gain insight into their own being, and that		

CLEAR STREAM AVENUE PARENT TEACHER ASSOCIATION

ELECTED OFFICERS 1966-1967

<i>President</i>	Melba Williams	LO 1-9774
<i>First Vice-President</i>	Rose Weltsek	LO 1-1038
<i>Second Vice-President</i>	Kay Ciccone	LO 1-9207
<i>Treasurer</i>	Muriel Schult	CU 5-8631
<i>Membership Secretary</i>	Muriel Watterson	CO 2-5478
<i>Corresponding Secretary</i>	Josephine Heckman	LO 1-6414
<i>Reading Secretary</i>	Miss Edith Yelland	Faculty
<i>Delegates to V.S. Council</i>	Miss Barbara Pincus	Faculty
	Carol Sadowski	CO 2-6972
<i>Past President</i>	Lee Cohen	CU 5-5668

COMMITTEE CHAIRMEN

<i>Arts & Flyers</i>	Carol Sadowski	CO 2-6972
	Gladys Stankiewicz	LO 1-8498
<i>Audio-Visual</i>	Mr. Frank DeMarco	Faculty
<i>Budget</i>	Ruth Kane	LO 1-0865
<i>Civic Relations</i>	Ruth Novak	CO 2-4363
	Jane Klasmeyer	CU 5-5811
<i>Cultural Arts</i>	Anne Planco	LO 1-2218
	Ann Snider	CU 5-7302
<i>Decorations</i>	Miss Louise LeJeune	Faculty
<i>Health & Mental Health</i>	Ann Planco	LO 1-2218
<i>Historian</i>	Gert Ganzl	CO 2-2004
<i>Legislation</i>	Mary Zeno, Chrm.	285-5298
	Frances Zizzo, Co-Chrm.	CO 2-8681
<i>Librarian</i>	Bea Oakley	CU 5-6721
<i>Mimeographers</i>	Rita DeStefano	VA 5-2169
	Eleanor Lacerra	CU 5-8211
<i>Parent Education</i>	Lee Cohen	CU 5-5668
<i>Parliamentarian</i>	Dorothea Munson	LO 1-2547
<i>Pre-School</i>	Lois Barry, Chrm.	CU 5-8654
	Joan Buzzetta	CU 5-5473
	Arlene Cooper	825-7779
	Dorothea Munson	LO 1-2547
<i>Program</i>	Kay Ciccone	LO 1-9207
<i>Publications</i>	Hilda Flynn	VA 5-6081
<i>Publicity</i>	Jean Saladino	LO 1-7827
<i>Public Relations</i>	Ruth Cornish	872-8491
<i>Safety</i>	Muriel Grancher, Chrm.	CU 5-7637
	Madelyn Weiss	CO 2-1719
<i>Scholarship</i>	Martha Deknatel	CU 5-7310
<i>School Board Delegates</i>	Warren Cornish	872-8491
	Jim Williams	LO 1-9774
<i>School and</i>	Jo Heckman, Chrm.	LO 1-6414
<i>Community Relations</i>	Kay Schmidt	872-8692
<i>Line</i>	Elena Cirenza	CU 5-5671

THE STREAMER

	Helen Martino, Ed.	CU 5-5834
	Marion Bourne, Asst. Ed.	561-8237
	Mrs. Edna Giebel	Faculty
	Doris Horowitz, Dist.	CO 2-2865
<i>Typist</i>	Connie Deering	CU 5-6210
<i>Ways & Means</i>	Rose Weltsek, Chrm.	LO 1-1038
	Doris Hamilton, Co-Chr.	CU 5-9417
	Cathy Eggolt	CU 5-7873
	Dorothy Wirth	VA 5-6261
	Margie Croak	VA 5-9352
<i>Hospitality</i>	Elaine Kirchmann, Chr.	LO 1-7353
	Marilyn Kavitt, Co-Chr.	CO 2-9122
	Lillian Serpico	LO 1-0117
	Irene Pederson	VA 5-0374
<i>Kindergarten Rep.</i>	Jeanette Ermler	VA 5-6368
<i>1st Grade Rep.</i>	Peggy Carlson	CU 5-8857
<i>2nd Grade Rep.</i>	Pat Strobl	CO 2-4640
<i>3rd Grade Rep.</i>	Evelyn Pearlman	CU 5-5723
<i>4th Grade Rep.</i>	Rita DeStefano	VA 5-2169
<i>5th Grade Rep.</i>	Mary Lou Mullen	285-5253
<i>6th Grade Rep.</i>	Stella Speciale	VA 5-4779

P.T.A. PROGRAM

Sept. 7, 8	Sell Book Covers, 2:45 p.m.
22	Regular P.T.A. Meeting. Nassau County District Attorney William Cahn will speak on Narcotics. 8 p.m.
Oct. 12	Movie and Jelly Apple Sale for the children, 1:00 p.m.
13	Kindergarten and Pre-School Tea, 8:00 p.m.
20	1st and 2nd Grade Tea, 8:00 p.m.
21	Kiddie Movie, 1:00 p.m.
27	3rd and 4th Grade Tea, 8:00 p.m.
Nov. 3	5th and 6th Grade Tea, 8:00 p.m.
10	Father and Faculty Night, 8:00 p.m.
17	FUND RAISER Card Party, 8:00 p.m.
Jan. 19	Regular P.T.A. Meeting. A Common School and Community Problem will be resolved by the audience's participation in Role Playing. Mrs. Schoenfeld will moderate, 3:15 p.m.
Feb. 9	FUND RAISER "Chinese Auction," 8:00 p.m.
16	Founder's Day at Shaw Ave.
23	Pre-School Tour, 3:00 p.m.
March 16	Regular P.T.A. Meeting, 3:15 P.M. Meet our "Special Teachers."
April 19	Cake Sale, 2:45 p.m.
May 11	Pre-School Workshop, 8:00 p.m.
25	Regular P.T.A. Meeting. Installation, 8:00 p.m. Magic with Science

D E C E M B E R 1 9 6 6

SUNDAY	MONDAY	TUESDAY	WEDNESDAY	THURSDAY	FRIDAY	SATURDAY
<p>Without self-respect there can be no genuine success. Success won at the cost of self-respect is not success—for what shall it profit a man if he gain the whole world and lose his respect." —B.C. Forbes</p> <p>Every one is never so agreeable as to our blind side; commend a fool for his wit, or a knave for his honesty, and they will receive you into their bosom." —Henry Fielding</p>				1 PTA Ex. Bd. Mt., Clear Stream, 8:15 p.m.	2	3
4	5 V.S. Council of PTA Meeting, Howell Road School	6 Parent's Night, Memorial, South, Central	7 Pre-school Mt., Child., Miss Ritzenthaler; Pars., Miss Barbone 2:30 p.m. PTA Ex. Bd. Mt., Forest, 8:30 p.m.	8	9	10
11	12	13 C.H.S. Board Meeting, 8 p.m.	14	15	16	17
18	19	20 Dist No. 30 Board of Ed. Mt., 8:15 p.m. REPORT CARDS SENT OUT TODAY	21 PTA Holiday Gift to Children, Forest	22 PTA Holiday Assembly for Children, Clear Stream	23 CHRISTMAS RECESS SCHOOL CLOSED	24 CHRISTMAS RECESS
25 CHRISTMAS RECESS	26 CHRISTMAS RECESS	27 CHRISTMAS RECESS	28 CHRISTMAS RECESS	29 CHRISTMAS RECESS	30 CHRISTMAS RECESS	31 CHRISTMAS RECESS

FOREST ROAD PARENT TEACHER ASSOCIATION

ELECTED OFFICERS 1966-1967

President	Arline Glass	PY 1-8088
First Vice President	Marjorie Grauer	PY 1-6043
Second Vice President	Eleanor Klein	PY 1-3060
Third Vice President	Gertrude Myron	PY 1-2386
Treasurer	Lynn Kimelman	PY 1-5356
Financial Secretary	Wilma Baron	PY 1-8159
Corresponding Secretary	Ceil Barnett	PY 1-8114
Recording Secretary	Helga Schwartz	PY 1-8459
Delegate to Council	Phyllis Abelov	PY 1-7951
Delegate to Council	Miss Jean Ritzenthaler	Faculty

COMMITTEE CHAIRMEN

Budget	Lynn Kimelman	PY 1-5356
Class Mother	Corky Shaw	PY 1-8807
Class Mother	Edith Morenstein	PY 1-8240
Family Living (Mental Health, Parent Ed., Excep. Child)	Ora Haines	PY 1-6647
Flyers	Irene Polokoff	PY 1-4098
Good Will & Hospitality	Pompi Macleod	PY 1-7072
	Beth Stern	PY 1-2585
Health & Safety	Ruth Weinstein	PY 1-9045
	Irene Haupt	PY 1-5471
Historian	Kaley Stern	PY 1-5823
Legislation	Lawrence Schoen	PY 1-6627
Library & Book Fair	Fran Ozga	PY 1-5865
	Emma Bremen	PY 1-5070
Membership	Marion Miller	PY 1-7180
Mimeograph	Felice Pester	PY 1-5414
Music & Art	Claire Weinberg	PY 1-3656
Parliamentarian	Jack Klein	PY 1-3060
Pre-School	Sally Newman	PY 1-6743
Publications	Fanette Clapman	PY 1-3009
Publicity	Lillian Spector	PY 1-2627
School & Comm. Relations	Lois Apfelbaum	PY 1-4468
School Bd. Rep.-Elem.	Jack Klein	PY 1-3060
School Bd. Rep.-H.S.	Miss Jean Ritzenthaler	
Teacher Rep.		
Typist		
Ways & Means	Muriel Roth	PY 1-4090
	Barbara Ostrow	PY 1-3616
	Gloria Weinberger	PY 1-3182
	Phyllis King	PY 1-7766
	Caroline Green	PY 1-7946
	Leah Berger	PY 1-3768
	Marcia Chalet	PY 1-2641
	Lillian Spector	PY 1-2627
	Debra Zarcky	PY 1-4029
	Pompi Macleod	PY 1-7072
Youth & Recreation		
Newsletter Staff—Editor		
Reporter		
Publicity		
Typist		
Art Work		

P.T.A. PROGRAM

Aug. 31	Board meeting at Arline Glass' house, 8:30 p.m.
Sep. 7-8	PTA sale of school supplies. Sale starts at 3:00 p.m.
21	General Membership Meeting, 8:30 p.m. "Getting to Know You." Grade teas.
Oct. 5	Executive Board Meeting, 8:30 p.m.
19	Gen. Membership Mtg., 8:30 p.m. "Values—Suburban Style!"
21	PTA movie for children, 1:00-2:30 p.m.
28	PTA Cake Sale
Nov. 2	Executive Board Meeting, 8:30 p.m.
9	Pre-School, 3:00 p.m. Mrs. Reinken "Let's Get Acquainted"
16	Gen. Membership Mtg., 8:30 p.m. "Your Children's Values."
Dec. 7	Pre-School, 2:30 p.m. Miss Ritzenthaler—Part I, "Fun With Art." Miss Barbone, Reading Consultant, talks to parents.
7	Executive Board Meeting, 8:30 p.m.
21	PTA's holiday gift to children at assembly.
Jan. 4	Executive Board Meeting, 8:30 p.m.
11	General Membership Meeting, 3:00 p.m. "Citizens Now—Voters Soon." Pre-School, 2:30 p.m. Part II, "Fun With Art."
21	PTA Hootenanny, Sat., 7:00-9:30 p.m.
Feb. 1	Executive Board Meeting, 8:30 p.m.
7	Pre-School, 3:00 p.m. "Make Merry Music"—Miss Butler. Parents with Mrs. Reinken.
16	Founder's Day, 8:30 p.m. Shaw Avenue School.
March 1	Executive Board Meeting, 8:30 p.m.
15	General Membership Meeting, 8:30 p.m. "What Are Your Children Reading?"
April 5	Pre-School, 2:00 p.m. "Storytime" with Mrs. Agree. Speech therapist talks to parents.
5	Executive Board Meeting, 8:30 p.m.
10	Sex Hygiene, 8:30 p.m. Parents of 6th graders invited.
11	Sex Hygiene—5th grade girls
12	Sex Hygiene—6th grade girls and mothers, 8:00 p.m.
13	Sex Hygiene—6th grade boys and fathers, 8:00 p.m.
19	Pre-School, 3:00 p.m. "Free Play." Children with Mrs. Reinken. Parents with Mrs. Salerno.
May 3	Executive Board Meeting, 8:30 p.m.
25	General Membership Meeting, 8:30 p.m. "Installation of Officers."
June 7	Joint Board Meeting, 8:30 p.m.

JANUARY 1967

SUNDAY	MONDAY	TUESDAY	WEDNESDAY	THURSDAY	FRIDAY	SATURDAY
1	2	3	4	5	6	7
MAS RECESS	CHRISTMAS RECESS	SCHOOL REOPENS	PTA Ex. Bd. Mt., Shaw PTA Ex. Bd. Mt., Forest, 8:30 p.m.	PTA Ex. Bd. Mt., Clear Stream, 8:15 p.m.		
8	9	10	11	12	13	14
		C.H.S. Board Meeting, 8 p.m.	PTA Gen. Mt., Forest 3 p.m.; Pre-school Mt., Chil., Miss Ritzenthaler; Parents, Miss Barbone, Forest, 2:30 p.m.			
15	16	17	18	19	20	21
		Joint Boards Mt., Wm. L. Buck School, 8:15 p.m.		PTA Reg. Mt., Clear Stream, 3:15 p.m.		Hootenanny— 7-9:30 p.m., Gym, Forest
22	23	24	25	26	27	28
		Dist. No. 30 Board of Education Mt., 8:15 p.m.				Children's Theater— Central H.S., "African Festival."
29	30	31	<p>"A community whose life is not irrigated by art and science, by religion and philosophy, day upon day, is a community that exists half alive." —Lewis Mumford</p> <p>"The measure of success is not whether you have a tough problem to deal with—but whether</p>			

SCHOOL ADMINISTRATION

Harry S. Gross, District Superintendent
 Sherwood S. Quick
District Principal

SCHOOL PRINCIPALS

CLEAR STREAM AVENUE SCHOOL
 Lawrence O. Lobdell

FOREST ROAD SCHOOL
 Maurice E. St. Mary

SHAW AVENUE SCHOOL
 John A. Busch

George W. Niederhauser, *Assistant Principal*

Elementary Consultant
 William Van Ness

SCHOOL SECRETARIES

Mrs. Jeanne Feeney, Clear Stream Avenue
 Mrs. Mary McDowell, Forest Road
 Mrs. Jean Annona, Shaw Avenue

DISTRICT SECRETARIAL STAFF

Margaret Bradley Lucy Felice Helen Kuchler
 Finnie O'Connell Marcella Pantaleo Mary Ribando
 Edythe Sanchez Caroline Young

DISTRICT SPECIALISTS AND SPECIAL TEACHERS

Frank DeMarco, Audio-Visual Consultant
 Rosalyn Kessler, Psychologist
 Edith Lauten, Psychologist
 Raydine Teicheira, Speech Consultant
 Rebecca Moskowitz, Speech Teacher
 Agnes Mabry, Reading Consultant
 Dolores Stein, Foreign Language Consultant
 Lawrence Cid, Mathematics Consultant
 John Price, Instrumental Music Teacher
 Gilbert Jacobson, Instrumental Music Teacher
 Joan Henningsen, Physical Education Teacher
 Cathleen Meneilly, Special Counselor

OTHER SPECIALISTS AND SPECIAL TEACHERS

Clear Stream Avenue School

Janet Poppe, Reading Specialist
 Grace Giacobone, Art
 Philip Hessemer, Physical Education
 Susan Roemer, Music
 Ruth Newman, Librarian
 Edna Giebel, Nurse-teacher

Forest Road School

Ada Barbone, Reading Specialist
 Jean Ritzenthaler, Art
 Alfred Stevens, Physical Education
 Frances Butler, Music
 Rose Agree, Librarian
 Edna Salerno, Nurse-teacher

Shaw Avenue School

Noel Giambalvo, Special Counselor
 Jeanne Colton, Reading Teacher
 Louise Holbrook, Art
 Linda Maxwell, Art
 Joseph Reynolds, Physical Education
 Joan Kurman, Physical Education
 Katherine Egan, Music
 Felicia Karolyi, Music
 Sylvia Berkowitz, Librarian
 Dorothy McCutchan, Nurse-teacher

FEBRUARY 1967

SUNDAY	MONDAY	TUESDAY	WEDNESDAY	THURSDAY	FRIDAY	SATURDAY
			1 PTA Ex. Bd. Mt., Shaw PTA Ex. Bd. Mt., Forest, 8:30 p.m.	2 PTA Ex. Bd. Mt., Clear Stream, 8:15 p.m.	3	4
5	6 V.S. Council of PTA Mt., Corona Ave. School	7 Pre-school Mt., "Make Merry Music," Children with Miss Butler, Par- ents with Mrs. Reinken, Forest, 3 p.m.	8	9 PTA Fund Raiser, Chinese Auction, Clear Stream, 8 p.m.	10	11
12 N'S BIRTHDAY	13 LINCOLN'S BIRTHDAY SCHOOL CLOSED	14 C.H.S. Board Mt., 8 p.m.	15 REPORT CARDS SENT OUT TODAY	16 PTA Founder's Day Program at Shaw for all three schools	17	18
19	20	21 Joint Boards Meeting, Wm. L. Buck School 8:15 p.m.	22 WASHINGTON'S BIRTHDAY SCHOOL CLOSED	23 Pre-school Tour, Clear Stream, 3 p.m.	24	25
26	27	28 Dist. No. 30 Board of Education Meeting, 8:15 p.m.	"EXPERIENCE: What you get while looking for something else." "Democracy is based on the conviction that there are extraordinary possibilities in ordinary people." —Harry Emerson Fosdick			

THE ROLE OF THE SPECIALIST

District Thirty has been indeed fortunate that its residents want the best for their children. Wanting the best, they have voted the necessary money to allow the district to provide specialists in addition to the needed classroom teachers. These specialists augment and aid the teachers in doing a better job for all pupils.

Working as a team, there are ten specialists. They include two guidance consultants, two part-time psychologists, four reading persons and two speech persons.

They function in the following manner:

Guidance Consultants — counsel pupils who are recommended to them by the classroom teachers and the administration. It may be because they are not achieving success in academic areas, because they are having trouble getting along with others, or because of many other reasons.

Psychologists — administer individual tests, interview teachers, consultants, and parents and on the basis of their findings, recommend procedures for teachers to use in the classroom to satisfy individual pupil needs. They also make referrals to outside agencies for some pupils.

Reading Consultant and Specialists — includes four members — one reading consultant and three reading specialists. The reading consultant coordinates the work of the reading specialists. Each specialist is assigned to a building where she is responsible, under the direction of the reading consultant, for teacher workshops, diagnostic testing, consultations with teachers, and remedial reading instruction.

Speech Consultant and Speech Teacher — the two members of this department perform two services. First, they conduct a developmental speech program in the kindergartens, coordinated with the reading readiness program, and second, they have a speech correction program for children having such a need.

The work of all these specialists is coordinated by the Elementary Consultant, who conducts weekly meetings with them, at which time individual pupils are discussed as to their progress, or lack of it, and further plans may be made on how to handle these special cases. *The emphasis is on the child*, and it is felt that all specialists working together as a team will surely prove of benefit to the child so that every pupil will have the opportunity to progress to the utmost of his ability.

MARCH 1967

SUNDAY	MONDAY	TUESDAY	WEDNESDAY	THURSDAY	FRIDAY	SATURDAY
way to curb delinquency is to take the parents off the streets it." rtunes one can endure, they come from outside, they are acci- But to suffer for one's own faults, ah! there is the sting of —Oscar Wilde			1 PTA Ex. Bd. Mt., Forest, 8:30 p.m.	2 PTA Ex. Bd. Mt., Shaw and Clear Stream, 8:15 p.m.	3	4
5	6	7 PTA Afternoon Mt., Shaw Avenue	8	9 PTA Fashion Show, Shaw Avenue	10 PTA Father, Son & Daughter Nite, Clear Stream, 7:30 p.m.	11 Children's Theater— Central H.S., "Johnny Appleseed"
12	13	14 C.H.S. Board Meeting, 8 p.m.	15 PTA Gen. Mt., "What Are Your Children Reading," Forest, 8:30 p.m.	16 PTA Reg. Mt., Clear Stream, 3:15 p.m.	17	18
19	20	21 Dist. No. 30 Board of Education Meeting, 8:15 p.m.	22	23 EASTER RECESS SCHOOL CLOSED	24 EASTER RECESS	25
26	27	28	29	30	31	

SCHOOL POLICIES

SCHOOL HOURS

The hours for grades 1, 2, and 3 are from 9:00 a.m. to 3:00 p.m.
The hours for grades 4, 5, and 6 are from 8:30 a.m. to 2:45 p.m.

LUNCH

Lunch is served beginning with the first day of school. Pupils may come for lunch, bring lunch from home, or buy the school lunch in the cafeteria for 25c. Monthly menus are provided so that if foods are served which your child does not eat, you can make other provisions for him for those days. In case a child forgets his lunch money or his lunch, or loses either, we have a charge system to cover the emergency. The cashier in the cafeteria keeps the record of such charges and contacts the parents should a charge not be paid in a reasonable time.

ICE CREAM

Ice cream is sold daily to those pupils who wish it. It is not part of the hot lunch and costs an additional 10c.

RECESS MILK

Recess milk is available to all children beginning about the third week of the school year and is sold at a cost of 15c per week available each Thursday for the following week. You will be notified as to the exact date. Money brought in late (Friday) cannot be accepted. In case of a child's absence, no refund is made for periods of less than a full week.

ABSENCES

When your child has been absent, State law requires that he bring a note from you explaining the absences and the date(s) of absence(s). The note should be presented to the nurse before he goes to the classroom. Please be specific. Just saying, "he was ill," is not enough. Indicate whether it was "virus," "fever," "cold," etc. A note is required for an absence due to a religious holiday. A note is required for any tardiness, giving the reason. If your child contracts a contagious disease, such as mumps, measles, etc., please phone the school nurse so that she can alert the parents in your child's class that their children have been exposed. Be sure to keep the emergency card up to date so that we will know whom to call should your child become ill and have to go home.

NOON HOUR RULES

When pupils misbehave in the cafeteria, auditorium, or on the playground during the noon hour, after repeated reminders, the teachers have the authority to exclude them from staying in school for lunch for a few days, or longer, depending on the misbehavior. If you receive such a note from us, we would appreciate your cooperation. Whether or not a mother is home during the noon hour has no bearing on this exclusion.

RELEASED TIME FOR RELIGIOUS INSTRUCTION

A Release Form signed by the parent is necessary should you want your child excused from school for religious instruction. Such forms can be obtained from your church. The time provided is the last hour of school on Wednesday afternoons.

EXITS AND ENTRANCES

Your child's class is assigned a specific exit and entrance to use. You will thus know where to meet him if you come to pick him up. Parents picking up children are asked to meet them at the exit, not the classroom.

ENTRANCE TIMES

Primary grade children (Grade 1-3) are not allowed to enter the building before 8:50 a.m. and 12:50 p.m. at Shaw and Forest, and at 8:50 and 12:55 at Clear Stream, except that in inclement weather they may come into the designated area five minutes before the above times. For this reason and because there is no supervision of the playground in the morning, we suggest you arrange your child's departure from home to allow him to arrive just in time to enter the building during the proper interval. Intermediate grade children (Grades 4-6) are not allowed to enter before 8:20 a.m. The teachers assign line-up areas on the playground for the various classes after school has begun in September.

CLASS INTERRUPTIONS

No unnecessary interruptions of classes are allowed once the day's sessions have begun. When your child forgets a book, homework, sneakers, lunch money, etc., please bring these to the office. All pupils are instructed to check with the office at lunch time for such forgotten items. In the interest of the child's all-round education, we urge you not to make a practice of bringing forgotten items to school. The child should be developing his own sense of responsibility for these things.

APRIL 1967

SUNDAY	MONDAY	TUESDAY	WEDNESDAY	THURSDAY	FRIDAY	SATURDAY
	CHILDREN LEARN WHAT THEY LIVE					
a child lives with criticism, He learns to condemn, a child lives with hostility, He learns to fight, a child lives with ridicule, He learns to be shy,	If a child lives with tolerance, He learns to be patient, If a child lives with encouragement, He learns confidence,	If a child lives with praise, He learns to appreciate, If a child lives with fairness, He learns justice, If a child lives with security, He learns to have faith,	If a child lives with approval, He learns to like himself, If a child lives with acceptance and friendship, He learns to find love in the world.			1
2	3	4	5	6	7	8
	SCHOOL REOPENS V.S. Council of PTA Mt., Forest Road School		PTA Ex. Bd. Mt., Shaw and Forest Pre-school Mt., Forest, Story time, Mrs. Agree; Speech tchr, Parents	PTA Ex. Bd. Mt. Clear Stream, 1:15 p.m.		
9	10	11	12	13	14	15
	Sex Hygiene Mt., 6th Grade parents, Forest, 8:30 p.m.	C.H.S. Bd. Mt., 8 p.m. Sex Hygiene Mt., 5th Grade girls, Forest, 8:30 p.m.	REPORT CARDS SENT OUT TODAY PTA Party, Shaw Sex Hygiene Mt., 6th Grade girls & Mothers, Forest, 8:30 p.m.	Mental Health, 5th Grade girls, Clear Stream, 3 p.m. Sex Hygiene Mt., 6th Grade boys & Fathers, Forest, 8:30 p.m.	Reg. for next year's Kindergarten, each sch. 9:15 to 3 p.m.	
16	17	18	19	20	21	22
		Dist. No. 30 Board of Education Meeting, 8:15 p.m.	PTA Workshop, Shaw PTA Cake Sale, Cl. St., 2:45 p.m.; Pre-school Mt., children & Parents Forest, 3 p.m.		PTA Mental Health, 6th Grade, Clear Stream, 7:30 & 8 p.m.	Registration for school voting, 7 a.m. to 12 Noon
23	24	25	26	27	28	29
30				Registration for school voting, 4 to 10 p.m.		

SCHOOL POLICIES

GYM SUITS AND SNEAKERS

Gym suits are required of pupils below the 4th grade, but sneakers are necessary for any pupils using the gym. Boys and girls from the 4th through 6th grades are required to wear gym suits and sneakers on the assigned gym days. The gym teachers will explain this to the pupils, but many times they do not bring the correct information home.

Girls who **MUST PURCHASE A NEW SUIT** should buy the two-piece ROYAL BLUE, bloomer type, with elastic bottoms, or ROYAL BLUE shorts with elastic insert in the cuff, and a white blouse. Boys should wear ROYAL BLUE shorts, with elastic top, sneakers (high top ones preferred), and white or SCHOOL "T" shirts.

IF A CHILD HAS ANOTHER COLOR, OR TYPE, HE DOES NOT HAVE TO BUY A NEW ONE. The above apparel may be purchased at many local stores in Valley Stream. **NO ONE IS ALLOWED ON THE GYM FLOOR WITHOUT SNEAKERS.**

APPOINTMENTS WITH TEACHERS

In order that pupils' classtime be used to the fullest advantage, we request that parents do not seek conferences with teachers during school hours. If you wish a conference, please make an appointment to see the teacher after school. Teachers are available for such conferences every day except Mondays and Fridays.

BICYCLES

Bicycles are allowed at either Forest Road or Clear Stream Avenue Schools because no child lives far enough from the school to make them necessary. They are allowed at Shaw, but are restricted to pupils in grades 4, 5, and 6 who live NORTH OF CROFTON AVENUE. Bicycles used to come to the Shaw Avenue School will be assigned a number. All must have a lock and chain for safety purposes.

GIFTS TO TEACHERS PROHIBITED

The policy of the school district which became effective January 1956, is to prohibit the acceptance of gifts by faculty members on school premises, and to prohibit the solicitation of funds for personal gifts purposes, by any person, or persons, on the premises.

IN-DAY PROGRAM

In inclement weather, there is an in-day program of motion pictures provided for those pupils who eat in the cafeteria. Pupils who go home to lunch are not allowed to participate in this program because of space limitations, so we ask parents to return these pupils to school on such days just in time for the afternoon session—not before 12:50 p.m. for grades 1 to 3, and 12:20 p.m. for grades 4 to 6 at Shaw and Forest; and not before 12:55 for grades 1 to 3 and 12:15 for grades 4 to 6 at Clear Stream.

HOMEWORK REQUIREMENTS

Homework is required of all pupils, but it will vary from day to day. First and second grade pupils may have fifteen to twenty minutes of homework per day, while third and fourth grade pupils are likely to have thirty to forty minutes. Fifth and sixth graders are expected to devote as much as an hour to homework, but again this may not be every day—it will depend on the pupil and his needs.

LOST AND FOUND

Unmarked articles lost by pupils are placed in the Lost-and-Found, which is in the Nurse's Office. Such articles, if not claimed at the end of the school year, are given to a charitable organization. However, any articles bearing a child's name is returned directly to him. Please place your child's name on all his belongings.

STAYING AFTER SCHOOL

To eliminate any confusion or problems, the school may have your child every day for an additional half hour. During this half hour beyond the regular school day, the teacher may schedule your child for special help or keep him for any of several reasons. We ask that you keep this in mind and not schedule dental appointments, dancing lessons, etc. until after that interval. Teachers are also available to parents during the half hour after school, except on Monday and Friday, for conferences. Appointments are not necessary, but it is to your advantage to make one, so that you can be sure of the teacher's availability.

ASSEMBLIES

When your child's class puts on the assembly, we welcome your attendance, but we do ask you not to bring pre-school children. As much as we realize that it is a thrill for them to see big brother perform, they are often distracting to all concerned.

MAY 1967

SUNDAY	MONDAY	TUESDAY	WEDNESDAY	THURSDAY	FRIDAY	SATURDAY
	1	2	3 VOTING ON SCHOOL BUDGET 7 a.m. to 10 p.m. PTA Ex. Bd. Mts., Shaw & Forest, 8:30 p.m. and Clear Stream, 3 p.m.	4	5	6
7	8	9 C.H.S. Board Meeting, 8 p.m.	10	11 PTA Pre-school wkshp., Clear Stream, 8 p.m.	12	13
14	15	16 Art Exhibit, Clear Stream, 7:30 to 9 p.m. Jr. Bd. Mt., Wm L. Buck, 8:15 p.m. Tchr. Recognition Day	17 Teacher Recognition Luncheon, Shaw REPORT CARDS SENT OUT TODAY PTA Reg. Mt., Shaw	18 Art Exhibit, Forest, 7:30 to 9 p.m.	19	20
21	22 Reg. for next year's Kindergarten, each sch. 9:15 to 3 p.m.	23 Dist No. 30 Board of Education Meeting, 8:15 p.m.	24	25 Art. Ex., Shaw, 7:30 to 9 p.m.; PTA Mts., Cl. St. & For., 8:15 p.m. Tchr. Recog. Lnchn, Forest, 11:30 to 1 p.m.	26	27
28	29	30 MEMORIAL DAY	31	"Schedule all your worrying for a specific half hour about the middle of the day. Then take a nap during that period." "The wise know too well their own weakness to assume infallibility;"		

THE ADMINISTRATIVE TEAM

Unlike many other school districts, District Thirty operates not as individual school buildings but as "one school in four buildings." This is accomplished in many ways but primarily by team approaches to various aspects of the school program. The page over the month of March discussed one of these teams. This page is devoted to another of our teams — the administrative team.

The administrative team consists of the District Principal, the three building principals, and the elementary consultant.

This group supervises teaching, curriculum development, and all other aspects of the instructional program throughout the district. For instance, though the building principals are administrators in charge of their own buildings, they observe, besides their own teachers, the teachers in the other buildings in the district. Not only does this give all teachers more than adequate supervision, it gives all the administrators a good knowledge of the capabilities of all the teachers and some good ideas to carry to other teachers from one school building to another.

In addition, administrators, each having a different background, are charged with the responsibility for supervising curriculum committees of one type or another. These are formed as the need becomes apparent that some curriculum area has changed, and revisions are necessary. On the average two of these committees are in operation every school year. The administrator acts as the liaison between the committee and the other administrators.

Teachers meet by grade-level several times each school year and an administrator is assigned to each group, again to act as a liaison person.

The administrator group meets weekly and at these meetings problems are brought forth and solutions sought. It is at this time that coordination of all aspects of the school program is effected and is one main reason for our saying that we have "one school in four buildings."

JUNE 1967

UNDAY	MONDAY	TUESDAY	WEDNESDAY	THURSDAY	FRIDAY	SATURDAY
<p>best place to spend your vacation is just inside your income."</p>				1	2	3
<p>ation: That mysterious process whereby information passes from the lecture notes of professor through the fountain pen and onto the notebook of the student, without going through the minds of either." —Hamilton Holt</p>	4	5 V.S. Council of PTA mt., Memorial Jr. H.S.	6	7 PTA Ex. Bd. Mt., Shaw PTA Joint Board Mt., Forest, 8:30 p.m.	8 PTA Joint Board Mt., Clear Stream, 8:15 p.m.	9
		10				
11	12	13 C.H.S. Board Meeting, 8 p.m.	14	15	16	17
18	19	20	21 GRADUATION	22	23 LAST DAY OF SCHOOL	24
25	26	27 Dist. No. 30 Board of Education Meeting, 8-11 p.m.	28	29	30	

UNION FREE SCHOOL DISTRICT No. 30 AND
 CENTRAL HIGH SCHOOL DISTRICT No. 1,
 VALLEY STREAM, NEW YORK

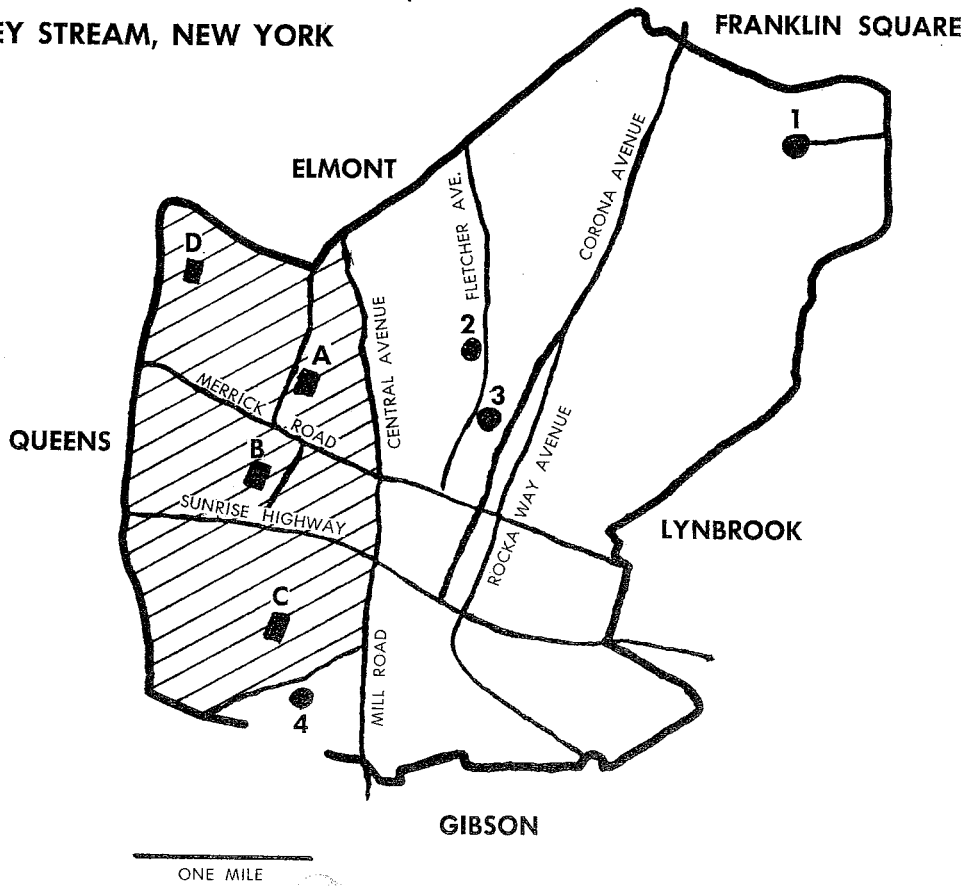

DISTRICT No. 30 SCHOOLS

- Shaw Avenue A
- Clear Stream Avenue B
- Forest Road C
- Washington Avenue D

Shaded Area — District 30

HIGH SCHOOLS

- North High 1
- Memorial Junior 2
- Central High 3
- South High 4

JULY 1967

SUNDAY	MONDAY	TUESDAY	WEDNESDAY	THURSDAY	FRIDAY	SATURDAY
motherhood: what a woman experiences when all the kids are in bed." "There is nothing wrong with the younger generation that the older generation didn't outgrow." "Child guidance is what more and more parents are getting from their children."						1
2	3	4 INDEPENDENCE DAY	5	6	7	8
9	10	11 School Board Reorganization Meeting C.H.S. Board of Ed. Meeting, 8 p.m.	12	13	14	15
16	17	18	19	20	21	22
23	24	25 Dist. No. 30 Board of Education Meeting,	26	27	28	29
30	31					

CLEAR STREAM AVENUE SCHOOL

CLASS MOTHER LIST

Grade	Room	Class Mother	Tel. Number	Teacher
		Elaine Kirchmann LO 1-7353	Lillian Serpico LO 1-0117	
		Marilyn Kavitt CO 2-9122	Irene Pederson VA 5-0374	
K (8:30)	9	Gloria McCarren	CU 5-8448	Miss Blessinger
(8:30)	9	Grace Seidler	LO 1-9173	Miss Blessinger
11:00	9	Mildred Brennan	872-8354	Miss Eden
11:00	9	Marie Pascuzzi	VA 5-8401	Miss Eden
(1:30)	9	Josephine Coyle	CU 5-7731	Miss Eden
K (1:30)	9	Dorothea Munson	LO 1-2547	Miss Eden
1	B	Ann Prisco	CU 5-5744	Mrs. Schaaf
1	B	Anne Planco	LO 1-2218	Mrs. Schaaf
1	7	Norma Rodriguez	LO 1-1382	Mrs. Williams
1	7	Ruth Novak	CO 2-4363	Mrs. Williams
1	8	Eva Sasiene	CU 5-7695	Mrs. Koubek
1	8	Beatrice Braun	LO 1-1155	Mrs. Koubek
2	2	Rose Vespucci	LO 1-2962	Mrs. Guberman
2	2	Lillian Crescuolo	CU 5-7839	Mrs. Guberman
2	5	Kay Schmidt	872-8692	Mrs. Galati
2	5	Mary Tragner	CU 5-9502	Mrs. Galati
2	6	Irene Kielawa	LO 1-1075	Mrs. Ugenti
2	6	Martha Keller	VA 5-3171	Mrs. Ugenti
3	1	Isabel Fischetti	CU 5-7500	Miss Firpo
3	1	Marilyn Margolies	CU 5-8973	Miss Firpo
3	3	Rose Paladino	CU 5-8405	Mrs. Copersino
3	3	Veronica Salvaggio	LO 1-8194	Mrs. Copersino
3	4	Gloria Corradi	CU 5-5255	Miss LeJeune
3	4	Josephine Balsano	CU 5-9700	Miss LeJeune
4	23	Ruth Kane	LO 1-0865	Miss Galbraith
4	23	Doris Moser	VA 5-1596	Miss Galbraith
4	25	Frances Battista	CU 5-6484	Miss Yelland
4	25	Doris Horowitz	CO 2-2865	Miss Yelland
4	27	Patricia DeMayo	VA 5-5290	Miss Tracy
4	27	Jennie Longo	285-5634	Miss Tracy
5	24	Ann Snider	CU 5-7302	Miss Pincus
5	24	Eleanor Lacerra	CU 5-8211	Miss Pincus
5	26	Miriam Cohen	CO 2-9330	Mrs. McCloskey
5	26	Muriel Schult	CU 5-8631	Mrs. McCloskey
5	28	Jane Klasmeier	CU 5-5811	Mrs. Wicht
5	28	Rae Capp	CU 5-7464	Mrs. Wicht
6	21	Dee O'Leary	VA 5-5943	Mr. McNiven
6	21	Doris Hamilton	CU 5-9417	Mr. McNiven
6	21	Martha DeKnatel	CU 5-7310	Mr. McNiven
6	22	Muriel Watterson	CO 2-5478	Miss Bergler
6	22	Mary Visconti	CU 5-7947	Miss Bergler
6	22	Muriel Schult	CU 5-8631	Miss Bergler

FOREST ROAD SCHOOL

CLASS MOTHER LIST

Corky Shaw and Edith Morenstein, *Class Mother Chairmen*

Grade	Room	Class Mother	Tel. Number	Teacher
K	AM	201 Ann Berger	PY 1-4088	Mrs. Reinken
K	AM	201 Marcia Balaban	PY 1-7598	Mrs. Reinken
K	AM	201 Charlotte Hellreich	PY 1-4093	Mrs. Reinken
*K	PM	201 Elaine Waldman	PY 1-3140	Mrs. Reinken
K	PM	201 Marilyn Fogel	PY 1-4701	Mrs. Reinken
K	PM	201 Pearl Lustbader	PY 1-9854	Mrs. Reinken
1		202 Phyllis Abelow	PY 1-7951	Mrs. Deitrich
1		202 Arlene Mandel	PY 1-4967	Mrs. Deitrich
1		203 Elaine Adelstein	PY 1-2246	Miss Cafiso
*1		203 Iris Casson	PY 1-4727	Miss Cafiso
2		204 Lillian Spector	PY 1-2627	Miss Landi
2		204 Carol Andiman	PY 1-4686	Miss Landi
2		205 Beverly Brosterman	PY 1-7021	Miss Perrich
2		205 Claire Weinberg	PY 1-3656	Miss Perrich
*2		206 Diane Kahn	PY 1-4756	Miss Post
2		206 Nancy Walters	PY 1-8080	Miss Post
2		207 Marilyn Thorner	PY 1-5274	Mrs. Cummings
2		207 Beulah Kauderer	PY 1-8954	Mrs. Cummings
2		209 Estelle Cohen	PY 1-7637	Miss Clark
*3		209 Ruth Weinstein	PY 1-5377	Miss Clark
*4		208 Eileen Silver	PY 1-2060	Miss Bendin
4		208 Elaine Lieberthal	PY 1-5098	Miss Bendin
4		210 Marlene Schoen	PY 1-6227	Miss Duck
4		210 Irene Haimes	PY 1-9314	Miss Duck
4		211 Barbara Taylor	PY 1-7730	Miss Nancken
4		211 Audrey Karpow	PY 1-5464	Miss Nancken
4		214 Marge Blumenkoph	PY 1-6581	Mr. Kaufmann
4		214 Loretta Shuman	PY 1-5972	Mr. Kaufmann
*5		215 Eleanor Haber	PY 1-6678	Mrs. Parker
5		215 June Blum	PY 1-7521	Mrs. Parker
5		216 Renee Zeluck	PY 1-8362	Miss Ackerman
5		216 Nina Weitzner	PY 1-9615	Miss Ackerman
6		217 Elaine Seltzer	PY 1-7337	Mrs. Kalsmith
*6		217 Phyllis King	PY 1-7766	Mrs. Kalsmith
6		217 Barbara Shulman	PY 1-7556	Mrs. Kalsmith
*6		218 Carolyn Green	PY 1-7946	Mrs. Melnick
6		218 Gerry Siegel	PY 1-7559	Mrs. Melnick
6		218 Miriam Kaplan	PY 1-2265	Mrs. Melnick
6		219 Esther Skolnik	PY 1-7427	Mr. Cooper
6		219 Rhoda Fleischer	PY 1-3290	Mr. Cooper
6		219 Eleanor Klein	PY 1-3060	Mr. Cooper
6		220 Celia Kushner	PY 1-5709	Mrs. Stalb
6		220 Lee Straus	PY 1-4085	Mrs. Stalb
6		220 Francine Chardanet	PY 1-5161	Mrs. Stalb

*Grade Coordinator

AUGUST 1967

SUNDAY	MONDAY	TUESDAY	WEDNESDAY	THURSDAY	FRIDAY	SATURDAY
		1	2	3	4	5
Appeaser is one who feeds a crocodile and it will eat him last." —Winston Churchill						
6	7	8	9	10	11	12
C.H.S. Board of Ed. Meeting, 8 p.m.						
13	14	15	16	17	18	19
20	21	22	23	24	25	26
Dist. No. 30 Board of Ed. Meeting, 8:15 p.m.						
27	28	29	30	31	"I believe I've found the missing link between animal and civilized man. It is us." —Dr. Konrad Lorenz	

SHAW AND WASHINGTON AVENUE SCHOOLS

CLASS MOTHER LIST

Grade Representative Co-ordinator Mrs. Joanne Evans, CU 5-8393

Room	Class Mother	Tel. Number	Teacher
Kindergarten Representative	Mrs. Marie DiGiamo	LO 1-0079	
301 AM	Mrs. M. Entwistle	CU 5-7099	Mrs. Hartman
301 PM	Mrs. B. Donnelly	CU 5-9508	Mrs. Hartman
101 AM	Mrs. E. Cannizaro	825-9037	Miss Willigan
101 PM	Mrs. M. Catalfomo	VA 5-2225	Miss Willigan
102 PM	Mrs. M. DiGiamo	LO 1-0079	Miss Blessinger
First Grade Representative	Mrs. Jo Diaz	CU 5-6126	
103	Mrs. J. Robson	825-0598	Mrs. Levine
106	Mrs. W. Poche	VA 5-2742	Miss Dikeman
302	Mrs. S. Goldfisher	CU 5-6227	Mrs. Kraft
303	Mrs. M. Coppola	CU 5-8032	Mrs. Lazar
Second Grade Representative	Mrs. Edith Wolff	CU 5-7552	
104	Mrs. E. Wolff	CU 5-7552	Miss Wallace
105	Mrs. S. Schlaeger	CU 5-7588	Miss Davis
126	Mrs. S. Bernunzo	LO 1-1653	Miss Santoro
130	Mrs. E. Thomas	CO 2-2479	Mrs. Paradiso
133	Mrs. W. Heidt	825-7788	Mrs. Colletti
Third Grade Representative	Mrs. Marie Cecere	VA 5-9406	
107	Mrs. S. Schlaeger	CU 5-7588	Mrs. Strumpf
108	Mrs. H. Seidler	CU 5-7058	Miss Mack
128	Mrs. C. Montana	LO 1-0267	Mrs. Diesl
132	Mrs. M. Drayer	CU 5-6118	Mrs. Stevens
135	Mrs. M. Horazan	CU 5-5706	Mrs. Benedetto

Gr.	Room	Class Mother	Tel. Number	Teacher
Fourth Grade Representative		Mrs. Norma Amitrano	CO 2-5508	
4	109	Mrs. M. Balaban	CU 5-5853	Mrs. Braunstein
4	110	Mrs. E. Drucker	CU 5-9677	Mr. Riccobono
4	111	Mrs. Z. Block	CU 5-8428	Mrs. Barnaby
4	112	Mrs. M. Michiewicz	VA 5-1607	Mrs. Pokorny
Fifth Grade Representative		Mrs. Donnie Gally	VA 5-6206	
5	114	Mrs. R. Barraco	825-3848	Miss Harris
5	116	Mrs. L. Feldman	CU 5-7833	Miss Schwartz
5	117	Mrs. J. Poche	VA 5-2742	Mrs. Aronin
5	118	Mrs. E. Schultz	LO 1-0852	Mrs. Hamcke
5	122	Mrs. M. Firrello	LO 1-1185	Miss Murray
Sixth Grade Representative		Mrs. Joyce Fisher	LO 1-9675	
		Mrs. Harriet Wolf	CU 5-7350	
6	119	Mrs. S. Deer	285-7974	Mrs. Sherman
6	121	Mrs. T. Barone	CU 5-6240	Mr. Sortino
6	123	Mrs. P. Monachino	VA 5-1218	Miss Lanell
6	124	Mrs. E. Slonim	CU 5-9717	Miss Brown
6	125	Mrs. N. Cohen	VA 5-0903	Mrs. Rosche
6	127	Mrs. M. Bourne	LO 1-8237	Mr. Giacalone
Special				
Cl. 131		Mrs. E. Kinnaird	LO 1-7427	Miss Croley

SCHOOL TELEPHONE DIRECTORY

MAIN OFFICE: SHAW AVENUE SCHOOL
 District Principal VA 5-9131
 Mess Office VA 5-9131
 Media Manager VA 5-9131

Shaw Avenue School

Principal's Office VA 5-9131
 Nurse's Office VA 5-9131

Washington Avenue School

Office VA 5-9131

Stream Avenue School

Principal's Office VA 5-3044
 Media Office VA 5-3044

Special Services

Elementary Consultant VA 5-9131
 Guidance Consultant VA 5-9131
 Psychologist VA 5-9131
 Speech Consultant VA 5-9131
 Reading Consultant VA 5-9131
 Mathematics Consultant VA 5-9131
 Audio-Visual Consultant LO 1-1165

Road School

Principal's Office PY 1-7676
 Media Office PY 1-7676

INDEX

Board of Education see October
 Shaw and
 Washington Avenue PTA see November
 Clear Stream PTA see December
 Forest Road PTA see January
 Administration and
 Special Services see February
 Role of the Specialist see March
 Administrative Team see June
 School Policies see April and May
 Map of District see July
 Clear Stream and
 Forest Class Mothers see August
 Shaw and Washington
 Class Mothers see facing page

CENTRAL HIGH SCHOOL DISTRICT NO. 1
 Telephone Number: VA 5-8642
 Use this number for all high school
 buildings, offices and personnel

NOTES

UNION FREE SCHOOL DISTRICT THIRTY **30**
VALLEY STREAM, NEW YORK

SCHOOL ACTIVITIES

Calendar

FOR 1967-1968

PUBLISHED BY THE BOARD OF EDUCATION AND PARENT-TEACHER ASSOCIATIONS

TELEPHONE DIRECTORY

INDEX

FOR 1967-1968

Calendar

SCHOOL ACTIVITIES

UNION FREE SCHOOL DISTRICT THIRTY
VALLEY STREAM, NEW YORK

30

BOARD OF EDUCATION



Standing (left to right): George Levine*; George Adams, School Attorney; Eleanor Zeller, Board Clerk; Eleanor Berger, Board Treasurer; Sherwood Quick, District Principal. Seated: Robert Bell, President; Elinor McAuliffe*; Nathaniel Altschul*, Vice President; John Achini.

*Also serves on High School Board.

SCHOOL CALENDAR, 1967-1968

Meetings (School District Conference)	Tues., Sept. 5	Christmas Recess	School closes at regular time
.....	Tues., Sept. 5	Thurs., Dec. 21
Day of School	Wed., Sept. 6	School Reopens
Rosh Hashanah	Thurs. & Fri., Oct. 5 & 6	Lincoln's Birthday
.....	Thurs., Oct. 12	Washington's Birthday	Thurs. & Fri., Feb. 22 & 23
Teachers' Conference (N.Y.S. Teachers' Assn.)	Mon., Oct. 23	Easter Recess	School closes at regular time
.....	Tues., Nov. 7	School Reopens
.....	Schools close at end of morning session	Memorial Day	Wed., April 10
.....	Nov. 22	School Closes for Pupils	Mon., April 22
.....	School Reopens	School Closes for Teachers	Thurs. & Fri., May 30 & 31
.....	Nov. 27	Mon., June 2

OCTOBER 1967

SUNDAY	MONDAY	TUESDAY	WEDNESDAY	THURSDAY	FRIDAY	SATURDAY
1	2 V.S. PTA Council Mt. Wm. L. Buck	3 5th & 6th Grade Tea, Clear Stream, 8 p.m. K. & 1st Grade Tea, Shaw & Washington	4 PTA Ex. Bd. Meeting Clear Stream, 1:15	5 ROSH HASHANAH SCHOOL CLOSED	6 ROSH HASHANAH SCHOOL CLOSED	7
8	9	10 C.H.S. Bd. Mt., 8 p.m. Pre-School & K. Tea, Clear Stream, 8 p.m. 2d & 3d Grade Tea, Shaw	11 PTA "Prizo Night" Forest, 8:15 p.m. PTA Exec. Bd. Meeting Shaw, 8:30 p.m.	12 COLUMBUS DAY SCHOOL CLOSED	13	14 YOM KIPPUR
15	16	17 PTA Gen. Mt., Reading Workshop, Forest 2:45 1st & 2nd Grade Tea, Clear Stream, 8 p.m. 4 & 5 Gr. Tea, Shaw	18	19 FIRST DAY OF SUKKOTH	20 SECOND DAY OF SUKKOTH	21
22	23 Teachers' Conference SCHOOL CLOSED Children's Movie, Shaw	24 Dist. No. 30 B. of E. Meeting, 8:15 3d & 4th Grade Tea, Clear Stream, 8 p.m. 6th Gr. Tea, Shaw	25	26 EIGHTH DAY OF SUKKOTH	27 SIMHAT TORAH 6 Grade Hallowe'en Party, Forest	28 Children's Theater Central H.S. "Sam Stiller"
29	30 PTA Book Fair	31 HALLOWE'EN 5 & 6 Grade Party	<p style="text-align: right;">"The surest way to corrupt a youth is to instruct him to hold in higher esteem those who think alike than those who think differently." —Nietzsche</p>			

SHAW AND WASHINGTON AVENUES PARENT TEACHER ASSOCIATION

ELECTED OFFICERS 1967-1968

President	Sylvia Guttenplan	CU 5-7010
1st Vice President	Stella Schlaeger	CU 5-7588
2nd Vice President	Ida Ierardi	CU 5-6047
Secretary	Mary Horozan	CU 5-5706
Public Secretary	Marianne Wallace	Faculty
Corresponding Secretary	Marie DiGiamo	LO 1-0079
Delegates to V.S. Council	Marie Cecere	VA 5-9406
	Angela Carmosino	872-8259
	Judith Blessinger	Faculty
Presidents	Leah & Milton Gersten	VA 5-9144

COMMITTEE CHAIRMEN

Visual Art	J. Giacalone	Faculty
Visual Art	Arlene Wexner	825-0381
Visual Art	Mary Mack	Faculty
Visual Art	Mary Baier	872-8751
Visual Art	Arlene Wexner	825-0381
Visual Art	Helen Inwald	CU 5-5964
Visual Art	Lila Markowitz	285-5008
Visual Art	Angela Carmosino	872-8259
Visual Art	Ann Danyluk	VA 5-5114
Visual Art	Lenore Schiff	LO 1-9575
Visual Art	Emily Manno	CU 5-5852
Visual Art	Mary Catalfomo	VA 5-2225
Visual Art	Marie Spinelli	CU 5-9428
Visual Art	John Schiff	LO 1-9575
Visual Art	Kay Hadjiyane	CU 5-7434
Visual Art	Rita Dolan	CU 5-6008
Visual Art	Betsy Pine	CU 5-5806
Visual Art	Joyce Fisher	LO 1-9675
Visual Art	Miriam Balaban	CU 5-8191
Visual Art	Ida Ierardi	CU 5-6047
Visual Art	Leah Gersten	VA 5-9144
Visual Art	Dorothy Colletti	Faculty
Visual Art	Leah & Milton Gersten	VA 5-9144
Visual Art	Grace Federici	CU 5-7235
Visual Art	Joan Hartman	Faculty
Visual Art	Stella Schlaeger	CU 5-7588
Visual Art	Joanne Evans	5-8393
Visual Art	Milton Gersten	5-9144
Visual Art	Jackie Pena	825-0887

Fashion Show

Angela Carmosino	872-8259
Ann Danyluk	VA 5-5114
Lenore & John Schiff	LO 1-9575
Les Dimond	LO 1-7675
Marie Laudisio	CU 5-6126
Dolores Calabro	CU 5-7002
Dee Robson	825-0598
Edith Wolff	CU 5-7552
Julia Score	LO 1-0120
Norma Amitrano	825-5508
Ginnie Dimond	LO 1-7675
Donnie Gally	VA 5-6206

Youth & Recreation

Kindergarten Rep.
1st Grade Rep.
2nd Grade Rep.
3rd Grade Rep.
4th Grade Rep.
5th Grade Rep.
6th Grade Rep.

P.T.A. PROGRAM

Sept. 13	Executive Board Meeting
20	General Meeting: Meet the Faculty. Program: Anti-Smoking
27	Jelly Apple and Pretzel Sale
Oct. 3	Kindergarten & First Grade Teas
10	2nd & 3rd Grade Teas
11	Executive Board Meeting
17	4th & 5th Grade Teas
23	Children's Movie
24	6th Grade Tea
30	through Nov. 4 Book Fair
Nov. 1	Executive Board Meeting
15	"Mental Health Workshop"—afternoon
Dec. 5	Cake Sale
6	Executive Board Meeting
15	PTA Holiday Assembly for Children
Jan. 4	Executive Board Meeting—afternoon
Feb. 7	Executive Board Meeting—afternoon
14	Founder's Day Celebration at Forest Road School
March 6	Executive Board Meeting
13	General Afternoon Meeting: Election of Officers "Family Living Workshop"
20	Fashion Show
April 3	Executive Board Meeting
9	Paid-up Membership Party
May 1	Executive Board Meeting
15	General Meeting: Installation of Officers. Entertainment
June 5	Joint Board Meeting

NOVEMBER 1967

SUNDAY	MONDAY	TUESDAY	WEDNESDAY	THURSDAY	FRIDAY	SATURDAY
			1 PTA Ex. Bd. Meeting Forest, 8:30 p.m. PTA Book Fair, Shaw PTA Ex. Bd. Meeting Shaw, 8:30 p.m.	2 PTA Ex. Bd. Meeting Clear Stream, 1:15 PTA Book Fair, Shaw	3 PTA Book Fair, Shaw	4 PTA Book Fair, Shaw
5	6 PTA CAKE SALE Forest, 11 a.m.-3 p.m.	7 ELECTION DAY SCHOOL CLOSED	8	9 PTA Father-Faculty Night Clear Stream, 8 p.m.	10	11 VETERANS DAY
12	13	14 C.H.S. Board Meeting, 8 p.m.	15 Pre-School Mt., 3 p.m. Gen. Meeting, 3 p.m. Forest PTA Mental Health Wkshp, Aftern'n, Shaw	16	17 PTA Card Party Clear Stream, 8 p.m.	18
19	20 REPORT CARDS SENT OUT TODAY	21	22 SCHOOL CLOSES AT 12:00 NOON	23 THANKSGIVING RECESS	24 THANKSGIVING RECESS	25
26	27	28 Dist No. 30 Bd. of Ed. Meeting	29	30 PTA Ex. Bd. Meeting	Pupil Malapropism: The pistol of a flower is its only protection against insects.—NEA Journal	

CLEAR STREAM AVENUE PARENT TEACHER ASSOCIATION

ELECTED OFFICERS 1967-1968

<i>Presidents</i>	Marion Bourne	561-8237
	Connie Deering	CU 5-6210
<i>First Vice President</i>	Lois Barry	CU 5-8654
<i>Second Vice President</i>	Jeanette Ermiler	VA 5-6368
<i>Treasurer</i>	Dorothy Wirth	VA 5-6261
<i>Membership</i>	Muriel Watterson	825-5478
<i>Recording Secretary</i>	Rose Weltsek	LO 1-1038
<i>Corresponding Secretary</i>	Jo Heckman	LO 1-6414
<i>Delegates to V.S. Council</i>	Edith-May Yelland	Faculty
	Muriel Schult	CU 5-8631
<i>Past President</i>	Melba Williams	LO 1-9774

COMMITTEE CHAIRMEN

<i>Arts & Flyers</i>	Gladys Stankiewicz	LO 1-8498
	Helenmarie Lartigau	825-2643
<i>Audio-Visual</i>	Frank DeMarco	Faculty
<i>Budget</i>	Muriel Schult	CU 5-8631
<i>Civic Relations</i>	Jane Klasmeyer	CU 5-5811
<i>Cultural Arts</i>	Lee Cohen	CU 5-5668
<i>Decorations</i>	Louise LeJeune	Faculty
<i>Health & Mental Health</i>	Cathy Eggolt	CU 5-7873
	JOPat Minerva	VA 5-7433
<i>Historian</i>	Margie Croak	VA 5-9352
<i>Legislation</i>	Mary Zeno	285-5298
	Peggy Carlson	CU 5-8857
	Dolly Mabe	872-3007
<i>Librarian</i>	Josephine Balsano	CU 5-9700
<i>Mimeographers</i>	Rita DiStefano	VA 5-2169
	Arlene Cooper	825-7779
<i>Parent Education</i>	Hilda Flynn	VA 5-6081
<i>Parliamentarian & By-Laws</i>	Dorothea Munson	LO 1-2547
	Gert Ganzi	825-2004
<i>Pre-School</i>	Lois Barry	CU 5-8654
	Arlene Cooper	825-7779
	Marie Cusumano	VA 5-4956
<i>Program</i>	Jeanette Ermiler	VA 5-6368
<i>Publications</i>	Elaine Kirchmann	LO 1-7353
<i>Publicity</i>	Jean Saladino	LO 1-7827
<i>Public Relations</i>	Ruth Cornish	872-8491
<i>Safety</i>	Muriel Grancher	CU 5-7637
	Madelyn Weiss	825-1719
<i>Scholarship</i>	Martha Keller	VA 5-3171
<i>School Board Delegates</i>	Warren Cornish	872-8491
	Jim Williams	LO 1-9774
	Frank Acquavella	VA 5-2272
<i>Sunshine</i>	Alice Lizza	CU 5-8490
THE STREAMER	Helen Martino	CU 5-5834
	Kay Ciccone	LO 1-9207
	Doris Horowitz	825-2865
<i>Distribution</i>	Claire DiNapoli	CU 5-6275
<i>Typist</i>	Theresa Keller	CU 5-7016
<i>Ways & Means</i>	Kay Schmidt	872-8692

Ways & Means

<i>Typist</i>	Ann Planco	LO 1-2218
<i>Typist</i>	Dolores O'Leary	VA 5-5943
	Lillian Serpico	LO 1-0117
	Ann Prisco	CU 5-5744
	Gloria Corradi	CU 5-5255
	Mary Tragner	CU 5-9502
	Marian Acquavella	VA 5-2272
	Livia Darria	CU 5-6025
	Mary Reising	VA 5-5001
	Elaine Vitale	285-5894
<i>Hospitality</i>	Rose Vespucci	LO 1-2962
	Barbara McLaughlin	VA 5-6162
	Susan Schink	CU 5-5215
	Margaret McGovern	CU 5-9011
	Irene Pederson	LO 1-9823
<i>Welcoming Committee</i>	Dorothy Wirth	VA 5-6261
<i>Kindergarten Rep.</i>	Lillian Serpico	LO 1-0117
<i>1st Grade Rep.</i>	Josephine Coyle	CU 5-7731
<i>2nd Grade Rep.</i>	Ann Planco	LO 1-2218
<i>3rd Grade Rep.</i>	Pat Strobl	825-4640
<i>4th Grade Rep.</i>	Margaret Carlson	CU 5-8857
<i>5th Grade Rep.</i>	Rita DiStefano	VA 5-2169
<i>6th Grade Rep.</i>	Mary Lou Mullen	285-5253

P.T.A. PROGRAM

Sept.	7	Executive Board Meeting, 8 p.m.
	21	PTA General Meeting, 8 p.m.
Oct.	3	5th and 6th Grade Tea, 8 p.m.
	4	Executive Board Meeting, 1:15 p.m.
	10	Pre-School & Kindergarten Grade Tea, 8 p.m.
	17	1st and 2nd Grade Tea, 8 p.m.
	24	3rd and 4th Grade Tea, 8 p.m.
	31	5th and 6th Grade Hallowe'en Party (p.m.)
Nov.	2	Executive Board Meeting, 1:15 p.m.
	9	Father-Faculty Night, 8 p.m.
	17	Fund Raiser—Card Party, 8 p.m.
	30	Executive Board Meeting, 8 p.m.
Dec.	14	Holiday Assembly Program, 10:15 a.m. & 1:15 p.m.
Jan.	4	Executive Board Meeting, 1:15 p.m.
	18	P.T.A. General Meeting, 8 p.m.
Feb.	1	Executive Board Meeting, 1:15 p.m.
March	7	Executive Board Meeting, 8 p.m.
	15	Father, Son & Daughter Night, 8 p.m.
	21	P.T.A. Gen. Meeting, 8 p.m.—Mental Health Prog.
	27	Mental Health—5th Grade Girls, 3 p.m.
	28	Mental Health—6th Grade Girls with mothers, 7:30
	28	Mental Health—6th Grade Boys with fathers, 8:00
April	4	Executive Board Meeting, 8 p.m.
	25	Cake Sale
May	1	Executive Board Meeting, 1:15 p.m.
	16	P.T.A. General Meeting, 8 p.m.
	21	Teachers' Recognition Day—Luncheon
June	6	Joint Executive Board Meeting, 8 p.m.

DECEMBER 1967

DAY	MONDAY	TUESDAY	WEDNESDAY	THURSDAY	FRIDAY	SATURDAY	
					1	2	
	No ray of sunlight is ever lost, but the green which it wakes into existence needs time to sprout, and it is not always granted to the sower to live to see the harvest. —Albert Schweitzer						
3	4	5	6	7	8	9	
	V.S. Council of P.T.A. Meeting, Willow Road School	PTA CAKE SALE Shaw	PTA Exec. Bd. Meeting Shaw, 8:30 p.m.				
10	11	12	13	14	15	16	
		C.H.S. Bd. Mt., 8 p.m. Pre-School Mt., Part I Art, Miss Ritzenthaler Parents, Mrs. Keaney 2:30 p.m.		PTA Holiday Program Clear Stream	PTA Holiday Assembly Shaw		
17	18	19	20	21	22	23	
		District No. 30 Bd. of Ed. Meeting 8:15 p.m.	PTA Holiday Gift to Children Forest	SCHOOL CLOSURES AT REGULAR TIMES	CHRISTMAS RECESS	CHRISTMAS RECESS	
24	25	26	27	28	29	30	
RECESS			CHRISTMAS RECESS				

FOREST ROAD PARENT TEACHER ASSOCIATION

ELECTED OFFICERS 1967-1968

President	Marjorie Grauer	PY 1-6043
First Vice President	Eleanor Klein	PY 1-3060
Second Vice President	Gertrude Myron	PY 1-2386
Vice President	Ceil Barnett	PY 1-8114
Treasurer	Lawrence Schoen	PY 1-6227
Financial Secretary	Anita Strelisker	PY 1-7167
Corresponding Secretary	Muriel Roth	PY 1-4090
Recording Secretary	Lillian Spector	PY 1-2627
Delegate to Council	Phyllis Abelov	PY 1-7951
Past President	Arlene Glass	PY 1-8088

COMMITTEE CHAIRMEN

Budget	Anita Strelisker	PY 1-7167
Class Mother	Corky Shaw	PY 1-8307
Class Mother	Edith Morenstein	PY 1-8240
Family Living (Mental Health, Parent Ed., Excep. Chil.)	Selma Singer	PY 1-3592
Flyers	Irene Polakoff	PY 1-4098
Good Will & Hospitality	Pompi Macleod	PY 1-7072
	Beth Stern	PY 1-2585
	Ruth Weinstein	PY 1-9045
Health & Safety	Ronnie Blanck	PY 1-4642
Historian	Iris Casson	PY 1-4727
Legislation	Marge Blumenkoph	PY 1-6581
Library & Book Fair	Emma Bremen	PY 1-5070
	Stella Appenzeller	PY 1-7847
Membership	Marlyn Fogel	PY 1-4701
Mimeograph	Marcia Chaiet	PY 1-2641
Music & Art	Claire Weinberg	PY 1-3656
Parliamentarian	Lawrence Schoen	PY 1-6227
Pre-School	Sallie Newman	PY 1-6743
Publications	Beth Stern	PY 1-2585
Publicity	Carol Andiman	PY 1-4686
School & Comm. Relations	Wilma Baron	PY 1-4170
School Bd. Rep. - Elem.	Ora Haines	PY 1-6647
School Bd. Rep. - H.S.	Arlene Glass	PY 1-8088
	Ruth Weinstein	PY 1-9045
Teacher Rep.	Vivian Cafiso	PY 1-7676
Typist	Madeline Margulies	PY 1-5097
Ways & Means	Renee Pepper	PY 1-3857
	Marcia Horowitz	PY 1-3529
	Gloria Weinberger	PY 1-3182
	Edith Morenstein	1-8240
	Eleanor Haber	1-6678
	Kathleen Zarchy	PY 1-4029

P.T.A. PROGRAM

Aug 30	Executive Board Meeting, 8:30 p.m.
Sept. 6 & 7	PTA Book Cover Sale—starts at 2:45 p.m.
13	Class Mother Meeting, 8:15 p.m.
18-23	Mobile Paperback Book Fair
20	"Meet The Teacher Night," 8:15 p.m.
27	Executive Board Meeting, 8:30 p.m.
Oct. 11	Prizo Night, 8:15 p.m.
17	General Meeting Workshop, Mrs. Agree, 2:45 p.m.
	Hostesses: 5th & 6th Grade Class Mothers
27	6th Grade Hallowe'en Party
Nov. 1	Executive Board Meeting, 8:30 p.m.
6	PTA Cake Sale, 11 a.m. to 3 p.m.
15	Pre-school Meeting—"Let's Get Acquainted"—Mrs. Reinken, 3 p.m.
15	General Meeting, Dr. Waldo Phillips, 8:15 p.m.
	Hostesses: 3rd & 4th Grade Class Mothers
Dec. 12	Pre-school Meeting—"Fun With Art," Part I—Miss Ritzenthaler — Parents with Mrs. Keaney, Reading Consultant, 2:30 p.m.
20	Holiday Assembly—PTA Gift to Children
Jan. 3	Executive Board Meeting, 8:30 p.m.
10	General Meeting Workshop, 2:45 p.m.
	Hostesses: 1st & 2nd Grade Class Mothers
17	Pre-school Meeting—"Fun With Art," Part II—Miss Ritzenthaler—Parents with Mrs. Keaney, 2:30 p.m.
Feb. 7	Executive Board Meeting, 8:30 p.m.
14	Founder's Day Program, Prof. Raebeck, Forest, 8:30
20	Pre-school Meeting—"Let's Make Music," Miss Butler Parents with Mrs. Reinken, 3 p.m.
March 6	Executive Board Meeting, 8:30 p.m.
8	PTA Cake Sale, 11 a.m. to 3 p.m.
12	Pre-school Meeting—"Let's Have Fun," Mrs. Reinken, Parents with Mrs. Salerno, Sch. Nurse-Tchr., 3 p.m.
20	General Meeting, Mrs. Edith Lauten, School Psychologist, 8:15 p.m. Hostesses: Kindgtn. Class Mothers
April 3	Executive Board Meeting, 8:30 p.m.
3	Sex Hygiene Mtg., 5th Gr. Girls, Mrs. Salerno, 3 p.m.
22	Sex Hygiene Meeting, 6th Grade parents, 8:15 p.m.
23	Sex Hygiene Meeting, 6th Grade Girls, 3 p.m.
24	Sex Hygiene Mtg., 6th Grade Boys and fathers, 8:15
24	Pre-school Meeting—"Tell Me a Story," Mrs. Agree, Parents with Mrs. Pollet, Speech Teacher, 2 p.m.
26-27	PTA Book Fair
May 1	Executive Board Meeting, 8:30 p.m.
14	Teacher Recognition Day Luncheon, 11:30 a.m.
22	General Meeting, Installation of Officers, 8:15 p.m.
June 5	Joint Executive Board Meeting, 8:15 p.m.

JANUARY 1968

SUNDAY	MONDAY	TUESDAY	WEDNESDAY	THURSDAY	FRIDAY	SATURDAY
	1 NEW YEAR'S DAY SCHOOL CLOSED	2 SCHOOL REOPENS	3 PTA Exec. Bd. Meeting Forest, 1 p.m.	4 PTA Exec. Bd. Meeting Clear Stream, 1:15 & Shaw, Afternoon	5	6
7	8	9 C.H.S. Board Meeting, 8 p.m.	10 PTA General Meeting Workshop, Forest 2:45 p.m.	11	12	13
14	15	16	17 PTA Pre-School Mt., Part II—Art, Miss Ritzenthaler Parents, Mrs. Keaney 2:30 p.m.	18 PTA General Meeting Clear Stream, 8 p.m.	19	20
21	22	23 District No. 30 Bd. of Ed. Meeting 8:15 p.m.	24	25	26	27 Children's Theater Central H.S. "Young Mark Twain"
28	29	30	31	"A man given to pride is usually proud of the wrong thing."—Henry Ford "All good ends can be worked out by good"		

SCHOOL ADMINISTRATION

Paul W. Rossey, District Superintendent

Sherwood S. Quick
District Principal

SCHOOL PRINCIPALS

CLEAR STREAM AVENUE SCHOOL
Lawrence O. Lobdell

FOREST ROAD SCHOOL
Maurice E. St. Mary

SHAW AVENUE SCHOOL
John A. Busch

George W. Niederhauser, Assistant Principal

Elementary Consultant
William Van Ness

SCHOOL SECRETARIES

Mrs. Jeanne Feeney, Clear Stream Avenue
Mrs. Mary McDowell, Forest Road
Mrs. Jean Annona, Shaw Avenue

DISTRICT SECRETARIAL STAFF

Margaret Bradley Lucy Felice Helen Kuchler
Marie O'Connell Marcella Pantaleo Mary Ribando
Edythe Sanchez Caroline Young

Mrs. Georgette Wenzel, Cafeteria Manager

DISTRICT SPECIALISTS AND SPECIAL TEACHERS

Frank DeMarco, Audio-Visual Consultant
Rosalyn Kessler, Psychologist
Edith Lauten, Psychologist
Raydine Teicheira, Speech Consultant
Frances Pollet, Speech Teacher
Agnes Mabry, Reading Consultant
Dolores Stein, Foreign Language Consultant
Lawrence Cid, Mathematics Consultant
John Price, Instrumental Music Teacher
Gilbert Jacobson, Instrumental Music Teacher
Sheila Hoffman, Physical Education Teacher
Cathleen Meneilly, Special Counselor

OTHER SPECIALISTS AND SPECIAL TEACHERS

Clear Stream Avenue School

Janet Poppe, Reading Specialist
Grace Giacabone, Art
Philip Hessemer, Physical Education
Felicia Karolyi, Music
Ruth Newman, Librarian
Edna Giebel, Nurse-teacher

Forest Road School

Ada Keaney, Reading Specialist
Jean Ritzenthaler, Art
Alfred Stevens, Physical Education
Frances Butler, Music
Rose Agree, Librarian
Edna Salerno, Nurse-teacher

Shaw Avenue School

Noel Giambalvo, Special Counselor
Jeanne Colton, Reading Teacher
Louise Holbrook, Art
Linda Mazwell, Art
Joseph Reynolds, Physical Education
Joan Kurman, Physical Education
Katherine Egan, Music
Linda Brody, Music
Sylvia Berkowitz, Librarian
Dorothy McCutchan, Nurse-teacher

FEBRUARY 1968

SUNDAY	MONDAY	TUESDAY	WEDNESDAY	THURSDAY	FRIDAY	SATURDAY
				1	2	3
				PTA Exec. Bd. Meeting Cléar Stream, 1:15		
4	5	6	7	8	9	10
	V.S. PTA Council Mt., Wheeler Ave.		PTA Exec. Bd. Mtgs., Forest, 8:30 p.m. Shaw, Afternoon REPORT CARDS SENT OUT TODAY			
11	12	13	14	15	16	17
	LINCOLN'S BIRTHDAY SCHOOL CLOSED	C.H.S. Board Meeting, 8 p.m.	PTA Founders' Day Meeting, Forest 8:30 Prof. Raebeck All Schools			
18	19	20	21	22	23	24
		Pre-School Meeting "Let's Make Music" Miss Butler, Parents with Mrs. Reinken, 3 p.m.		WASHINGTON'S BIRTHDAY SCHOOL CLOSED	SCHOOL CLOSED	
25	26	27	28	29	"Flash powder makes a more brilliant light than the arc lamp, but you can- not use it to light your street corner because it doesn't last long enough.	
		District No. 30				

SCHOOL POLICIES

SCHOOL HOURS

Hours for grades 1, 2, and 3 are from 9:00 a.m. to 3:00 p.m.
 Hours for grades 4, 5, and 6 are from 8:30 a.m. to 2:45 p.m.

LUNCH

Beginning with the first day of school. Pupils go home for lunch, bring lunch from home, or buy the school lunch in the cafeteria for 25c. Monthly menus are provided so that you know what foods are served which your child does not eat, you can make other provisions for him for those days. In case a child loses his lunch money or his lunch, or loses either, we have a system to cover the emergency. The cashier in the cafeteria keeps the record of such charges and contacts the parents if a charge not be paid in a reasonable time.

ICE CREAM

Ice cream is sold daily to those pupils who wish it. It is not included in the hot lunch and costs an additional 10c.

RECESS MILK

Recess milk is available to all children beginning about the first week of the school year and is sold at a cost of 15c per week each Thursday for the following week. You will be notified as to the exact date. Money brought in late (Friday) cannot be accepted. In case of a child's absence, no refund is made for periods of less than a full week.

ABSENCES

If your child has been absent, State law requires that he bring a note from you explaining the absences and the date(s) of absence(s). The note should be presented to the nurse before coming to the classroom. Please be specific. Just saying, "he was sick" is not enough. Indicate whether it was "virus," "fever," "flu," etc. A note is required for an absence due to a religious holiday. A note is required for any tardiness, giving the reason. If your child contracts a contagious disease, such as mumps, measles, etc., please phone the school nurse so that she can notify the parents in your child's class that their children have been exposed. Be sure to keep the emergency card up to date at all times. You will know whom to call should your child become ill and need to go home.

NOON HOUR RULES

When pupils misbehave in the cafeteria, auditorium, or on the playground during the noon hour, after repeated reminders, the teachers have the authority to exclude them from staying in school for lunch for a few days, or longer, depending on the misbehavior. If you receive such a note from us, we would appreciate your cooperation. Whether or not a mother is home during the noon hour has no bearing on this exclusion.

RELEASED TIME FOR RELIGIOUS INSTRUCTION

A Release Form signed by the parent is necessary should you want your child excused from school for religious instruction. Such forms can be obtained from your church. The time provided is the last hour of school on Wednesday afternoons.

EXITS AND ENTRANCES

Your child's class is assigned a specific exit and entrance to use. You will thus know where to meet him if you come to pick him up. Parents picking up children are asked to meet them at the exit, not the classroom.

ENTRANCE TIMES

Primary grade children (Grade 1-3) are not allowed to enter the building before 8:50 a.m. and 12:50 p.m. at Shaw and Forest, and at 8:50 and 12:55 at Clear Stream, except that in inclement weather they may come into the designated area five minutes before the above times. For this reason and because there is no supervision of the playground in the morning, we suggest you arrange your child's departure from home to allow him to arrive just in time to enter the building during the proper interval. Intermediate grade children (Grades 4-6) are not allowed to enter before 8:20 a.m. The teachers assign line-up areas on the playground for the various classes after school has begun in September.

CLASS INTERRUPTIONS

No unnecessary interruptions of classes are allowed once the day's sessions have begun. When your child forgets a book, homework, sneakers, lunch money, etc., please bring these to the office. All pupils are instructed to check with the office at lunch time for such forgotten items. In the interest of the child's all-round education, we urge you not to make a practice of bringing forgotten items to school. The child should be developing his own sense of responsibility for these things.

MARCH 1968

SUNDAY	MONDAY	TUESDAY	WEDNESDAY	THURSDAY	FRIDAY	SATURDAY	
	"Great minds have purposes, others have wishes."— <i>Washington Irving</i> "Habits form character, and character destiny."— <i>Kaines</i> If you would like to build a better world, start with your own community.					1	2
3	4	5	6 PTA Exec. Bd. Meeting Forest, 8:30 p.m. Shaw, 8:30 p.m.	7 PTA Exec. Bd. Meeting Clear Stream, 8 p.m.	8 PTA CAKE SALE Forest, 11 a.m.-3 p.m.	9 Children's Theater Central H.S. "Princess and the Frog"	
10	11	12 C.H.S. Board Meeting 8 p.m. Pre-School Mt., Forest Children, Mrs. Reinken Parents, Mrs. Salerno	13 PTA General Meeting Afternoon, Shaw	14 PURIM	15 PTA Father-Son- Daughter Night Clear Stream, 8 p.m.	16	
17 NICK'S DAY	18	19	20 PTA General Meeting Forest, 8:15 p.m. Mrs. Lauten PTA Fashion Show Shaw	21 PTA General Meeting Mental Health Clear Stream, 8 p.m.	22	23	
24	25	26 Dist No. 30 Bd. of Ed. Meeting 8:15 p.m.	27 Mental Health, 5th Grade Girls Clear Stream, 8 p.m.	28 Mental Health, 6th Grade Girls, 7:30 Clear Stream, 8 p.m.	29	30	
31							

SCHOOL POLICIES

GYM SUITS AND SNEAKERS

Gym suits are required of pupils below the 4th grade, but sneakers are necessary for any pupils using the gym. Boys and girls from the 4th through 6th grades are required to wear gym suits and sneakers on the assigned gym days. The gym teachers explain this to the pupils, but many times they do not bring correct information home.

Who MUST PURCHASE A NEW SUIT should buy the same color ROYAL BLUE, bloomer type, with elastic bottoms, or ROYAL BLUE shorts with elastic insert in the cuff, and a white top. Boys should wear ROYAL BLUE shorts, with elastic top, sneakers (high top ones preferred), and white or SCHOOL "T"

IF A CHILD HAS ANOTHER COLOR, OR TYPE, HE DOES NOT NEED TO BUY A NEW ONE. The above apparel may be purchased at many local stores in Valley Stream. NO ONE IS ALLOWED ON THE GYM FLOOR WITHOUT SNEAKERS.

APPOINTMENTS WITH TEACHERS

Remember that pupils' classtime be used to the fullest advantage, request that parents do not seek conferences with teachers during school hours. If you wish a conference, please make an appointment to see the teacher after school. Teachers are available for such conferences every day except Mondays and Fridays.

BICYCLES

Bicycles are allowed at either Forest Road or Clear Stream Elementary Schools because no child lives far enough from the school to make them necessary. They are allowed at Shaw, but are restricted to pupils in grades 4, 5, and 6 who live NORTH OF CLEAR AVENUE. Bicycles used to come to the Shaw Avenue School will be assigned a number. All must have a lock and a bell for safety purposes.

GIFTS TO TEACHERS PROHIBITED

Policy of the school district which became effective January 1, 1956, is to prohibit the acceptance of gifts by faculty members on school premises, and to prohibit the solicitation of funds for personal gifts purposes, by any person, or person on the premises.

IN-DAY PROGRAM

In inclement weather, there is an in-day program of motion pictures provided for those pupils who eat in the cafeteria. Pupils who go home to lunch are not allowed to participate in this program because of space limitations, so we ask parents to return these pupils to school on such days just in time for the afternoon session—not before 12:50 p.m. for grades 1 to 3, and 12:20 p.m. for grades 4 to 6 at Shaw and Forest; and not before 12:55 for grades 1 to 3 and 12:15 for grades 4 to 6 at Clear Stream.

HOMEWORK REQUIREMENTS

Homework is required of all pupils, but it will vary from day to day. First and second grade pupils may have fifteen to twenty minutes of homework per day, while third and fourth grade pupils are likely to have thirty to forty minutes. Fifth and sixth graders are expected to devote as much as an hour to homework, but again this may not be every day—it will depend on the pupil and his needs.

LOST AND FOUND

Unmarked articles lost by pupils are placed in the Lost-and-Found, which is in the Nurse's Office. Such articles, if not claimed at the end of the school year, are given to a charitable organization. However, any articles bearing a child's name is returned directly to him. Please place your child's name on all his belongings.

STAYING AFTER SCHOOL

To eliminate any confusion or problems, the school may have your child every day for an additional half hour. During this half hour beyond the regular school day, the teacher may schedule your child for special help or keep him for any of several reasons. We ask that you keep this in mind and not schedule dental appointments, dancing lessons, etc. until after that interval. Teachers are also available to parents during the half hour after school, except on Monday and Friday, for conferences. Appointments are not necessary, but it is to your advantage to make one, so that you can be sure of the teacher's availability.

ASSEMBLIES

When your child's class puts on the assembly, we welcome your attendance, but we do ask you not to bring pre-school children. As much as we realize that it is a thrill for them to see big brother perform, they are often distracting to all concerned.

APRIL 1968

DAY	MONDAY	TUESDAY	WEDNESDAY	THURSDAY	FRIDAY	SATURDAY
	1 V.S. PTA Council Mt., Shaw	2	3 PTA Ex. Bd. Mt., Forest, 8:30 Sex Hygiene Mt., 5th Gr. Girls, Mrs. Salerno Forest, 3 p.m. PTA Exec. Bd. Meeting Shaw, 8:30 p.m.	4 PTA Ex. Bd. Meeting Clear Stream, 8 p.m.	5	6
7	8 REPORT CARDS SENT OUT TODAY	9 C.H.S. Board Meeting, 8 p.m. PTA Paid-Up Membership Party Shaw	10 SCHOOL CLOSSES AT REGULAR TIMES	11 EASTER RECESS	12 EASTER RECESS	13 EASTER RECESS PASSOVER
14 RECESS	15 EASTER RECESS	16 EASTER RECESS	17 EASTER RECESS	18 EASTER RECESS	19 EASTER RECESS	20 EASTER RECESS
21	22 SCHOOL REOPENS Sex Hygiene, 6th Gr. Parents, Forest, 8:15	23 Dist. No. 30 Bd. of Ed. Meeting, 8:15 p.m. 6th Grade Girls Sex Hygiene Meeting Forest, 3 p.m.	24 6th Gr. Boys & Fathers Sex. Hyg. Mt., Forest 8:15; Pre-Sch. Mt., w. Mrs. Agree; Parents w. Mrs. Pollet, For., 2:00	25 PTA CAKE SALE Clear Stream	26 PTA BOOK FAIR, For. Registration for Next Year's Kindergarten, Each Sch., 9-11 a.m.	27 PTA BOOK FAIR, For. Registration for School Voting, 7 a.m. to 12 Noon
28	29	30	<p>"Not enjoyment, and not sorrow Is our destined end or way; But to act, that each tomorrow Finds us farther than today."</p>			

THE SCHOOL BUDGET

With many school budgets going down to defeat this past school year, it is our feeling that the taxpayers should be more informed in regard to this part of the school program.

Like our own personal budgets, school budgets have been greatly affected by the increased costs in all areas. Costs of paper, pencils, textbooks, fuel oil, repairs and maintenance of buildings have all risen, to mention only a few items. The largest increase in school budgets has been employee salaries for the same reasons that salaries in business have risen. In addition, new mandates from the State of New York have required boards of education to pay more and more of the costs of teacher retirement and other fringe benefits without monetary help from the State. Your Board of Education has nothing to say about such increases; they are required by law to comply. This part of the school budget represents from 80 to 85% of the budget.

The other 15 to 20% of the budget covers items such as cafeteria, summer recreation programs, interscholastic sports, new equipment, new textbooks, renovations to the buildings, extra-curricular activities, use of the building by community

groups, and the like. These are the items which are usually eliminated when a district must go on an austerity budget. They are also some of the most important as was shown by a study made by the Metropolitan School Study Council of a few years ago. This study showed that where a school district spent adequate money on these parts of the budget, there was a positive correlation between amount of money spent and the excellence of the school program.

For the resident who really wishes to have something to say about the school budget, we advise you to keep aware of what the New York State legislature considers at each legislative session when bills are introduced which concern education. Your Parent-Teacher Associations keep well abreast of these matters and can inform you. After you have gained the facts, then make your feelings known to your representatives to help guide how they vote on such matters. Your own Board of Education begins formulating the budget each January. Attendance at its regular monthly meetings will help keep you informed. Look for the meeting dates in this calendar. All meetings are held at the Shaw Avenue School and begin at 8:15 p.m.

MAY 1968

SUNDAY	MONDAY	TUESDAY	WEDNESDAY	THURSDAY	FRIDAY	SATURDAY
			1 PTA Exec. Bd. Mtgs. Forest, 8:30; Clear Stream, 1:15; Shaw, 8:30 p.m.—Reg. on Sch. Voting, 4-10 p.m.	2	3	4
5	6	7	8 VOTING ON SCHOOL BUDGET	9	10	11
12 MOTHER'S DAY	13	14 C.H.S. Board Meeting, 8 p.m. Teacher Recognition Day Luncheon Forest 11:30 a.m.	15 PTA Gen. Meeting Shaw, 8:30 p.m.	16 ART EXHIBIT Forest, 7:30-9 p.m. PTA Gen. Meeting Clear Stream, 8 p.m.	17	18
19	20	21 ART EXHIBIT Cl. Stream, 7:30-9 p.m. Teach. Recognition Day Luncheons Cl. Stream & Shaw	22 PTA General Meeting Forest, 8:15 p.m.	23 ART EXHIBIT Shaw, 7:30-9 p.m.	24	25
26	27 Registration for Next Year's Kindergarten, Each Sch., 9-11 a.m.	28 Dist No. 30 Bd. of Ed. Meeting 8:15 p.m.	29	30 MEMORIAL DAY SCHOOL CLOSED	31 SCHOOL CLOSED	

STARS TO STEER BY
It's nice to be important, but more important to be nice. It's not where you live, but how you live. One is not likely to get lost on a straight road."
—Speaking to all youth

HISTORY OF UNION FREE SCHOOL DISTRICT THIRTY

As is typical of Long Island School districts, District Thirty began as a small rural school and since has blossomed into what it is today. The records are not available for all its years of existence but the facts and figures we do have are quite revealing.

For instance, in 1945 Clear Stream Avenue was the only school building and it had an enrolment of 525 pupils. Shaw Avenue opened in 1950, at which time the school population had increased to 1210 pupils. With the continued influx of new residents, it was necessary to open Forest Road in 1953 when the district enrolment had risen to 2207.

Each year, from 1953 on, there were increases in the number of pupils until the top figure of 2685 was reached in 1957-58. Since that year there has been a gradual decline in enrolment so that the expected enrolment for 1967-68 will be about 2000.

Along with the increases in pupil numbers came increases in the number of teachers and other employees and correspondingly, larger budgets and higher taxes. In 1948, there were 29 people on the professional staff. This rose to a top of 114 in 1957-58. The tax rate in 1948 was \$1.70 and has risen each year to the present estimated \$7.29 for 1967-68.

Of interest is, that from the days when it was necessary to have some classes on split-sessions (1950-58) and class

sizes of 34 pupils per class, we now have all groups on full-time and a class size of about 24 pupils per class.

The population of the district was 13,075 in 1953 and rose to 17,596 by 1962. Since that year, it has remained fairly stable and in 1966 it was 17,462. The history of other communities, similar to Valley Stream, shows that, after a decrease in school population such as we have had in District Thirty, the older residents move, new, younger couples take over the homes and begin to raise their families, and the school population begins to rise again. There is no guarantee that this will happen here but this is what has transpired in other areas.

The Board member with the longest service is Dr. Robert Bell, who has served continuously since 1949, a total of 18 years. Included in those years are six terms as President of the Board of Education, the present position which Dr. Bell holds on the Board. Added to these years of service to the district is Dr. Bell's recent election as a trustee to the new Board of Cooperative Services for Nassau County.

Mrs. Elinor McAuliffe holds the distinction of being the only woman to have served as a trustee of the Board of Education in District Thirty and has served since 1958, a total of 9 years. Two of those years were as the President of the Board. She also has been one of the district's representatives to the Central High School Board and served as president of that Board in 1965-66.

JUNE 1968

SUNDAY	MONDAY	TUESDAY	WEDNESDAY	THURSDAY	FRIDAY	SATURDAY
						1
2	3	4	5 PTA Joint Bd. Mtg. Forest, 8:15 p.m. & Shaw, 8:30 p.m.	6 PTA Joint Bd. Mtg. Clear Stream, 8 p.m.	7	8
9	10 V.S. PTA Council Mt., South High	11 C.H.S. Board Meeting, 8 p.m.	12	13	14 FLAG DAY	15
16 SUNDAY	17	18	19 GRADUATION	20	21 LAST DAY OF SCHOOL	22
23	24	25	26	27	28	29
30	ANNUAL SCHOOL CENSUS BEGINS	Dist No. 30 Bd. of Ed. Meeting 8:15 p.m.				

Intelligence builds a dinosaur's skeleton from a few bones; but we must beware for intelligence also built Piltdown man, a forgery, from spurious fragments. In other words, intelligence is not in itself right and it is capable of breathtaking forgery, magnificent lies, prodigies of evil doing. Yet it is also the instrument man must mainly use to better himself."—John Hersey

**UNION FREE SCHOOL DISTRICT No. 30 AND
CENTRAL HIGH SCHOOL DISTRICT No. 1,
VALLEY STREAM, NEW YORK**

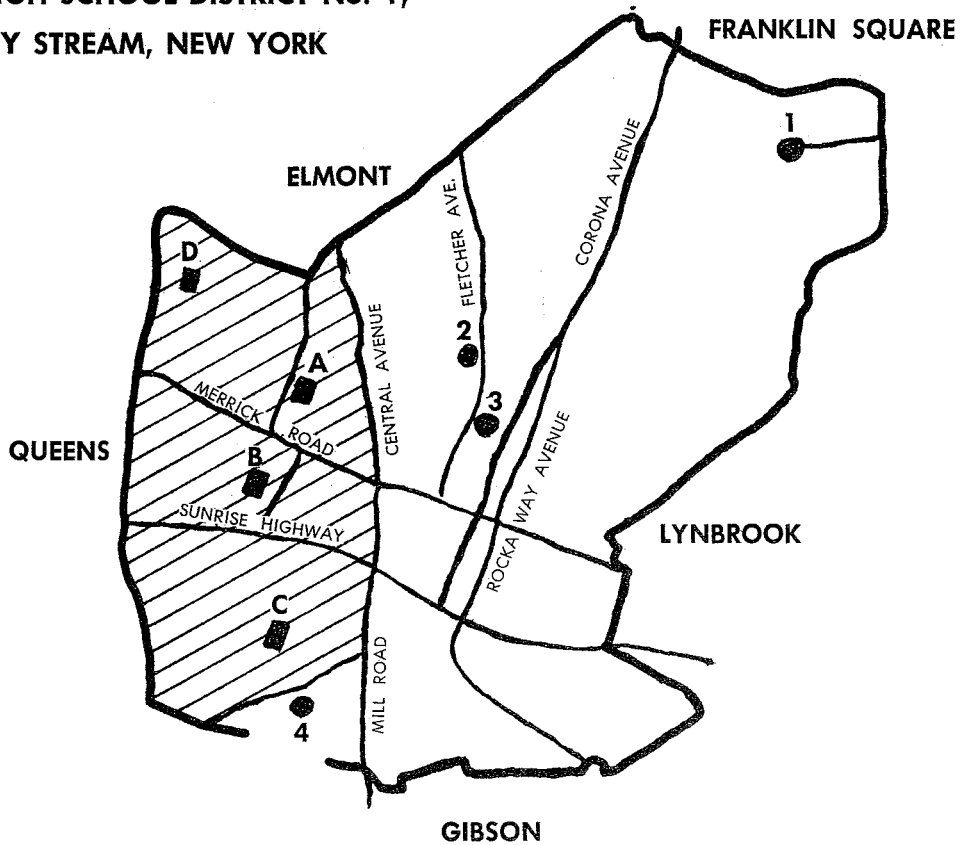

DISTRICT No. 30 SCHOOLS

- Shaw Avenue A
- Clear Stream Avenue B
- Forest Road C
- Washington Avenue D

Shaded Area — District 30

HIGH SCHOOLS

- North High 1
- Memorial Junior 2
- Central High 3
- South High 4

JULY 1968

SUNDAY	MONDAY	TUESDAY	WEDNESDAY	THURSDAY	FRIDAY	SATURDAY
	1 SUMMER RECREATION PROGRAM BEGINS	2 School Board Reorganization Mtg. District 30	3	4 INDEPENDENCE DAY	5	6
7	8	9 C.H.S. Board Meeting, 8 p.m.	10	11	12	13
14	15	16	17	18	19	20
21	22	23 Dist No. 30 Bd. of Ed. Meeting 8:15 p.m.	24	25	26	27
28	29	30	31	"There are two kinds of people in the world—those who divide the world into two kinds of people, and those who don't."—Irwin Edman		

CLEAR STREAM AVENUE SCHOOL

CLASS MOTHER LIST

Room	Class Mother	Tel. Number	Teacher
30)	Mrs. Dippolito	285-5248	Miss Schep
30)	Mrs. Wheeler	285-9645	Miss Schep
:00)	Mrs. Inzone	CU 5-6706	Miss Eden
:00)	Mrs. Reig	CU 5-9263	Miss Eden
30)	Mrs. Grassiano	CU 5-7706	Miss Eden
30)	Mrs. Prisco	CU 5-5744	Miss Eden
B	Pauline Farro	VA 5-2575	Mrs. Schaaf
B	Dolores O'Leary	VA 5-5943	Mrs. Schaaf
7	Carroll Schmidt	825-3701	Mrs. Williams
7	Marie Cusumano	VA 5-4956	Mrs. Williams
8	Muriel Watterson	825-5478	Mrs. Koubek
8	Hilda Flynn	VA 5-6081	Mrs. Koubek
2	Mary Tragner	CU 5-9502	Mrs. Guberman
2	Frances Battista	CU 5-6484	Mrs. Guberman
5	Gloria Corradi	CU 5-5255	Mrs. Galati
5	Margie McGovern	CU 5-9011	Mrs. Galati
6	Gloria Garguilo	825-4074	Miss Patterson
6	Marion Maggadino	561-2141	Miss Patterson
1	Madelyn Weiss	825-1719	Miss Firpo
1	Lora Ross	825-8402	Miss Firpo
4	Irene Kielawa	LO 1-1075	Miss LeJeune
4	Kay Schmidt	872-8692	Miss LeJeune
25	Gladys Stankiewicz	LO 1-8498	Miss Yelland
25	JOPat Minerva	VA 5-7433	Miss Yelland
3	Evelyn Pearlman	CU 5-5723	Miss Tracy
3	Rose Paladino	CU 5-8405	Miss Tracy
23	Mary Maritato	LO 1-2779	Miss Galbraith
23	Marie Bevilacqua	872-8968	Miss Galbraith
27	Rose Weltzek	LO 1-1038	Miss Donahue
27	Ruth Kane	LO 1-0865	Miss Donahue
26	Doris Moser	VA 5-1596	Mrs. McCloskey
26	Jennie Tretola	LO 1-2527	Mrs. McCloskey
28	Marilyn Lombardo	LO 1-2931	Mrs. Wicht
28	Joy Rocconva	285-8860	Mrs. Wicht
21	Jane Klasmeyer	CU 5-5811	Miss Pincus
21	Ann Snider	CU 5-7302	Miss Pincus
22	Rae Capp	CU 5-7464	Mr. Cooper
22	Muriel Schult	CU 5-8631	Mr. Cooper
24	Miriam Cohen	825-9330	Miss Melzer
24	Eleanor Lacerra	CU 5-8211	Miss Melzer

FOREST ROAD SCHOOL

CLASS MOTHER LIST

Class Mother Chairmen
Corky Shaw, PY 1-8807 and Edith Morenstein, PY 1-8240

Grade	Room	Class Mother	Tel. Number	Teacher
K	AM	201 Diane Kahn	PY 1-4756	Mrs. Reinken
*K	AM	201 Marcia Chaiet	PY 1-2641	Mrs. Reinken
K	PM	201 Bernice Eisenberg	PY 1-6792	Mrs. Reinken
K	PM	201 Gloria Weinberger	PY 1-3182	Mrs. Reinken
*1		203 Julia Fisher	PY 1-5574	Miss Cafiso
1		203 Nina Weitzner	PY 1-9615	Miss Cafiso
1		204 Marcia Goldman	PY 1-8929	Mrs. Deitrich
1		204 Elaine Lieberthal	PY 1-5098	Mrs. Deitrich
*2		205 Rhoda Kagan	PY 1-9809	Miss Perrich
2		205 Marlene Schoen	PY 1-6227	Miss Perrich
2		206 Ruth Bazerman	PY 1-3312	Miss Post
2		206 Sylvia Gleicher	PY 1-8174	Miss Post
*3		207 Pearl Lustbader	PY 1-9854	Mrs. Cummings
3		207 Pearl Kaufman	PY 1-9565	Mrs. Cummings
3		208 Lynn Kimelman	PY 1-5356	Miss Duck
3		208 Eileen Silver	PY 1-2060	Miss Duck
3		209 Doty Marks	PY 1-9504	Miss Clarke
3		209 Louise Epstein	PY 1-3959	Miss Clarke
4		210 Ronnie Blanck	PY 1-4642	Miss Bendin
4		210 Emma Breman	PY 1-5070	Miss Bendin
*4		211 Pompi Macleod	PY 1-7072	Miss Nancken
4		211 Lillian Rosner	PY 1-6318	Miss Nancken
5		214 Caryl Rothschild	PY 1-6674	Mr. Clavering
5		214 Harriet Kaye	PY 1-8403	Mr. Clavering
*5		215 Charlotte Hellreich	PY 1-4093	Mrs. Parker
5		215 Fran Pattarini	PY 1-5099	Mrs. Parker
5		216 Terry Dolgov	PY 1-5670	Miss Ackerman
5		216 Nan Cahn	PY 1-9219	Miss Ackerman
6		217 Sue Cohen	PY 1-9148	Mrs. Kalsmith
6		217 Rita Renko	PY 1-3477	Mrs. Kalsmith
6		217 Marge Blumenkoph	PY 1-6581	Mrs. Kalsmith
6		218 Irene Haimes	PY 1-9314	Mrs. Melnick
6		218 Phyllis Abelow	PY 1-7951	Mrs. Melnick
*6		218 Eleanor Haber	PY 1-6678	Mrs. Melnick
*6		218 Edith Morenstein	PY 1-8240	Mrs. Melnick
6		220 Bobbie Ostrow	PY 1-3616	Mr. Kaufmann
6		220 Anne Portnoy	PY 1-6490	Mr. Kaufmann
6		220 Gloria Rosenthal	PY 1-4856	Mr. Kaufmann

*Grade Coordinator

AUGUST 1968

DAY	MONDAY	TUESDAY	WEDNESDAY	THURSDAY	FRIDAY	SATURDAY
				1	2	3
	4	5	6	7	8	10
	11	12	13	14	15	17
			C.H.S. Board Meeting, 8 p.m.			
	18	19	20	21	22	24
	25	26	27	28	29	31
			District No. 30 Bd. of Ed. Meeting		30	

The prime reason that nations and cultures have died is that people become soft and lazy. They have quit work when they reached top of the heap. They have rested on their laurels."

Lt. Gen. James H. Doolittle

SUMMER RECREATION
PROGRAM ENDS

SHAW AND WASHINGTON AVENUE SCHOOLS

CLASS MOTHER LIST

Grade Representative Coordinator Lenore Schiff, LO 1-9575

Gr.	Room	Class Mother	Tel. Number	Teacher
Third Grade				
AM		Mrs. F. Calabro	CU 5-7002	Mrs. M. Laudisio, CU 5-6126
PM		Mrs. F. Ging	CU 5-6072	Mrs. Hartman
PM		Mrs. S. Kagan	VA 5-1659	Miss Schep
AM		Mrs. J. Kelly	825-0113	Miss Blessinger
PM		Mrs. G. Schlaeger	CU 5-7588	Miss Blessinger
Fourth Grade				
		Mrs. M. Horozan	CU 5-5706	Mrs. J. Score, LO 1-0120
4	108	Mrs. Capone	CU 5-6095	Mrs. Benedetto
4	109	Mrs. A. Carmosino	872-8259	Miss Mack
4	110	Mrs. M. Drayer	CU 5-6118	Mr. Riccobono
4	111	Mrs. E. Slonim	CU 5-9717	Mrs. Barnaby
4	112			Mrs. Pokorny
Fifth Grade				
		Mrs. M. Balaban	CU 5-8191	Mrs. N. Amitrano, 825-5508
5	114	Mrs. J. DeMarco	VA 5-8587	Mrs. Wasserman
5	116	Mrs. E. Drucker	825-9677	Miss Schwartz
5	117	Mrs. R. Montalbano	825-0996	Mrs. Kaplan
5	118	Mrs. M. Milone	825-7165	Mrs. Hamcke
5	122			Miss Murray
Sixth Grade				
		Mrs. J. Posche	VA 5-2742	Mrs. G. Dimond, LO 1-7675
6	121	Mrs. O. Ferraro	872-8348	Mrs. D. Gally, VA 5-6206
6	123	Mrs. M. Firrello	LO 1-1185	Mr. Sortino
6	124	Mrs. L. Feldman	CU 5-7833	Miss Lanell
6	125	Mrs. L. Genova	825-7894	Mrs. Sherman
6	127			Mrs. Rosche
Special		Mrs. A. Cooper	825-7779	Mr. Giacalone
Cl. 131				Miss Croley

SCHOOL TELEPHONE DIRECTORY

OFFICE: SHAW AVENUE SCHOOL		Shaw Avenue School	
Principal	VA 5-9131	Principal's Office	VA 5-9131
Nurse's Office	VA 5-9131	Nurse's Office	VA 5-9131
Media Manager	VA 5-9131		
Stream Avenue School		Washington Avenue School	
Office	VA 5-3044	Office	VA 5-9131
Office	VA 5-3044	Special Services	
		Elementary Consultant	VA 5-9131
		Guidance Consultant	VA 5-9131
		Psychologist	VA 5-9131
		Speech Consultant	VA 5-9131
		Reading Consultant	VA 5-9131
		Mathematics Consultant	VA 5-9131
		Audio-Visual Consultant	LO 1-1186

INDEX

Board of Education and School Calendar see October
 Shaw and Washington Avenue PTA see November
 Clear Stream PTA see December
 Forest Road PTA see January
 Administration and Special Services see February
 School Policies see March and April
 The School Budget see May
 The History of the District see June
 Map of the District see July
 Clear Stream and Forest Class Mothers see August
 Shaw and Washington Class Mothers see facing page

CENTRAL HIGH SCHOOL DISTRICT NO. 1
 Telephone Number: VA 5-8642
 Use this number for all high school buildings, offices and personnel

NOTES

FOR 1967-1968

Calendar

SCHOOL ACTIVITIES

UNION FREE SCHOOL DISTRICT THIRTY
VALLEY STREAM, NEW YORK

UNION FREE SCHOOL DISTRICT THIRTY
VALLEY STREAM, NEW YORK

30

SCHOOL ACTIVITIES

Calendar

FOR 1968 - 1969

PUBLISHED BY THE BOARD OF EDUCATION AND PARENT-TEACHER ASSOCIATIONS

TELEPHONE DIRECTORY

INDEX

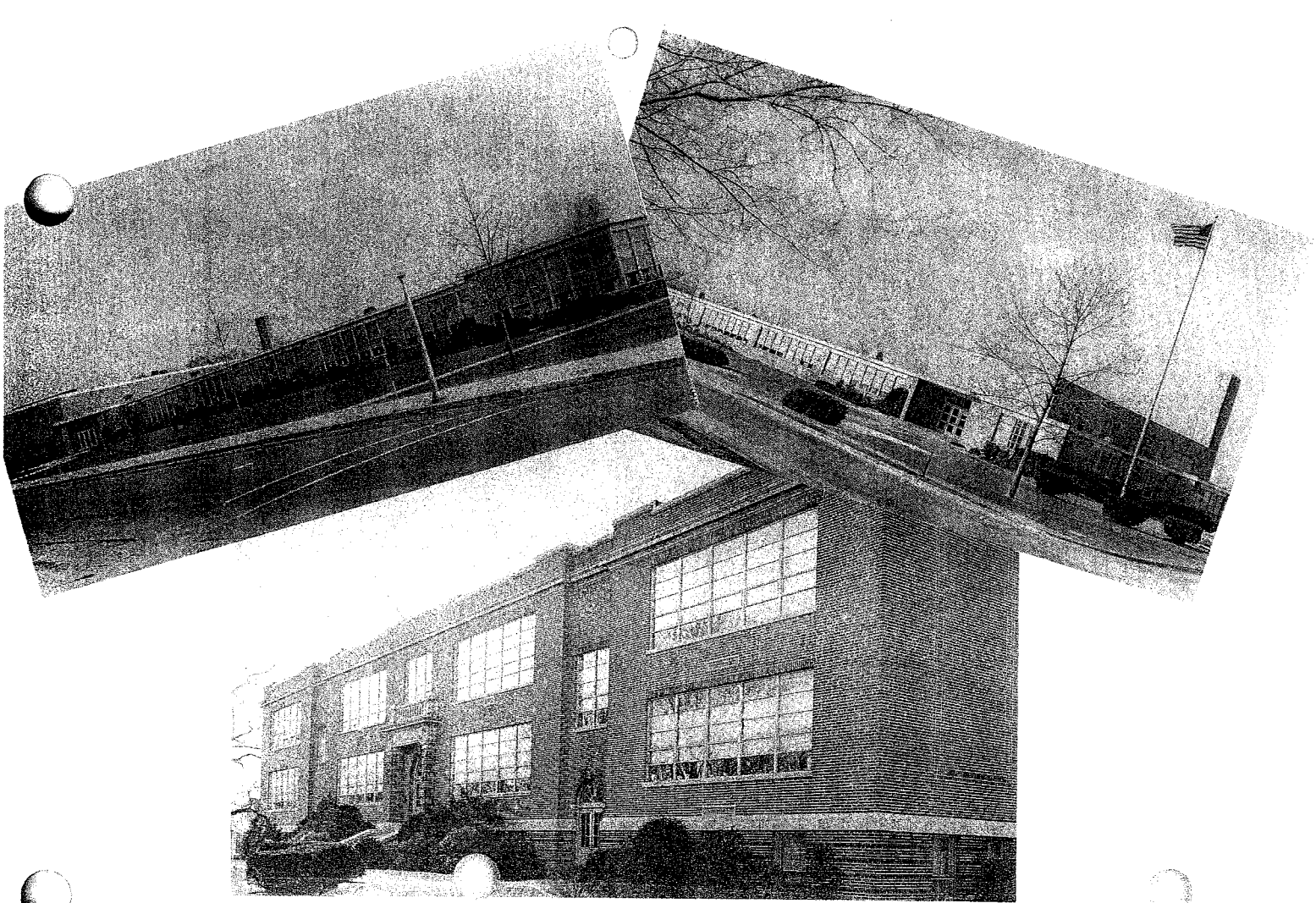

SEPTEMBER 1968

SUNDAY	MONDAY	TUESDAY	WEDNESDAY	THURSDAY	FRIDAY	SATURDAY
1	2 LABOR DAY	3 FACULTY MEETING	4 SCHOOL OPENS PTA Book Cover Sale Forest, 2:45 p.m.	5 PTA Book Cover Sale Forest, 2:45 p.m. PTA Exec. Bd. Mtg., Clear Stream, 8 p.m.	6	7
8	9	10 C.H.S. Board Meeting, 8 p.m.	11 Class Mother Meeting, Forest, 8:15 p.m. PTA Exec. Bd. Mtg., Shaw, 8:30 p.m.	12	13	14
15	16	17 Dist. No. 30 Bd. of Ed. Meeting, 8:15 p.m.	18 PTA Gen. Meeting, "Meet The Teacher Night," Forest, 8:15 Parent's Night, Wash. Ave., 8 p.m.	19 PTA Gen. Meeting, Clear Stream, 8 p.m.	20	21
22	23 ROSH HASHANAH SCHOOL CLOSED	24 ROSH HASHANAH SCHOOL CLOSED	25 Parent's Night, Shaw Avenue, K-3-8 p.m. 4-6-9 p.m.	26	27	28
29	30 V.S. PTA Council Mt., Brooklyn Avenue	<p>SEE HOW THEY GROW! Ages 2½ years to four.</p> <p><i>Physical Development</i>—Full set of temporary teeth by three years, change in sleep pattern—12 hours needed at night but still needs rest period.</p> <p><i>Characteristic Behavior</i>—Great curiosity. Asks countless questions.</p> <p>SPECIAL NEEDS—Simple, clear routines. Limited choices. Needs to play with other children. Security of parental love.</p>				

BOARD OF EDUCATION



Standing (left to right): Eleanor Zeller, Board Clerk; Sherwood Quick, District Principal; George Adams, School Attorney; George Levine*; James R. Smith; Eleanor Berger, Board Treasurer. Seated: Elinor McAuliffe*, Vice-president; Robert Bell; Nathaniel Altschul*, President.

*Also serves on High School Board.

SCHOOL CALENDAR, 1968-1969

<table border="0" style="width: 100%;"> <tr> <td>meetings (School District conference)</td> <td>Tues. Sept. 3</td> </tr> <tr> <td>tion</td> <td>Tues. Sept. 3</td> </tr> <tr> <td>y of School</td> <td>Wed. Sept. 4</td> </tr> <tr> <td>shanah</td> <td>Mon. & Tues. Sept. 23 & 24</td> </tr> <tr> <td>ppur</td> <td>Wed. Oct. 2</td> </tr> <tr> <td>ference (N.Y.S. Teachers' Assn.)</td> <td>Mon. Oct. 21</td> </tr> <tr> <td>' Day</td> <td>Mon. Nov. 11</td> </tr> <tr> <td>iving Recess</td> <td>Schools close at end of morning session</td> </tr> <tr> <td></td> <td>Nov. 27</td> </tr> <tr> <td></td> <td>School reopens</td> </tr> <tr> <td></td> <td>Dec. 2</td> </tr> </table>	meetings (School District conference)	Tues. Sept. 3	tion	Tues. Sept. 3	y of School	Wed. Sept. 4	shanah	Mon. & Tues. Sept. 23 & 24	ppur	Wed. Oct. 2	ference (N.Y.S. Teachers' Assn.)	Mon. Oct. 21	' Day	Mon. Nov. 11	iving Recess	Schools close at end of morning session		Nov. 27		School reopens		Dec. 2	<table border="0" style="width: 100%;"> <tr> <td>Christmas Recess</td> <td>School closes at regular time</td> <td>Fri. Dec. 20</td> </tr> <tr> <td></td> <td>School reopens</td> <td>Thurs. Jan. 2</td> </tr> <tr> <td>Lincoln's Birthday & Winter Recess</td> <td>Wed., Thur. & Fri. Feb. 12, 13 & 14</td> <td></td> </tr> <tr> <td>Easter Recess</td> <td>School closes at regular time</td> <td>Wed. April 2</td> </tr> <tr> <td></td> <td>School reopens</td> <td>Mon. April 14</td> </tr> <tr> <td>Memorial Day</td> <td>School closes for pupils</td> <td>Fri. May 30</td> </tr> <tr> <td></td> <td>School closes for teachers</td> <td>June 20</td> </tr> <tr> <td></td> <td></td> <td>Fri. June 20</td> </tr> </table>	Christmas Recess	School closes at regular time	Fri. Dec. 20		School reopens	Thurs. Jan. 2	Lincoln's Birthday & Winter Recess	Wed., Thur. & Fri. Feb. 12, 13 & 14		Easter Recess	School closes at regular time	Wed. April 2		School reopens	Mon. April 14	Memorial Day	School closes for pupils	Fri. May 30		School closes for teachers	June 20			Fri. June 20
meetings (School District conference)	Tues. Sept. 3																																														
tion	Tues. Sept. 3																																														
y of School	Wed. Sept. 4																																														
shanah	Mon. & Tues. Sept. 23 & 24																																														
ppur	Wed. Oct. 2																																														
ference (N.Y.S. Teachers' Assn.)	Mon. Oct. 21																																														
' Day	Mon. Nov. 11																																														
iving Recess	Schools close at end of morning session																																														
	Nov. 27																																														
	School reopens																																														
	Dec. 2																																														
Christmas Recess	School closes at regular time	Fri. Dec. 20																																													
	School reopens	Thurs. Jan. 2																																													
Lincoln's Birthday & Winter Recess	Wed., Thur. & Fri. Feb. 12, 13 & 14																																														
Easter Recess	School closes at regular time	Wed. April 2																																													
	School reopens	Mon. April 14																																													
Memorial Day	School closes for pupils	Fri. May 30																																													
	School closes for teachers	June 20																																													
		Fri. June 20																																													

O C T O B E R 1 9 6 8

DAY	MONDAY	TUESDAY	WEDNESDAY	THURSDAY	FRIDAY	SATURDAY
		1	2	3	4	5
	Development — Apt to be far-advanced general motor control, small but fully developed. Not ready for st. Attention span short.		YOM KIPPUR SCHOOL CLOSED	PTA Exec. Bd. Mtg., Clear Stream, 1:15 p.m.		
6	7	8	9	10	11	12
	SUKKOTH	SUKKOTH C.H.S. Board Meeting, 8 p.m.	PTA Exec. Bd. Mtg., Forest, 8:15 p.m.			COLUMBUS DAY
13	14	15	16	17	18	19
	Last Day of SUKKOTH	Rejoicing of the Law	PTA Gen. Meeting, Shaw, 8:15 p.m.	PTA Workshop Clear Stream 1:30 p.m.		
20	21	22	23	24	25	26
	Teachers Conference SCHOOL CLOSED Children's Movies, Clear Stream	Dist. No. 30 Bd. of Ed. Meeting, 8:15 p.m.	PTA Gen. Meeting, Forest, 8:15 p.m. PTA Jelly Apple & Pretzel Sale, Shaw			
27	28	29	30	31	AGE FIVE: <i>Characteristic Behavior</i> — Home-centered-noisy and vigorous. Uses language well. SPECIAL NEEDS — Chance to do things for himself. Training in group effort, sharing and in good work habits.	
			HALLOWE'EN 6th Gr. Hallowe'en Party, Forest	5th & 6th Grade Party, Clear Stream		

SHAW AND WASHINGTON AVENUES PARENT TEACHER ASSOCIATION

ELECTED OFFICERS 1968-1969

President	Stella Schlaeger	CU 5-7588
Vice President	Ida Ierardi	CU 5-6047
Assistant Vice President	Angela Carmosino	872-8259
Secretary	Emily Manno	CU 5-5852
Assistant Secretary	Judith Blessinger	Faculty
Publicity Secretary	Marie DiGiamo	LO 1-0079
Records Secretary	Marie Cecere	VA 5-9406
Assistant to Council	Betsy Pine	CU 5-5806
	Elvira Bellini	Faculty
	Sylvia Guttenplan	CU 5-7010

School Board Rep.	George Schlaeger	CU 5-7588
Vision Screening	Lila Markowitz	285-5008
Ways and Means	Angela Carmosino	872-8259
Kindergarten Rep.	Lois Plawsky	VA 5-4061
1st Grade Rep.	Elaine Kagan	VA 5-1659
2nd Grade Rep.	Maureen Pascale	825-0303
3rd Grade Rep.	Dee Robson	825-0598
4th Grade Rep.	Sylvia Guttenplan	CU 5-7010
5th Grade Rep.	Julia Score	LO 1-0120
6th Grade Rep.	Norma Amitrano	825-5508

COMMITTEE CHAIRMEN

Visual Arts	John Giacalone	Faculty
Arts	Sylvia Guttenplan	CU 5-7010
Arts	Mary Mack	Faculty
Arts	Jean Davis	872-3938
Arts	Arlene Wexner	825-0381
Arts	Helen Inwald	CU 5-5964
Arts	Lila Markowitz	285-5008
Arts	Angela Carmosino	872-8259
Arts	Lillian Fayet	561-6973
Arts	Lenore Schiff	LO 1-9575
Arts	Fran Dickinson	CU 5-9496
Arts	Dee Robson	825-0598
Arts	Mary Catalfomo	VA 5-2225
Arts	Marie Spinelli	CU 5-9428
Arts	John Schiff	LO 1-9575
Arts	Kay Hadjiyane	CU 5-7434
Arts	Rita Dolan	CU 5-6008
Arts	Sylvia Guttenplan	CU 5-7010
Arts	Miriam Balaban	CU 5-8191
Arts	Ida Ierardi	CU 5-6047
Arts	Mary Horozan	CU 5-5706
Arts	Dorothy Colletti	Faculty
Arts	Sylvia Guttenplan	CU 5-7010
Arts	Vita Capossela	285-6160
Arts	Joan Hartman	Faculty
Arts	Arlene Wexner	825-0381
Arts	Lillian Rukasin	285-7679

P.T.A. PROGRAM

Sept. 11	Board Meeting — 8:30 p.m.
18	Parents' Night — Washington Ave. — 8:00 p.m.
25	Parents' Night — Shaw Ave. — K to 3: 8 p.m.; 4 to 6: 9 p.m.
Oct. 9	Board Meeting — 8:30 p.m.
16	General Meeting — 8:15 p.m.
23	Jelly Apple and Pretzel Sale — 2:30 to 3:30 p.m.
Nov. 6	Board Meeting — 8:30 p.m.
16	Movie
20	General Meeting — Afternoon — (Parent Education)
Dec. 4	Cake Sale — 10:00 a.m. to 3:30 p.m.
4	Board Meeting — 8:30 p.m.
5	Pre-School Meeting — 3:00 to 3:30 p.m.
13	P.T.A. Holiday Assembly for Children
Jan. 7	Pre-School Meeting — 3:00 to 3:30 p.m.
8	Board Meeting — Afternoon
Feb. 5	Board Meeting — 8:30 p.m.
6	Founders' Meeting — Clear Stream Avenue School
March 4	Pre-School Meeting — 3:00 to 3:45 p.m.
5	Board Meeting — 8:30 p.m.
12	Fashion Show
19	General Meeting — Afternoon — (Mental Health)
April 16	Board Meeting — 8:30 p.m.
21-25	Book Mobile — (All Week)
May 7	Board Meeting — 8:30 p.m.
13	Teacher Recognition Day — Luncheon
21	General Meeting — 8:15 p.m. — (Installation Officers)
June 11	Joint Board Meeting — 8:30 p.m.

NOVEMBER 1968

DAY	MONDAY	TUESDAY	WEDNESDAY	THURSDAY	FRIDAY	SATURDAY	
	AGE SIX: Physical Development —Growth is slowed, lengthening out. 11 to 12 hours sleep needed. Permanent teeth appearing.					1	2
	Characteristic Behavior —Eager to learn, restless, overactive, easily fatigued. Aggressive, wants to be first, boastful.						
	SPECIAL NEEDS —Encouragement, praise, warmth, and patience from adults. Opportunity for activity of many kinds, especially for large muscles. Some responsibilities, but without pressure. A best friend.						
3	4	5	6	7	8	9	
		ELECTION DAY SCHOOL OPEN PTA Cake Sale, Forest 10 a.m. to 4 p.m.	PTA Exec. Bd. Mtg., Forest, 8:15 p.m. PTA Exec. Bd. Mtg., Shaw, 8:30 p.m.	PTA Exec. Bd. Mtg., Clear Stream, 8 p.m.			
10	11	12	13	14	15	16	
	VETERANS DAY SCHOOL CLOSED	C.H.S. Board Meeting, 8 p.m.	PTA Workshop, Forest, 10 a.m.	PTA Teacher-Faculty Night, Clear Stream, 8 p.m.		PTA Movies for Children, Shaw Avenue	
17	18	19	20	21	22	23	
			Pre-sch. Mt., Forest, 3 p.m.—Report Cards sent out today— PTA Gen. Mt., Shaw Parent Ed., Afternoon		PTA Show, Forest, 8:30 p.m.	PTA Show, Forest, 8:30 p.m.	
24	25	26	27	28	29	30	
		Dist. No. 30 Bd. of Ed. Meeting, 8:15 p.m.	SCHOOL CLOSES AT NOON	THANKSGIVING RECESS	THANKSGIVING RECESS		

CLEAR STREAM AVENUE PARENT TEACHER ASSOCIATION

ELECTED OFFICERS 1968-1969

dent	Lois Barry	CU 5-8654
Vice President	Jeanette Ermler	VA 5-6368
nd Vice President	Ruth Cornish	872-3020
urer	Dorothy Wirth	VA 5-6261
bership	Dolores O'Leary	VA 5-5943
	Pat Strobl	825-4640
rding Secretary	Muriel Watterson	825-5478
esponding Secretary	Josephine Balsano	CU 5-9700
ates to V. S. Council	Rose Weltsek	LO 1-1038
	Judith McCloskey	Faculty
Presidents	Marion Bourne	561-8237
	Connie Deering	CU 5-6210

COMMITTEE CHAIRMEN

and Flyers	Joy Roccanova	285-8860
o-Visual	Frank DeMarco	Faculty
et	Muriel Watterson	825-5478
ral Arts	Marion Bourne	561-8237
h and Mental Health	Connie Deering	CU 5-6210
rian	JoPat Minerva	VA 5-7433
lation	Margie Croak	VA 5-9352
rian	Melba Williams	LO 1-9774
ographers	Peggy Carlson	CU 5-8857
it Education	Rita DiStefano	VA 5-2169
mentarian and By Laws	Lorraine Schroeder	825-1102
chool	Hilda Flynn	VA 5-6081
	Lee Cohen	CU 5-5668
	Jeanette Ermler, Chrm.	VA 5-6368
	Anna Docar	CU 5-8914
	Marie Spitzfaden	285-6161
	Ruth Cornish	872-3020
	Livia Daria	CU 5-6025
	Arlene Drogos	561-6372
	Cathy Eggolt	CU 5-7873
	Muriel Grancher	CU 5-7637
	Elena Cirenza	CU 5-5671
	Dorothea Munson	LO 1-2547
	Alice Lizza	CU 5-8490
	Kay Ciccone	LO 1-9207
	Helen Martino	CU 5-5834
	Doris Horowitz	825-2865
	Gloria Gargiulo	825-4074

Ways & Means; Chrm. & Movies	Kay Schmidt	872-8692
Book Mobile	Rose Vespucci	LO 1-2962
Bowling	Pat Strobl	825-4640
Cake Sale	Mary Tragner	CU 5-9502
Hospitality	Gloria Corradi, Chrm.	CU 5-5255
	Lorraine Schroeder	825-1102
Typists	Marie Pascuzzi	VA 5-8401
	Marilyn Margolies	CU 5-8973
	Margie Croak	VA 5-9352
Welcoming Committee	Rose Vespucci	LO 1-2962
Kindergarten Rep.	Mary Tragner	CU 5-9502
1st Grade Rep.	Lillian Serpico	LO 1-0117
2nd Grade Rep.	Josephine Coyle	CU 5-7731
3rd Grade Rep.	Ann Prisco	CU 5-5744
4th Grade Rep.	Pat Strobl	825-4640
5th Grade Rep.	Evelyn Pearlman	CU 5-5723
6th Grade Rep.	Rita DiStefano	VA 5-2169

P.T.A. PROGRAM

Sept.	5	Executive Board Meeting, 8 p.m.
	19	PTA General Meeting, "Meet the Teachers & Grade Teas" 8 p.m.
Oct.	3	Executive Board Meeting, 1:15 p.m.
	17	PTA Workshop, 1:30 p.m.
	21	Children's Movie
	31	5th and 6th Grade Hallowe'en Party (p.m.)
Nov.	7	Executive Board Meeting, 8 p.m.
	14	Father-Faculty Night, 8 p.m.
Dec.	5	PTA General Meeting, 8:15 p.m.
	19	Children's Holiday Assembly Program
Jan.	9	Executive Board Meeting, 1:15 p.m.
	23	Pre-School Workshop
	30	Executive Board Meeting, 8 p.m.
Feb.	6	Founder's Day, 8:15 p.m.
March	6	Executive Board Meeting, 8 p.m.
	14	Father, Son and Daughter Night, 7:30 p.m.
	27	PTA General Meeting, 8:15 p.m.
April	24	Cake Sale
May	7	Executive Board Meeting, 1:15 p.m.
	15	PTA General Meeting, Installation, 8:15 p.m.
	20	Teachers' Recognition Day — Luncheon
	22	Pre-School Workshop
	26-29	PTA Book Fair
June	5	Joint Board Meeting, 8 p.m.

D E C E M B E R 1 9 6 8

DAY	MONDAY	TUESDAY	WEDNESDAY	THURSDAY	FRIDAY	SATURDAY
1	2	3	4	5	6	7
	SCHOOL REOPENS V.S. PTA Council Mt., Corona Avenue		PTA Cake Sale, Shaw, 10 a.m. to 3:30 p.m. PTA Exec. Bd. Mtg., Shaw, 8:30 p.m.	Pre-school Mtg., Shaw, 3:00 to 3:30 p.m. PTA Gen. Meeting, Clear Strm., 8:15 p.m.		
8	9	10	11	12	13	14
		C.H.S. Board Meeting, 8 p.m.	Pre-sch. Mtg., Forest, "Fun With Art," Part 1 2 p.m.		PTA Book Fair, Forest, 7:30 p.m. PTA Holiday Assembly for Children, Shaw	PTA Book Fair, Forest, 10 a.m.
15	16	17	18	19	20	21
KAH		Dist. No. 30 Bd. of Ed. Meeting, 8:15 p.m.	PTA Holiday Gift to Children, Forest	PTA Holiday Assembly Clear Stream	SCHOOL CLOSSES AT REGULAR TIMES	
22	23	24	25	26	27	28
	CHRISTMAS RECESS	CHRISTMAS RECESS	CHRISTMAS DAY	CHRISTMAS RECESS	CHRISTMAS RECESS	
29	30	31	<p>AGE SEVEN: <i>Physical Development</i>—Expected growth in height is 2 to 3 inches, in weight—3 to 6 pounds. Most will lose teeth and have 6 year molars.</p> <p><i>Characteristic Behavior</i>—Dependent on approval of adults. Interests of boys and girls diverging. Cautious and self-critical. Anxious to do things well. Talkative.</p> <p><i>SPECIAL NEEDS</i>—Acceptance at own developmental level. Chances for active participation in learning with concrete objects. Great joy at receiving gifts for Hanukah or Christmas.</p>			
	CHRISTMAS RECESS	CHRISTMAS RECESS				

FOREST ROAD PARENT TEACHER ASSOCIATION

ELECTED OFFICERS 1968-1969

President	Mrs. Marjorie Grauer	PY 1-6043
First Vice President	Mrs. Eleanor Klein	PY 1-3060
Second Vice President	Mrs. Gertrude Myron	PY 1-2386
Third Vice President	Mrs. Ruth Weinstein	PY 1-9045
Treasurer	Mr. Lawrence Schoen	PY 1-6227
Public Secretary	Mrs. Anita Strelisker	PY 1-7167
Communications Secretary	Mrs. Muriel Roth	PY 1-4090
Recording Secretary	Mrs. Lillian Spector	PY 1-2627
Delegate to Council	Mrs. Arlene Glass	PY 1-8088

COMMITTEE CHAIRMEN

Budget	Anita Strelisker	PY 1-7167
Class Mother	Julia Fisher	PY 1-5574
Class Mother	Alberta Schechtman	PY 1-3471
Family Living (Mental Health, Parent Ed., Excep. Chil.)	Iris Casson	PY 1-4727
Flyers	Pompi MacLeod	PY 1-7072
Goodwill	Francine Eisenstadt	PY 1-4840
Hospitality	Beth Stern	PY 1-7864
Health & Safety	Cecilia Niederman	PY 1-2131
Historian	Anna DeLeo	PY 1-2305
Legislation	Pearl Lustbader	PY 1-9547
Library & Book Fair	Marjorie White	PY 1-5361
Membership	Bernice Eisenberg	PY 1-6792
Mimeograph	Emma Breman	PY 1-5070
Music & Art	Stella Appenzeller	PY 1-7847
Newsletter	Ronnie Blanck	PY 1-4642
Parliamentarian	Marlyn Fogel	PY 1-4701
Pre-School	Marcia Chaiet	PY 1-2641
Publicity	Roslyn Eisenberg	PY 1-3246
School & Comm. Relations	Louise Epstein	PY 1-3959
School Bd. Rep. - Elem.	Debbie Zarchy	PY 1-7039
School Bd. Rep. - H.S.	Lawrence Schoen	PY 1-6227
Teacher Rep.	Corky Shaw	PY 1-8807
Typist	Selma Singer	PY 1-3592
News & Means	Carol Andiman	PY 1-4686
	Renaye Lehman	PY 1-5484
	Ruth Weinstein	PY 1-9045
	Phyllis Abelow	PY 1-7951
	Virginia Bendin	PY 1-7676
	Madeline Margulies	PY 1-5097
	Pompi MacLeod	PY 1-7072
	Kitty Chimbel	PY 1-6642
	Len Wolff	PY 1-8391
	Phyllis Wolin	PY 1-8012
	Marie D'Alessandro	PY 1-4194
	Olga Noto	PY 1-2310

P.T.A. PROGRAM

Aug. 28	PTA Executive Board Meeting 8:15 p.m.
Sept. 4-5	PTA Book Cover Sale 2:45 p.m.
11	Class Mother Meeting 8:15 p.m.
18	PTA General Meeting — "Meet The Teacher Night" 8:15 p.m.
Oct. 9	PTA Executive Board Meeting 8:15 p.m.
23	PTA General Meeting 8:15 p.m.
30	6th Grade Halloween Party
Nov. 5	PTA Cake Sale 10:00 a.m. to 4:00 p.m.
6	PTA Executive Board Meeting 8:15 p.m.
13	PTA Workshop 10:00 a.m.
20	Pre-school Meeting—"Let's Get Acquainted"—Mrs. Reinken 3:00 p.m.
22	PTA Show 8:30 p.m.
23	PTA Show 8:30 p.m.
Dec. 11	Pre-school Meeting — "Fun With Art," Part I Children with Mrs. Steinman, Parents with Mrs. Keaney 2:00 p.m.
13	PTA Book Fair 7:30 to 9:00 p.m.
14	PTA Book Fair 10:00 a.m. to 12:00 p.m.
18	PTA Holiday Gift to the Children
Jan. 8	PTA Executive Board Meeting 8:15 p.m.
15	Pre-school Meeting — "Fun With Art," Part II Children with Mrs. Steinman, Parents with Mrs. Keaney 2:00 p.m.
22	PTA Workshop 1:00 p.m.
25	International Day 11:00 a.m. to 4:00 p.m.
Feb. 5	PTA Executive Board Meeting 8:15 p.m.
19	Pre-school Meeting — "Let's Make Music" — Children with Miss Butler, Parents with Mrs. Reinken — 3:00 p.m.
March 5	PTA Executive Board Meeting 8:15 p.m.
12	Pre-school Meeting — "Let's Have Fun" — Children with Mrs. Reinken, Parents with Mrs. Rosenfeld — 3:00 p.m.
26	PTA General Meeting — Election of Officers — 8:15 p.m.
April 14	Sex-Hygiene Meeting, 6th Grade Parents 8:15 p.m.
15	6th Grade Girls — Sex-Hygiene Meeting 2:45 p.m.
16	Pre-school Meeting — "Tell Me A Story" — Children with Mrs. Mueller, Parents with Mrs. Pollett — 2:00 p.m.
16	5th Grade Girls — Sex-Hygiene Meeting Mrs. Steinman 2:45 p.m.
17	6th Grade Boys — Sex-Hygiene Meeting 8:00 p.m.
23	PTA Workshop 1:00 p.m.
May 7	PTA Executive Board Meeting 8:15 p.m.
14	Teacher Recognition Day Luncheon 11:30 a.m. to 1:00 p.m.
21	PTA General Meeting — Installation of Officers 8:15 p.m.
June 4	PTA Joint Boards Meeting 8:15 p.m.

JANUARY 1969

SUNDAY	MONDAY	TUESDAY	WEDNESDAY	THURSDAY	FRIDAY	SATURDAY
			1	2	3	4
HT: Physical Development—Eyes ready for both near and far. Attention span is increasing. Poor posture may develop. Imitative Behavior—More dependent on his mother again, less on his father. Gangs beginning. Fond of team games, comics, TV, movies. NEEDS—Reminders of responsibilities. Praise and encouragement from adults. Experience belonging to peer group.			NEW YEAR'S DAY	SCHOOL REOPENS		
5	6	7	8	9	10	11
		Pre-school Meeting, Shaw and Washington, 3:00-3:30 p.m.	PTA Exec. Bd. Mtg., Forest, 1:00 p.m. PTA Exec. Bd. Mtg., Shaw, Afternoon	PTA Exec. Bd. Mtg., Clear Strm., 1:15 p.m.		
12	13	14	15	16	17	18
		C.H.S. Board Meeting, 8 p.m.	Pre-school Meeting, Forest, "Fun With Art," Part 2, 2 p.m.			
19	20	21	22	23	24	25
			PTA Workshop Forest, 1:00 p.m.	PTA Pre-school Mtg., Clear Stream		International Day Forest, 11 a.m. to 4 p.m.
26	27	28	29	30	31	
		Dist. No. 30 Bd. of Ed. Meeting, 8:15 p.m.		PTA Exec. Bd. Mtg., Clear Stream, 8 p.m.		

SCHOOL ADMINISTRATION

Paul W. Rossey, District Superintendent

Sherwood S. Quick
District Principal

SCHOOL PRINCIPALS

CLEAR STREAM AVENUE SCHOOL
Lawrence O. Lobdell

FOREST ROAD SCHOOL
Maurice E. St. Mary

SHAW AVENUE SCHOOL
John A. Busch
George W. Niederhauser, Assistant Principal

Elementary Consultant
William Van Ness

SCHOOL SECRETARIES

Mrs. Jeanne Feeney, Clear Stream Avenue
Mrs. Mary McDowell, Forest Road
Mrs. Jean Annona, Shaw Avenue

DISTRICT SECRETARIAL STAFF

Garet Bradley Lucy Felice Helen Kuchler
nie O'Connell Marcella Pantaleo Mary Ribando
Edythe Sanchez Caroline Young

Evelyn Pearn, Cafeteria Manager

DISTRICT SPECIALISTS AND SPECIAL TEACHERS

Frank DeMarco, Audio-Visual Consultant
Rosalyn Kessler, Psychologist
Estelle Friedman, Psychologist
Raydine Teicheira, Speech Consultant
Frances Pollet, Speech Teacher
Agnes Mabry, Reading Consultant
Dolores Stein, Foreign Language Consultant
Lawrence Cid, Mathematics Consultant
John Price Instrumental Music Teacher
Margo Gushin, Instrumental Music Teacher

OTHER SPECIALISTS AND SPECIAL TEACHERS

Clear Stream Avenue School
Cathleen Meneilly, Special Counselor
Janet Poppe, Reading Specialist
Grace Giacobone, Art
Philip Hessemer, Physical Education
Joan Henningsen, Physical Education
Felicia Karolyi, Music
Ruth Newman, Librarian
Edna Giebel, Nurse-teacher

Forest Road School
Wayne Clavering, Special Counselor
Ada Keaney, Reading Specialist
Bernice Steinman, Art
Alfred Stevens, Physical Education
Joan Henningsen, Physical Education
Frances Butler, Music
Betty Mueller, Librarian
Hilda Rosenfeld, Nurse-teacher

Shaw Avenue School
Noel Giambalvo, Special Counselor
Jeanne Colton, Reading Teacher
Louise Holbrook, Art
Linda Sleiartin, Art
Joseph Reynolds, Physical Education
Joan Stein, Physical Education
Katherine Egan, Music
Linda Brody, Music
Sylvia Berkowitz, Librarian
Dorothy McCutchan, Nurse-teacher

FEBRUARY 1969

DAY	MONDAY	TUESDAY	WEDNESDAY	THURSDAY	FRIDAY	SATURDAY
	<p>AGES NINE & TEN: <i>Physical Development</i>—Slow, steady growth—girls forge further ahead. Teeth may need straightening. First and second bicuspid appear. Eyes almost adult size. Eye-hand coordination good. Ready for crafts and shop work. <i>Characteristic Behavior</i>—Dependable, responsible, strong sense of right and wrong. Abilities now apparent. Argues over fairness in games. Outspoken and critical. <i>SPECIAL NEEDS</i>—Friends and group membership. Books of many kinds. Explanations without talking down. Frank answers to physiological changes.</p>					1
2	3	4	5	6	7	8
	V.S. PTA Council Mtg., Clear Stream Ave.		PTA Exec. Bd. Mtg., Forest, 8:15 p.m. Report Cards Today PTA Exec. Bd. Mtg., Shaw, 8:30 p.m.	PTA Founders Day Clear Strm., 8:15 p.m.		
9	10	11	12	13	14	15
		C.H.S. Board Meeting, 8 p.m.	LINCOLN'S BIRTHDAY SCHOOL CLOSED	WINTER RECESS SCHOOL CLOSED	WINTER RECESS SCHOOL CLOSED	
16	17	18	19	20	21	22
	SCHOOL REOPENS		Pre-school Meeting, "Let's Make Music," Forest, 3 p.m.			WASHINGTON'S BIRTHDAY
23	24	25	26	27	28	
		Dist. No. 30 Bd. of Ed. Meeting, 8:15 p.m.				

SCHOOL POLICIES

SCHOOL HOURS

hours for grades 1, 2, and 3 are from 9:00 a.m. to 3:00 p.m.
hours for grades 4, 5, and 6 are from 8:30 a.m. to 2:45 p.m.

LUNCH

is served beginning with the first day of school. Pupils go for lunch, bring lunch from home, or buy the school lunch in the cafeteria for 30c. Monthly menus are provided so if foods are served which your child does not eat, you can make other provisions for him for those days. In case a child loses his lunch money or his lunch, or loses either, we have a system to cover the emergency. The cashier in the cafeteria keeps the record of such charges and contacts the parents if a charge not be paid in a reasonable time.

ICE CREAM

Ice cream is sold daily to those pupils who wish it. It is not sold with the hot lunch and costs an additional 10c.

RECESS MILK

Recess milk is available to all children beginning about the first week of the school year and is sold at a cost of 15c per week each Thursday for the following week. You will be notified as to the exact date. Money brought in late (Friday) cannot be accepted. In case of a child's absence, no refund is made for periods of less than a full week.

ABSENCES

If your child has been absent, State law requires that he bring a note from you explaining the absences and the date(s) of absence(s). The note should be presented to the nurse before coming to the classroom. Please be specific. Just saying, "he was sick" is not enough. Indicate whether it was "virus," "fever," "flu," etc. A note is required for an absence due to a religious observance. A note is required for any tardiness, giving the reason. If your child contracts a contagious disease, such as mumps, measles, etc., please phone the school nurse so that she can notify the parents in your child's class that their children have been exposed. Be sure to keep the emergency card up to date so that we will know whom to call should your child become ill and have to go home.

NOON HOUR RULES

When pupils misbehave in the cafeteria, auditorium, or on the playground during the noon hour, after repeated reminders, the teachers have the authority to exclude them from staying in school for lunch for a few days, or longer, depending on the misbehavior. If you receive such a note from us, we would appreciate your cooperation. Whether or not a mother is home during the noon hour has no bearing on this exclusion.

RELEASED TIME FOR RELIGIOUS INSTRUCTION

A Release Form signed by the parent is necessary should you want your child excused from school for religious instruction. Such forms can be obtained from your church. The time provided is the last hour of school on Wednesday afternoons.

EXITS AND ENTRANCES

Your child's class is assigned a specific exit and entrance to use. You will thus know where to meet him if you come to pick him up. Parents picking up children are asked to meet them at the exit, not the classroom.

ENTRANCE TIMES

Morning — All Schools	Noontime — Shaw & Forest
Grades 1, 2, & 3 — 8:50	Grades 1, 2, & 3 — 12:50
Grades 4, 5, & 6 — 8:20	Grades 4, 5, & 6 — 12:20
Noontime — Clear Stream:	Grades 5 & 6 — 12:05
Grades 3 & 4 — 12:35;	Grades 1 & 2 — 1:05

Because there is no supervision of the playground in the morning, we suggest you arrange your child's departure from home to allow him to arrive just in time to enter the building during the proper interval. In inclement weather he may come into the designated area five minutes before the above times.

CLASS INTERRUPTIONS

No unnecessary interruptions of classes are allowed once the day's sessions have begun. When your child forgets a book, homework, sneakers, lunch money, etc., please bring these to the office. All pupils are instructed to check with the office at lunch time for such forgotten items. In the interest of the child's all-round education, we urge you not to make a practice of bringing forgotten items to school. The child should be developing his own sense of responsibility for these things.

MARCH 1969

SUNDAY	MONDAY	TUESDAY	WEDNESDAY	THURSDAY	FRIDAY	SATURDAY
	AGES ELEVEN & TWELVE: Physical Development —A "resting period" followed by a period of rapid growth. Girls usually taller than boys. Enormous but capricious appetite. Uneven growth of different parts of the body. Characteristic Behavior —Gangs continue, more loyalty to the group. Marked interest differences between boys and girls. Group opinion valued. SPECIAL NEEDS —Understanding of coming physical changes. Warm affection and sense of humor in adults. No nagging or talking down.					1
2	3	4	5	6	7	8
		PURIM Pre-school Meeting, Shaw & Washington, 3:00-3:30 p.m.	PTA Exec. Bd. Mtg., Forest, 8:15 p.m. PTA Exec. Bd. Mtg., Shaw, 8:30 p.m.	PTA Exec. Bd. Mtg., Clear Stream, 8 p.m.		
9	10	11	12	13	14	15
		C.H.S. Board Meeting, 8 p.m.	Pre-school Meeting, Forest, 3 p.m. PTA Fashion Show, Shaw		PTA Father-Son- Daughter Night, Clear Strm., 7:30 p.m.	
16	17	18	19	20	21	22
	ST. PATRICK'S DAY		PTA Gen. Meeting (Mental Health) Shaw, Afternoon			
23	24	25	26	27	28	29
30	31	Dist. No. 30 Bd. of Ed. Meeting, 8:15 p.m.	PTA Gen. Meeting, Forest, 8:15 p.m.	PTA Gen. Meeting, Clear Stream, 8:15 p.m.		

SCHOOL POLICIES

GYM SUITS AND SNEAKERS

Gym suits are required of pupils below the 4th grade, but sneakers are necessary for any pupils using the gym. Boys and girls from the 4th through 6th grades are required to wear gym suits and sneakers on the assigned gym days. The gym teachers will explain this to the pupils, but many times they do not bring correct information home.

Who **MUST PURCHASE A NEW SUIT** should buy the **ROYAL BLUE**, bloomer type, with elastic bottoms, or **ROYAL BLUE** shorts with elastic insert in the cuff, and a white t-shirt. Boys should wear **ROYAL BLUE** shorts, with elastic top, and sneakers (high top ones preferred), and white or **SCHOOL "T"** shoes.

IF YOUR CHILD HAS ANOTHER COLOR, OR TYPE, HE DOES NOT NEED TO BUY A NEW ONE. The above apparel may be purchased at many local stores in Valley Stream. **NO ONE IS ALLOWED ON THE GYM FLOOR WITHOUT SNEAKERS.**

APPOINTMENTS WITH TEACHERS

Remember that pupils' classtime be used to the fullest advantage, so request that parents do not seek conferences with teachers during school hours. If you wish a conference, please make an appointment to see the teacher after school. Teachers are available for such conferences every day except Mondays and Fridays.

BICYCLES

Bicycles are allowed at either Forest Road or Clear Stream Elementary Schools because no child lives far enough from the school to make them necessary. They are allowed at Shaw, but are restricted to pupils in grades 4, 5, and 6 who live **NORTH OF CLEAR AVENUE**. Bicycles used to come to the Shaw Avenue School will be assigned a number. All must have a lock and reflectors for safety purposes.

GIFTS TO TEACHERS PROHIBITED

Policy of the school district which became effective January 1, 1956, is to prohibit the acceptance of gifts by faculty members on school premises, and to prohibit the solicitation of funds for personal gifts purposes, by any person, or persons, on the premises.

IN-DAY PROGRAM

In inclement weather, there is an in-day program of motion pictures provided for those pupils who eat in the cafeteria. Pupils who go home to lunch are not allowed to participate in this program because of space limitations, so we ask parents to return these pupils to school on such days just in time for the afternoon session—not before 12:50 p.m. for grades 1 to 3, and 12:20 p.m. for grades 4 to 6 at Shaw and Forest; and not before 12:05 for grades 5 and 6, 12:35 for grades 3 and 4, and 1:05 for grades 1 and 2 at Clear Stream.

HOMEWORK REQUIREMENTS

Homework is required of all pupils, but it will vary from day to day. First and second grade pupils may have fifteen to twenty minutes of homework per day, while third and fourth grade pupils are likely to have thirty to forty minutes. Fifth and sixth graders are expected to devote as much as an hour to homework, but again this may not be every day—it will depend on the pupil and his needs.

LOST AND FOUND

Unmarked articles lost by pupils are placed in the Lost-and-Found, which is in the Nurse's Office. Such articles, if not claimed at the end of the school year, are given to a charitable organization. However, any articles bearing a child's name is returned directly to him. Please place your child's name on all his belongings.

STAYING AFTER SCHOOL

To eliminate any confusion or problems, the school may have your child every day for an additional half hour. During this half hour beyond the regular school day, the teacher may schedule your child for special help or keep him for any of several reasons. We ask that you keep this in mind and not schedule dental appointments, dancing lessons, etc. until after that interval. Teachers are also available to parents during the half hour after school, except on Monday and Friday, for conferences. Appointments are not necessary, but it is to your advantage to make one, so that you can be sure of the teacher's availability.

ASSEMBLIES

When your child's class puts on the assembly, we welcome your attendance, but we do ask you not to bring pre-school children. As much as we realize that it is a thrill for them to see big brother perform, they are often distracting to all concerned.

APRIL 1969

DAY	MONDAY	TUESDAY	WEDNESDAY	THURSDAY	FRIDAY	SATURDAY
		1	2	3	4	5
			SCHOOL CLOSING AT REGULAR TIMES	PASSOVER EASTER RECESS SCHOOL CLOSED	PASSOVER GOOD FRIDAY SCHOOL CLOSED	
6	7	8	9	10	11	12
SUNDAY	EASTER RECESS	C.H.S. Board Mtg., 8 p.m. EASTER RECESS	CONCLUSION OF PASSOVER EASTER RECESS	CONCLUSION OF PASSOVER EASTER RECESS	EASTER RECESS	
13	14	15	16	17	18	19
	SCHOOL REOPENS Sex Hyg. Mt., 6th Gd. Parents, Forest, 8:15 V.S. PTA Council Mtg., Howell Road	Sex Hygiene Meeting, 6th Grade Girls, Forest, 2:45 p.m.	Report Cards Pre-school Mt., Forest, 2 p.m.; Sex Hyg. Mt., 5th Gd. Girls, Forest, 2:45 p.m.; PTA Ex. Bd. Mt., Shaw, 8:30 p.m.	Sex. Hygiene Meeting, 6th Grade Boys, Forest, 8 p.m.		
20	21	22	23	24	25	26
	PTA Bookmobile Shaw (All Week)	Dist. No. 30 Bd. of Ed. Meeting, 8:15 p.m.	PTA Gen. Meeting Workshop, Forest, 1 p.m.	PTA Cake Sale, Clear Stream	Registration for Next Year's Kindergarten, Each School, 9-11 a.m.	Registration for School Voting 7 a.m. to 12 Noon, Each School
27	28	29	30	PUPIL MALAPROPISM: The process of turning steam into water again is called conversation. —NEA Journal "In the adolescent years, the most important quality a youngster needs is fidelity—someone who will trust him, someone he can trust."—ERIC ERICSON		

THE SCHOOL BUDGET

Many school budgets going down to defeat this past school year, it is our feeling that the taxpayers should be more informed in regard to this part of the school program.

Like our own personal budgets, school budgets have been greatly affected by the increased costs in all areas. Costs of paper, pencils, textbooks, fuel oil, repairs and maintenance of buildings have all risen, to mention only a few items. The largest increase in school budgets has been employee salaries for the same reasons that salaries in business have risen. In addition, new mandates from the State of New York have required boards of education to pay more and more of the costs of teacher retirement and other fringe benefits without monetary help from the State. Your Board of Education is nothing to say about such increases; they are required by law to comply. This part of the school budget represents from 80 to 85% of the budget.

The other 15 to 20% of the budget covers items such as cafeteria, summer recreation programs, interscholastic sports, new equipment, new textbooks, renovations to the buildings, extra-curricular activities, use of the building by community

groups, and the like. These are the items which are usually eliminated when a district must go on an austerity budget. They are also some of the most important as was shown by a study made by the Metropolitan School Study Council of a few years ago. This study showed that where a school district spent adequate money on these parts of the budget, there was a positive correlation between amount of money spent and the excellence of the school program.

For the resident who really wishes to have something to say about the school budget, we advise you to keep aware of what the New York State legislature considers at each legislative session when bills are introduced which concern education. Your Parent-Teacher Associations keep well abreast of these matters and can inform you. After you have gained the facts, then make your feelings known to your representatives to help guide how they vote on such matters. Your own Board of Education begins formulating the budget each January. Attendance at its regular monthly meetings will help keep you informed. Look for the meeting dates in this calendar. All meetings are held at the Shaw Avenue School and begin at 8:15 p.m.

MAY 1969

DAY	MONDAY	TUESDAY	WEDNESDAY	THURSDAY	FRIDAY	SATURDAY
				1 Registration for School Voting 4 to 10 p.m.	2	3
4	5	6	7 PTA Ex. Bd. Mts., For- est, 8:15; Shaw, 8:30; Clear Str., 1:15 p.m. VOTING ON SCHOOL BUDGET, 7 a.m.-10 p.m.	8	9	10
11 S DAY	12	13 C.H.S. Board Meeting, 8 p.m. Teacher Recognition Day Luncheon, Shaw	14 Teacher Recognition Day Luncheon, Forest, 11:30 - 1:00	15 Art Exhibit, Clear Stream, 7:30-9 p.m. PTA Gen. Mtg., Clear Stream, 8:15 p.m.	16	17
18	19	20 Art Exhibit, Forest, 7:30-9 p.m.; Teacher Recognition Day Luncheon, Clear Strm.	21 PTA Gen. Mtg., Inst. of Officers, Forest, 8:15 p.m., Shaw, 8:15	22 Art Exhibit, Shaw, 7:30 - 9 p.m. Pre-school Meeting, Clear Stream	23	24
25 Registration for Next Year's Kindergarten, Each School, 9-11 a.m. PTA Book Fair, Clear Stream	26 Dist. 30 Bd. of Ed. Meeting, 8:15 p.m. PTA Book Fair, Clear Stream	27	28 PTA Book Fair, Clear Stream	29 PTA Book Fair, Clear Stream	30 MEMORIAL DAY SCHOOL CLOSED	31

RECOMMENDED TOURS

ore experiences a child has, the better he is able to cope
ool when he finally attends. Thus we are listing for the
on of parents, a few of the best places in this area where
take your child on weekends and holidays. You may find
you as a parent will enjoy these visits.

NASSAU & SUFFOLK COUNTIES

RT HISTORICAL SOCIETY MUSEUM— 350 S. Main
ort. Civil War and Local material, transportation displays.

SSET VALLEY SCHOOLHOUSE—Manhasset Valley
nhasset. Open April 1 to Oct. 31. Free. Nassau's oldest
school, 1820.

COUNTY HISTORICAL MUSEUM—Salisbury Park,
adow. Free. Exhibits depicting Nassau from prehistoric
present.

AL HISTORY MUSEUM—Washington Ave., Seaford.
n 25c. Natural History exhibits.

AM HALL—20 W. Main St., Oyster Bay. Adults 50c,
free. British headquarters during Revolution. Colonial &
furnishings.

ALL—Town of Hempstead Museum. Broadway, Lawrence.
lt in 1767, one of the best examples of Georgian archi-
U.S. Period furnishings, Civil War room.

MILL MUSEUM—1347 Old Northern Blvd., Roslyn.
lt 1701, visited by George Washington 1790. Guns, in-
bjects, clothing from Revolutionary period.

SAGAMORE HILL—Cove Neck Road, Oyster Bay. Adults 50c,
children free. Built in 1884 by Theodore Roosevelt, later used as
his summer White House. Original furnishings and Roosevelt
mementos.

THEODORE ROOSEVELT MEMORIAL SANCTUARY—Cove
Rd., Oyster Bay. Free. National Audobon Society sanctuary and mu-
seum. Adjoins Theodore Roosevelt grave.

CLINTON ACADEMY & TOWN HOUSE—Main St., East Hamp-
ton. Adults 50c, children 25c. Built 1784. Whaling and Indian
relics.

CUSTOMS HOUSE—Madison St., Sag Harbor. Adults 50c, chil-
dren 25c. Built 1790, first custom house in State, first Post Office
on Long Island.

HECKSCHER ART MUSEUM—Prime Ave., Huntington. Free.
Paintings from 16th to 20th centuries, European, English, French
and American. Sculpture and Minerals.

LONG ISLAND AUTOMOTIVE MUSEUM—Route 27 North
Highway, Southampton. Adults \$1.00, children 50c. Cars 1896 to
present. Restoration shop and fire engine rides.

PARISH ART MUSEUM—Job's Lane, Southampton. Free. Amer-
ican Paintings of all periods. Sculpture.

SUFFOLK MUSEUM—Christian Ave., Stony Brook. Adults 50c,
children 35c. L. I. Indian & plant exhibits, 3 art galleries, 19th
Century country store and cobbler's shop.

WALT WHITMAN HOUSE—216 Walt Whitman Road,
Huntington Station. Free. Built in 1810. House of early youth of
poet. Furnished as farmhouse of period.

JUNE 1969

DAY	MONDAY	TUESDAY	WEDNESDAY	THURSDAY	FRIDAY	SATURDAY
1	2 V.S. Council of P.T.A. Meeting North High School	3	4 PTA Joint Bds. Mtg., Forest, 8:15 p.m.	5 PTA Joint Bds. Mtg., Clear Strm, 8 p.m.	6	7
8	9	10 C.H.S. Board Meeting, 8 p.m.	11 PTA Exec. Bd. Meeting, Shaw, 8:30 p.m.	12	13	14 FLAG DAY
15 S DAY	16	17	18 GRADUATION	19	20 LAST DAY OF SCHOOL	21
22	23 ANNUAL SCHOOL CENSUS BEGINS	24 Dist. No. 30 Bd. of Ed. Meeting, 8:15 p.m.	25	26	27	28
29	30 Summer Recreation Program Begins	<p>"If structure and pavement take over the world entirely, if green places and growing things have no guarded life, then man will go through the years deprived and lopsided. He will be poor, whatever the gadgetry of affluence around him." —AUGUST HECKSCHER</p>				

UNION FREE SCHOOL DISTRICT No. 30 AND
CENTRAL HIGH SCHOOL DISTRICT No. 1,
VALLEY STREAM, NEW YORK

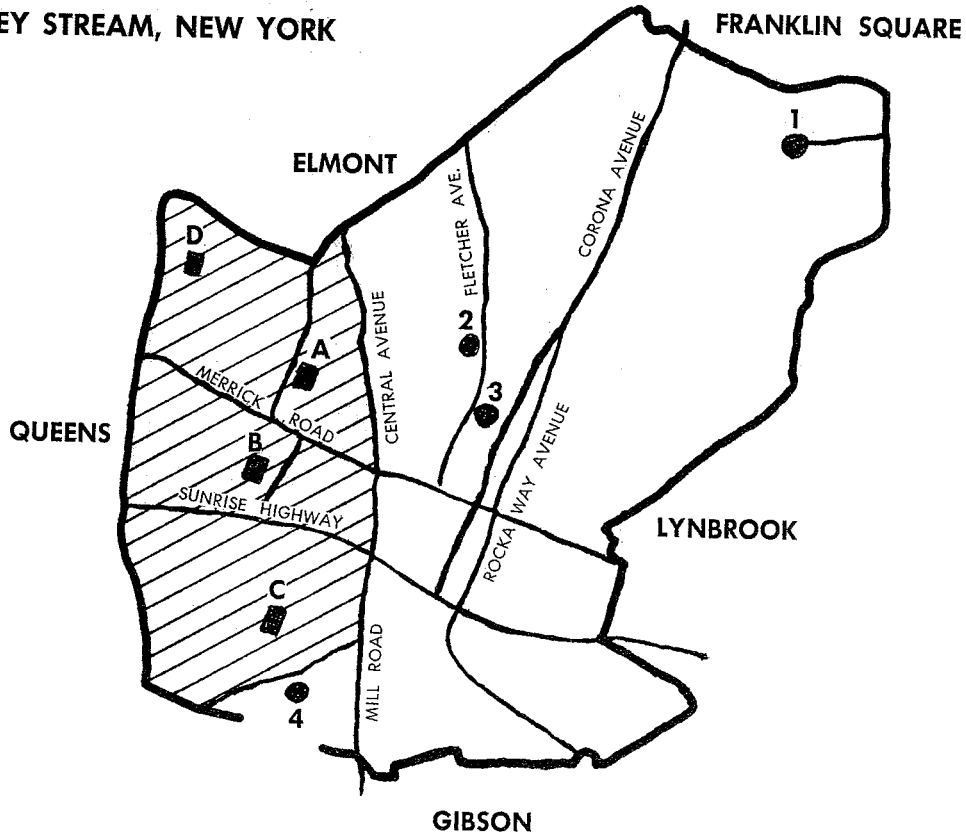

DISTRICT No. 30 SCHOOLS

- Shaw Avenue A
- Clear Stream Avenue B
- Forest Road C
- Washington Avenue D

Shaded Area — District 30

HIGH SCHOOLS

- North High 1
- Memorial Junior 2
- Central High 3
- South High 4

ONE MILE

JULY 1969

DAY	MONDAY	TUESDAY	WEDNESDAY	THURSDAY	FRIDAY	SATURDAY
		1 Dist. No. 30 School Board Reorganization Mtg.	2	3	4 INDEPENDENCE DAY	5
6	7	8 C.H.S. Board Meeting, 8 p.m.	9	10	11	12
13	14	15	16	17	18	19
20	21	22 Dist. No. 30 Bd. of Ed. Meeting, 8:15 p.m.	23	24	25	26
27	28	29	30	31	"No democracy like the American can survive unless it can develop an aristocracy of virtue and talent." —THOMAS JEFFERSON	

CLEAR STREAM AVENUE SCHOOL

CLASS MOTHER LIST

Room	Class Mother	Tel. Number	Teacher
30)	Frances Esposito	285-9438	Mrs. Roth
30)	Ann Impellizzeri	285-4999	Mrs. Roth
:00)	Eleanor King	LO 1-6254	Miss Eden
:00)	Norma Rodriguez	LO 1-1382	Miss Eden
30)	Carol Hand	825-8660	Miss Eden
30)	Margie McGovern	CU 5-9011	Miss Eden
B	Marie Grande	LO 1-1848	Mrs. Schaaf
B	Mary Ammann	CU 5-6090	Mrs. Schaaf
7	Kay Schmidt	872-8692	Mrs. Williams
7	Dorothy Walz	825-8011	Mrs. Williams
8	Ann Prisco	CU 5-5744	Mrs. Riccobono
8	Marion Acquavella	VA 5-2272	Mrs. Riccobono
2	Jeanette Ermler	VA 5-6368	Mrs. Guberman
2	Marie Pascuzzi	VA 5-8401	Mrs. Guberman
5	Terry Keller	CU 5-7016	Mrs. Galati
5	Nancy Caravana	LO 1-7025	Mrs. Galati
6	Mildred Herber	CU 5-4861	Miss Patterson
6	Dolores O'Leary	VA 5-5943	Miss Patterson
1	Joy Rocanova	285-8860	Miss Firpo
1	Josephine Giannini	285-5090	Miss Firpo
3	Gloria Gargiulo	825-4074	Miss Tracy
3	Rose Vespucci	LO 1-2962	Miss Tracy
4	Miriam Cohen	825-9330	Miss LeJeune
4	Claire DiNapoli	CU 5-6275	Miss LeJeune
23	Irene Kielawa	LO 1-1075	Miss Galbraith
23	Connie Jurcsak	872-3916	Miss Galbraith
23	Kay Schmidt	872-8692	Miss Galbraith
25	Marion Russo	872-3233	Miss Yelland
25	Joan King	CU 5-9718	Miss Yelland
25	Dot Balazs	LO 1-1996	Miss Yelland
26	Gloria Corradi	CU 5-5255	Mrs. McCloskey
26	Rose Paladino	CU 5-8405	Mrs. McCloskey
27	JoPat Minerva	VA 5-7433	Miss Donahue
27	Barbara Rizos	CU 5-5218	Miss Donahue
28	Josephine Balsano	CU 5-9700	Mrs. Wicht
28	Hilda Flynn	VA 5-6081	Mrs. Wicht
21	Ruth Kane	LO 1-0865	Miss Pincus
21	Gloria Ryczek	CU 5-7291	Miss Pincus
22	Doris Moser	VA 5-1596	Mr. Cooper
22	Jennie Tretola	LO 1-2527	Mr. Cooper
24	Pat DeMayo	VA 5-5290	Miss Cooper
24	Rose Weltsek	LO 1-1038	Miss Cooper

FOREST ROAD SCHOOL

CLASS MOTHER LIST

Class Mother Chairmen

Julia Fisher, PY 1-5574 and Alberta Schechtman, PY 1-3471

Grade	Room	Class Mother	Tel. Number	Teacher
*K	AM	201 Marie D'Alessandro	PY 1-4194	Mrs. Reinken
K	AM	201 Elaine Wayne	PY 1-4870	Mrs. Reinken
K	PM	201 Irene Bochner	PY 1-6351	Mrs. Reinken
K	PM	201 Marjorie White	PY 1-5361	Mrs. Reinken
*1		203 Selma Singer	PY 1-3592	Miss Cafiso
1		203 Sylvia Haskel	PY 1-7905	Miss Cafiso
1		204 Nina Weitzner	PY 1-9615	Mrs. Burns
1		204 Sally Newman	PY 1-6743	Mrs. Burns
*2		205 Charlotte Hellreich	PY 1-4093	Miss Perrich
2		205 Renee Pepper	PY 1-3857	Miss Perrich
2		205 Marcia Balaban	PY 1-7598	Miss Perrich
2		206 Evelyn Levy	PY 1-2651	Miss Post
2		206 Marlyn Fogel	PY 1-4701	Miss Post
*3		207 Francine Eisenstadt	PY 1-4840	Mrs. Cummings
3		207 Bernice Eisenberg	PY 1-6792	Mrs. Cummings
3		207 Olga Noto	PY 1-2241	Mrs. Cummings
3		209 Rhoda Kagan	PY 1-9809	Miss Clarke
3		209 Iris Casson	PY 1-4727	Miss Clarke
4		208 Cecile Barnett	PY 1-8114	Miss Duck
4		208 Carolyn Green	PY 1-7946	Miss Duck
*4		210 Lillian Spector	PY 1-2627	Miss Bendin
4		210 Anita Strelisker	PY 1-7167	Miss Bendin
4		211 Ruth Berger	PY 1-5328	Miss Nancken
4		211 Sally Newman	PY 1-6743	Miss Nancken
5		214 Dotti Singer	PY 1-9361	Mrs. Groper
5		214 Sylvia Rabin	PY 1-8837	Mrs. Groper
*5		216 Rita Renko	PY 1-3477	Mrs. Neuman
5		216 Kitty Chimmel	PY 1-6642	Mrs. Neuman
*6		217 Corky Shaw	PY 1-8807	Mr. Beyer
6		217 Elaine Lieberthal	PY 1-5098	Mr. Beyer
6		217 Elaine Waldman	PY 1-3140	Mr. Beyer
6		217 Arlene Glass	PY 1-8088	Mr. Beyer
6		218 Eileen Silver	PY 1-2060	Mrs. Melnick
6		218 Lennette Wolff	PY 1-8391	Mrs. Melnick
6		218 Terry Dolgov	PY 1-5670	Mrs. Melnick
6		218 Barbara Taylor	PY 1-7730	Mrs. Melnick
6		220 Harriet Bishop	PY 1-5199	Mr. Kaufmann
6		220 Marlene Schoen	PY 1-6227	Mr. Kaufmann
6		220 Beverly Brosterman	PY 1-7021	Mr. Kaufmann
6		220 June Kaye	PY 1-2689	Mr. Kaufmann

*Grade Coordinator

AUGUST 1969

DAY	MONDAY	TUESDAY	WEDNESDAY	THURSDAY	FRIDAY	SATURDAY
					1	2
	3	4	5	6	7	8
					Summer Recreation Program Ends	9
	10	11	12	13	14	15
			C.H.S. Board Meeting, 8 p.m.			16
	17	18	19	20	21	22
	23					24
	25	26	27	28	29	30
	31					
						Dist. No. 30 Bd. of Ed. Meeting, 8:15 p.m.

I dream further of the emerging American who will be a unique individual in a society of diversity, but who will not cultivate a kind of atomistic individualism, one who will know that man can become a monster unless he forges the nexus that ties him by a sure human connection to his fellow human beings."—MAX LERNER

SHAW AND WASHINGTON AVENUE SCHOOLS

CLASS MOTHER LIST

Grade Representative Coordinator Lenore Schiff, LO 1-9575

Class Mother	Tel. Number	Teacher
Kindergarten Representative	Lois Plawsky, VA 5-4061	
AM Mrs. Gillman	285-9433	Mrs. Hartman
PM Mrs. Audino	285-6212	Mrs. Hartman
PM Mrs. Ricca	LO 1-8591	Mrs. Roth
AM Mrs. Fayet	561-6973	Miss Blessinger
PM Mrs. Cohen	VA 5-4301	Miss Blessinger

Grade Representative	Tel. Number	Teacher
Elaine Kagan, VA 5-1659		
Mrs. Kelly	825-0113	Mrs. Levine
Mrs. Jacobs	872-3144	Miss Davis
Mrs. Accardi	285-9823	Mrs. Kraft
Mrs. Mych	CU 5-8247	Mrs. Lazar

Grade Representative	Tel. Number	Teacher
Maureen Pascale, 825-0303		
Mrs. Amico	825-1753	Miss Cohen
Mrs. Mangino	872-8746	Miss Bellini
Mrs. Buehler	CU 5-6836	Mrs. Paradiso
Mrs. Lassig	825-2983	Mrs. Colletti

Grade Representative	Tel. Number	Teacher
Dee Robson, 825-0598		
Mrs. Donohue	VA 5-7507	Mrs. Sweet
Mrs. Davis	872-3938	Mrs. Strumpf
Mrs. Poche	VA 5-2742	Mrs. Stevens
Mrs. Goldfisher	CU 5-6227	Miss Sharkey

Gr.	Room	Class Mother	Tel. Number	Teacher
Fourth Grade Representative Sylvia Guttenplan, CU 5-7010				
4	106	Mrs. Dickinson	CU 5-9496	Miss Berlin
4	108	Mrs. Markowitz	285-5009	Mrs. Benedetto
4	109	Mrs. Ierardi	CU 5-6047	Mrs. Barnaby
4	110	Mrs. Thomas	825-2479	Mr. Riccobono
4	112	Mrs. Bedell	LO 1-7961	Mrs. Pokorny

Gr.	Room	Class Mother	Tel. Number	Teacher
Fifth Grade Representative Julia Score, LO 1-0120				
5	114	Mrs. Duberstein	CU 5-5392	Mrs. Wasserman
5	116	Mrs. Hunt	872-3963	Miss Schwartz
5	117	Mrs. Goldfisher	CU 5-6227	Mrs. Kaplan
5	118	Mrs. Brady	VA 5-5366	Mrs. Hamcke
5	122	Mrs. Horozan	CU 5-5706	Miss Murray

Gr.	Room	Class Mother	Tel. Number	Teacher
Sixth Grade Representative Norma Amitrano, 825-5508				
6	121	Mrs. Montalbano	825-0996	Miss Mack
6	123	Mrs. Drucker	CU 5-9677	Miss Lanell
6	124	Mrs. Block	CU 5-8428	Mrs. Sherman
6	125	Mrs. Grieco	VA 5-9139	Mrs. Rosche
6	127	Mrs. DeMarco	VA 5-8587	Mr. Giacalone
Special Cl.	131	Mrs. Cooper	825-7779	

SCHOOL TELEPHONE DIRECTORY

IN OFFICE: SHAW AVENUE SCHOOL

Principal VA 5-9131

Business Office VA 5-9131

Administrative Manager VA 5-9131

Shaw Avenue School

Principal's Office VA 5-9131

Nurse's Office VA 5-9131

Washington Avenue School

Office VA 5-9131

Stream Avenue School

Principal's Office VA 5-3044

Business Office VA 5-3044

Special Services

Elementary Consultant VA 5-9131

Guidance Consultant VA 5-9131

Psychologist VA 5-9131

Speech Consultant VA 5-9131

Reading Consultant VA 5-9131

Mathematics Consultant VA 5-9131

Audio-Visual Consultant LO 1-1165

Load School

Principal's Office PY 1-7676

Business Office PY 1-7676

INDEX

Board of Education and School Calendar see October

Shaw and Washington Avenue PTA see November

Clear Stream PTA see December

Forest Road PTA see January

Administration and Special Services see February

School Policies see March and April

The School Budget see May

Recommended Tours see June

Map of the District see July

Clear Stream and Forest Class Mothers see August

Shaw and Washington Class Mothers see facing page

CENTRAL HIGH SCHOOL DISTRICT NO. 1

Telephone Number: VA 5-8642

Use this number for all high school buildings, offices and personnel

NOTES

UNION FREE SCHOOL DISTRICT THIRTY
VALLEY STREAM, NEW YORK

30

SCHOOL ACTIVITIES

Calendar

FOR 1969-1970

PUBLISHED BY THE BOARD OF EDUCATION AND PARENT-TEACHER ASSOCIATIONS

TELEPHONE DIRECTORY

INDEX

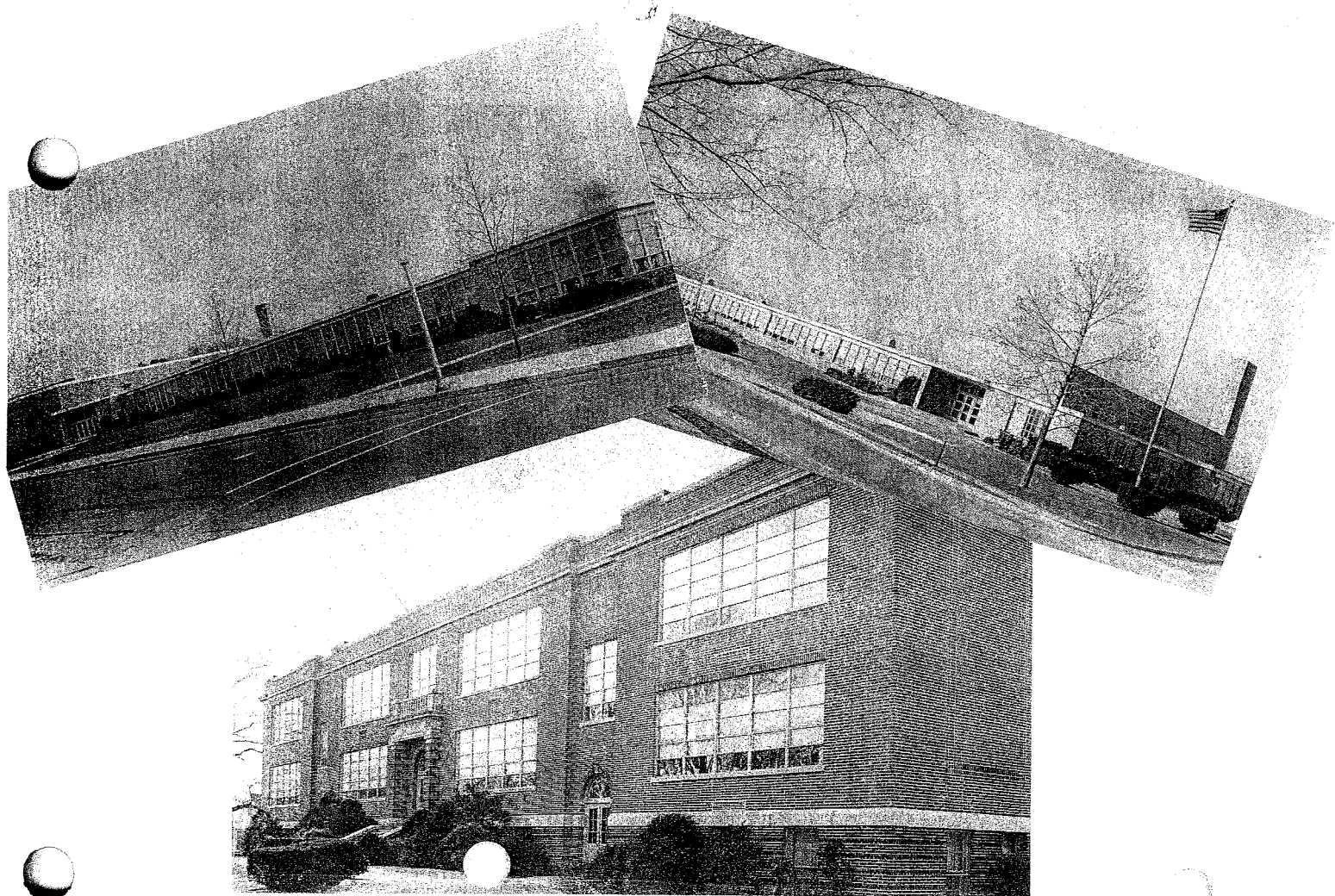

SEPTEMBER 1969

SUNDAY	MONDAY	TUESDAY	WEDNESDAY	THURSDAY	FRIDAY	SATURDAY
	1 LABOR DAY	2 FACULTY MEETING	3 SCHOOL OPENS <u>PTA Exec. Bd. Mtg.,</u> <u>Clear Stream, 8 p.m.</u>	4	5 <i>B.S. #368 - 4 p.m. 7:30 - 9:30</i>	6
7	8	9 C.H.S. Board Meeting 8 p.m.	10 PTA Exec. Bd. Mtg., Shaw, 8:30 p.m.	11	12 <i>Boys' Society 3:30 4 p.m. 7:30 - 9:30</i>	13 ROSH HASHANAH
14 ROSH HASHANAH	15	16	17 Parent's Night, Wash. Ave., 8:15 p.m. <u>PTA Gen. Meetings,</u> <u>Clear Stream, 8 p.m.,</u> <u>and Forest, 8:30 p.m.</u>	18	19 <i>B.S. #368 - 4 p.m. 7:30 - 9:30</i>	20
21	22 YOM KIPPUR SCHOOL CLOSED	23 District No. 30 Bd. of Ed. Meeting, 8:15 p.m.	24 Parent's Night Shaw (K-3) 8:15 p.m. <u>Clear Stream (K-1) 7:30</u> <u>and (2-3) 8:15 p.m.</u>	25 Parent's Night, Shaw (4-6) 8:15 p.m.	26 <i>B.S. #368 - 4 p.m. 7:30 - 9:30</i>	27 SUKKOT
28	29	30	<p><i>Do You Know . . .</i> . . . That more than 400 teachers apply to District Thirty for positions each year? . . . That 43% of the professional staff was at the Masters Degree level, or better this past school year?</p>			

BOARD OF EDUCATION



Standing (left to right): Eleanor Zeller, Board Clerk; Sherwood Quick, District Principal; George Adams, School Attorney; George Levine*; James R. Smith; Eleanor Berger, Board Treasurer. Seated: Elinor McAuliffe*, Vice-president; Robert Bell; Nathaniel Altschul*, President.

*Also serves on High School Board.

SCHOOL CALENDAR, 1969-1970

Meetings (School District conference)	Tues. Sept. 2	Christmas Recess	School closes at regular time	Tues. Dec. 23
.....	Tues. Sept. 2	Lincoln's Birthday	School Reopens	Mon. Jan. 5
Day of School	Wed. Sept. 3	Washington's Birthday	Thurs. Feb. 12
Appur	Mon. Sept. 22	Easter Recess	School closes at regular time	Mon. Feb. 23
as Day	Mon. Oct. 13	School Reopens	Wed. Mar. 25
' Day	Tues. Nov. 11	Passover	Mon. April 6
iving Recess	Schools close at end of morning session	Valley Stream Conference	Tues. & Wed. April 21 & 22
.....	Wed. Nov. 26	School closes for pupils
.....	Mon. Dec. 1	School closes for teachers

OCTOBER 1969

DAY	MONDAY	TUESDAY	WEDNESDAY	THURSDAY	FRIDAY	SATURDAY
Know ... at the District Thirty "concept" approach to the g of Social Studies has been in effect for fifteen Now it is advocated by the New York State Educa- partment for all the schools of the State.			PTA Exec. Bd. Mtgs., Shaw, 8:30 p.m. Clear Stream, 1:15 Forest, 8:30 p.m. Parent's Night, Clear Stream (4-5) 7:30 (6) 8:15 p.m.			
						4 Last Day of Sukkot Children's Theatre Central High 11 am.. "Pecos Bill"
5 Torah	Boy Scouts, P.M. A.P. Room	6 Basketball - Shaw, 7-9:30	8 PTA Workshop Clear Stream 1:15	9 4-6 P.P. Room 2:00-3:00	10 A.S. #362 - Shaw 7:30-9:30	11
12		13 V.S. Basketball 7-9:30 - Shaw A.S. #362 - Shaw 8-9:30	15 PTA Gen. Mtgs., Shaw, 8:15 p.m. Forest, 8:30 p.m.	16	17 Family Night at the Movies Clear Stream 7:30	18 PTA Carnival Forest Road
19 SCHOOL DAY	SCHOOL CLOSED	20 C.H.S. Bd. Mtg. 8 p.m.	22 Jelly apple & Pretzel Sale, Shaw 2:30-3:30 p.m. Pre-School Mtg. Clear Stream, 1:15	23	24 A.S. #362 - Shaw 7:30-9:30	25
26	27	28 Basketball Shaw, 7-9:30 A.S. #362 - Shaw 8-9:30	29	30	31 HALLOWE'EN	

SCHOOL ADMINISTRATION

Dr. William T. Callahan, *District Superintendent*

Sherwood S. Quick
District Principal

SCHOOL PRINCIPALS

CLEAR STREAM AVENUE SCHOOL
Richard M. Burbell

FOREST ROAD SCHOOL
Maurice E. St. Mary

SHAW AVENUE SCHOOL
Lawrence Cid

William J. Van Ness, *Administrative Assistant/Curriculum*
George W. Niederhauser, *Administrative Assistant/Business*

SCHOOL SECRETARIES

Jeanne Feeney, *Clear Stream Avenue*
Mary McDowell, *Forest Road*
Jean Annona, *Shaw Avenue*

DISTRICT SECRETARIAL STAFF

Margaret Bradley Lucy Felice Helen Kuchler
Marie O'Connell Marcella Pantaleo Mary Ribando
Edythe Sanchez Caroline Young
Evelyn Pearn, *Cafeteria Manager*

DISTRICT SPECIALISTS AND SPECIAL TEACHERS

Frank DeMarco, *Audio-Visual Consultant*
Rosalyn Kessler, *Psychologist*
Estelle Friedman, *Psychologist*
Raydine Teicheira, *Speech Consultant*
Frances Pollet, *Speech Teacher*
Agnes Mabry, *Reading Consultant*
Dolores Stein, *Foreign Language Consultant*
John Price, *Instrumental Music Teacher*
Margo Sokolow, *Instrumental Music Teacher*

OTHER SPECIALISTS AND SPECIAL TEACHERS

Clear Stream Avenue School
Cathleen Meneilly, *Special Counselor*
Janet Poppe, *Reading Specialist*
Grace Giacobone, *Art*
Philip Hessemer, *Physical Education*
Joan Henningsen, *Physical Education*
Linda Pratt, *Music*
Ruth Newman, *Librarian*
Edna Giebel, *Nurse-teacher*

Forest Road School
Wayne Clavering, *Special Counselor*
Rosemary Paradiso, *Reading Teacher*
Jean Ritzenthaler, *Art*
Alfred Stevens, *Physical Education*
Joan Henningsen, *Physical Education*
Frances Butler, *Music*
Rose Agree, *Librarian*
Hilda Rosenfeld, *Nurse-teacher*

Shaw Avenue School
Noel Giambalvo, *Special Counselor*
Jeanne Colton, *Reading Teacher*
Louise Holbrook, *Art*
Linda Sleiartin, *Art*
William Germann, *Physical Education*
Carol Gallof, *Physical Education*
Judith Howells, *Music*
Linda Tsuruoka, *Music*
Sylvia Berkowitz, *Librarian*
Dorothy McCutchan, *Nurse-teacher*

NOVEMBER 1969

DAY	MONDAY	TUESDAY	WEDNESDAY	THURSDAY	FRIDAY	SATURDAY
You Know That District Thirty was the only school district in Valley Stream to participate in the Metropolitan School Study Council Indicators of Quality research, a study of classroom techniques (1967 & 1969)? . . . That the New York State Education Department survey of the District Thirty schools of a few years ago rated them as of exceptionally high calibre? . . . That science as a course of study has been taught in the District Thirty schools for over thirty years?					1
2	3	4	5	6	7	8
		<i>Carb. Com. Cafe (2:30) 8-10 P.M.</i> ELECTION DAY <i>V.S. Board Meeting, 8:00-9:00 P.M.</i> SCHOOL OPEN <i>8:30-4:30</i> Cake Sale, Forest Road	PTA Exec. Bd. Mtgs., Shaw & Forest 8:30 Clear Stream 8 p.m.		<i>B.S. #366, Dyma 7:30-9:30</i>	
9	10	11	12	13	14	15
	Bookmobile, Shaw	SCHOOL CLOSED VETERANS DAY C.H.S. Bd. Mtg. 8 p.m. Bookmobile & Movie, Shaw <u>Movie, Clear Stream.</u>	Bookmobile, Shaw		<i>B.S. #366, Dyma 7:30-9:30</i>	
16	17	18	19	20	21	22
		<i>V.S. Board Meeting Dyma 7-9:30 8:30-4:30</i> Pre-School Mtg. Forest, 3 p.m.	PTA Gen. Mtgs., Clear Stream 8 p.m. Forest 8:30 p.m.		<i>B.S. #366, Dyma 7:30-9:30</i>	
23	24	25	26	27	28	29
		<i>V.S. Board Meeting Dyma 7-9:30 8:30-4:30</i> Dist. No. 30	SCHOOL CLOSES		<i>B.S. #366, Dyma 7:30-9:30</i>	

CLEAR STREAM AVENUE PARENT TEACHER ASSOCIATION

ELECTED OFFICERS 1969-1970

President	Ruth Cornish	872-3020
Vice Presidents	Jeanette Ermler	VA 5-6368
	Pat Strobl	825-4640
	Thomas Strobl	825-4640
	Hilda Flynn	VA 5-6081
	Gloria Corradi	CU 5-5255
	Dolores O'Leary	VA 5-5943
	Marie Pascuzzi	VA 5-8401
	Josephine Balsano	CU 5-9700
	Marilyn Margolies	CU 5-8973
	Joy Roccanova	285-8860
	Edna Giebel	Faculty
	Lois Barry	CU 5-8654

COMMITTEE CHAIRMEN

Flyers	Joy Roccanova	285-8860
Annual	Frank DeMarco	Faculty
Arts	Lois Barry	CU 5-8654
	Lois Barry	CU 5-8654
	Ann Docar	CU 5-8914
	Dorothea Munson	LO 1-2547
	Jo Heckman	LO 1-6414
	Lillian Serpico	LO 1-0117
	Lorraine Schroeder	825-1102
Secretary and By Laws	Connie Deering	CU 5-6210
	Jeanette Ermler,	VA 5-6368
	Pat Strobl	825-4640
Community Relations	Kay Ciccone	LO 1-9207
	Joseph Barry	CU 5-8654
	Irene Wood	872-8627
	Grace Landon	825-3491
TEAMER		
Publication	Muriel Watterson	825-5478
Means: Chrm. & Movies	Gloria Gargiulo	825-4074
ing	Kay Schmidt	872-8692
Sale	Pat Strobl	825-4640
	Mary Ammann	825-6090
	Jenny Tretolo	LO 1-2527

Kindergarten Rep.	Elena Cirenza	CU 5-5671
1st Grade Rep.	Mary Tragner	CU 5-9502
2nd Grade Rep.	Margie McGovern	CU 5-9011
3rd Grade Rep.	Josephine Coyle	CU 5-7731
4th Grade Rep.	Ann Prisco	CU 5-5744
5th Grade Rep.	Pat Strobl	825-4640
6th Grade Rep.	JoPat Minerva	VA 5-7433

P.T.A. PROGRAM

Sept.	3	Executive Board Meeting
	17	General Meeting
	24	Parents' Night Grades K-3
Oct.	1	Executive Board Meeting; Parents' Night Grades 4-6
	4	Children's Night at Central High—Pecos Bill
	8	Workshop
	17	Family Night at the Movies
	22	Pre-School
	31	Halloween Party Grades 5 & 6
Nov.	5	Executive Board Meeting
	11	Children's Movie
	19	General Meeting
Dec.	3	Executive Board Meeting
	10	Workshop
	18	Holiday Assembly—Beauty & The Beast Puppet Show
Jan.	7	Executive Board Meeting
	21	General Meeting
	24	Children's Theatre at Central High—Conn. Yankee in King Arthur's Court
	28	Executive Board Meeting
Feb.	12	Children's Movie
	14	Children's Theatre at Central High—Ransom of Red Chief
	18	Workshop
Mar.	4	Executive Board Meeting
	11	Pre-School
	18	Father-Faculty Night
Apr.	1	Executive Board Meeting
	8	Workshop
	17	Father-Son & Daughter Night
	29	Cake Sale
May	6	Executive Board Meeting
	11	Children's Movie
	12	Teacher Recognition Luncheon
	20	General Meeting
June	3	Joint Board Meeting

D E C E M B E R 1 9 6 9

DAY	MONDAY	TUESDAY	WEDNESDAY	THURSDAY	FRIDAY	SATURDAY
	1	2 <i>Pre-School Mtg., Washington & Shaw 3-3:30 p.m.</i>	3 <i>PTA Exec. Bd. Mtgs., Shaw & Forest 8:30 Clear Stream 8</i>	4	5 <i>8:30-11:30, Shaw 7:30-9:30</i>	6 HANUKAH
7	8	9 <i>C.H.S. Bd. Mtg. 8 p.m.</i>	10 <i>PTA Workshop Clear Stream, 1:15</i>	11	12 <i>Holiday Assembly, Shaw</i>	13
14	15	16	17 <i>PTA Holiday Assembly Forest</i>	18 <i>PTA Holiday Assembly Clear Stream</i>	19	20
21	22	23 <i>SCHOOL CLOSURE AT REGULAR TIME Dist. No. 30 Bd. of Ed. Mtg., 8:15 p.m.</i>	24 SCHOOL CLOSED	25	26	27
28	29	30	31	CHRISTMAS DAY <i>Do You Know . . . That unlike most school custodial staffs, the District Thirty custodians do most of the building</i>		

SHAW AND WASHINGTON AVENUES PARENT TEACHER ASSOCIATION

ELECTED OFFICERS 1969-1970

resident	Stella Schlaeger	CU 5-7588
1st Vice President	Angela Carmosino	872-8259
2nd Vice President	Lillian Fayet	561-6973
Recording Secretary	Ida Ierardi	CU 5-6047
Financial Secretary	Margaret Sharkey	Faculty
Corresponding Secretary	Marie Cecere	VA 5-9406
Delegates to Council	Mary Horozan	CU 5-5706
	Betsy Pine	CU 5-5806
	Miriam Sweet	Faculty
1st President	Sylvia Guttenplan	CU 5-7010

COMMITTEE CHAIRMEN

Audio-Visual	John Giacalone	Faculty
Budget	Sylvia Guttenplan	CU 5-7010
Center	Fran Dickinson	CU 5-9496
	Susan Barnaby	Faculty
Cultural Arts	Arlene Wexner	825-0381
	Sylvia Guttenplan	CU 5-7010
Children's Theatre	Lila Markowitz	285-5009
	Betsy Pine	CU 5-5806
Distribution	Rita Dolan	CU 5-6008
Grade Rep. Coordinator	Marie DiGiamo	LO 1-0079
Historian	Grace Pisano	872-3097
Health and Safety	Dee Robson	825-0598
Hospitality	Marie Cecere	VA 5-9406
Legislation	Julia Score	LO 1-0120
Membership	George Schlaeger	285-7588
	Jean Davis	872-3938
	Dee Robson	825-0598
Mental Health & Except. Child	Angela Carmosino	872-8259
Micrograph	Miriam Balaban	CU 5-8191
Newsletter	Lillian Fayet	561-6973
Parent Education	Sylvia Guttenplan	CU 5-7010
Parliamentarian	Harriet Kraft	Faculty
Pre-School	Sylvia Guttenplan	CU 5-7010
	Vita Capossela	285-6160
Program	Judith Blessinger	Faculty
Publications	Angela Carmosino	872-8259
School Board Rep.	Lillian Rukasin	285-7679
Screening	George Schlaeger	CU 5-7588
	Lila Markowitz	285-5009
Days and Means	Ida Ierardi	CU 5-6047
Apple & Pretzel	Lillian Fayet	561-6973
Mobile	Sylvia Guttenplan	CU 5-7010
	Jean Davis	872-3938

Fashion Show

Fashions	Angela Carmosino	872-8259
Refreshments	Marie Cecere	VA 5-9406
Raffles	Lois Plawsky	VA 5-4061
Decorations	Ida Ierardi	CU 5-6047
Tickets	Mary Horozan	CU 5-5706
Kindergarten Rep.	Anita Filosa	LO 1-0074
1st Grade Rep.	Lois Plawsky	VA 5-4061
2nd Grade Rep.	Lillian Ging	CU 5-6072
3rd Grade Rep.	Maureen Pascale	825-0303
4th Grade Rep.	Dee Robson	825-0598
5th Grade Rep.	Sylvia Guttenplan	CU 5-7010
6th Grade Rep.	Jean Layden	285-7624

P.T.A. PROGRAM

Sept. 10	Executive Board Meeting — 8:30 p.m.
17	Parent's Night — Washington Ave. — 8:15 p.m.
24	Parent's Night — Shaw Ave. — K to 3: 8:15 p.m.
25	Parent's Night — Shaw Ave. — 4 to 6: 8:15 p.m.
Oct. 1	Executive Board Meeting — 8:30 p.m.
3	Cultural Arts Assembly
15	General Meeting — 8:15 p.m. (Parent Education)
22	Jelly Apple & Pretzel Sale — 2:30 to 3:30 p.m.
Nov. 5	Executive Board Meeting — 8:30 p.m.
10	Bookmobile
11	Bookmobile & Movie
12	Bookmobile
Dec. 2	Pre-School Meeting — Washington Ave. & Shaw Ave. 3:00 to 3:30 p.m.
3	Executive Board Meeting — 8:30 p.m.
12	Holiday Assembly for Children
Jan. 7	Executive Board Meeting — 8:30 p.m.
14	General Meeting — Afternoon (Mental Health)
20	Pre-School Meeting — Washington Ave. & Shaw Ave. 3:00 to 3:30 p.m.
Feb. 4	General Meeting — Founder's Day — Shaw — 8:15 p.m.
Mar. 4	Executive Board Meeting — 8:30 p.m.
10	Pre-School Meeting — Washington Ave. & Shaw Ave. 3:00 to 3:45 p.m.
11	Fashion Show
18	General Meeting — Afternoon (Narcotics)
April 8	Executive Board Meeting — 8:30 p.m.
11	Movie
14	Parent Ed. Meeting — Shaw — Mothers — 1:00 p.m.
16	Parent Ed. Meeting — Shaw — 5th Grade Girls — 3:00 p.m.
17	Parent Ed. Meeting — Shaw — 6th Grade Girls — 3:00 p.m.
23	Parent Ed. Meeting — Shaw — Fathers & 6th Grade Boys — 8:00 p.m.
May 6	Executive Board Meeting — 8:30 p.m.
12	Teacher Recognition Day — Luncheon — Shaw
20	General Meeting — Installation Night — Shaw — 8:15 p.m.
June 3	Joint Executive Board Meeting — Afternoon
6	Movie

JANUARY 1970

DAY	MONDAY	TUESDAY	WEDNESDAY	THURSDAY	FRIDAY	SATURDAY
	<p><i>Do You Know . . .</i> . . . That the third grades of District Thirty scored as one of the highest in the county on the Educational Council Mathematics Test (1968)? . . . That District Thirty was one of the first elementary school districts on Long Island to have a foreign language program (French)?</p>			1	2	3
	4	5	6	7	8	9
	11	12	13	14	15	16
	18	19	20	21	22	23
	25	26	27	28	29	30
						31

FOREST ROAD PARENT TEACHER ASSOCIATION

ELECTED OFFICERS 1969-1970

President	Mrs. Eleanor Klein	PY 1-3060
First Vice President	Mrs. Ruth Weinstein	PY 1-9045
Second Vice President	Mrs. Lillian Spector	PY 1-2627
Third Vice President	Mrs. Len Wolff	PY 1-8391
Treasurer	Mrs. Marcia Chaiet	PY 1-2641
Financial Secretary	Mrs. Phyllis Wolin	PY 1-8120
Corresponding Secretary	Mrs. Gertrude Myron	PY 1-2386
Recording Secretary	Mrs. Marjorie Grauer	PY 1-6043
Delegate to Council		

COMMITTEE CHAIRMEN

Budget	Marcia Chaiet	PY 1-2641
Class Mother	Marcia Balaban	PY 1-7598
Class Mother	Ruth Misrok	PY 1-2597
Family Living (Mental Health)	Nancy Cesta	PY 1-8028
Flyers	Carol Provenzano	
	Dottie Singer	PY 1-9631
	Esther Behar	
Goodwill	Frieda Markinson	PY 1-2715
Hospitality	Evelyn Levy	PY 1-2651
Historian	Charlotte Hellreich	PY 1-4093
Health & Safety	Emma Breman	PY 1-5070
Legislation	Anita Miller	PY 1-7782
Library & Book Fair	Debbie Zarchy	PY 1-7039
	Doris Bernanke	PY 1-3790
Membership	Roslyn Eisenberg	PY 1-3246
Mimeograph	Pearl Lustbader	PY 1-9547
Music & Art	Corky Shaw	PY 1-8807
	Susan Yarrin	PY 1-2999
Newsletter	Ann Berger	PY 1-4088
	Gloria Massone	LO 1-7764
Parliamentarian	Larry Misrok	PY 1-2597
Posters	Francine Eisenstadt	PY 1-4840
Pre-School	Renee Pepper	PY 1-3857
Publications	Selma Singer	PY 1-3592
Publicity	Carol Andiman	PY 1-4686
	Roslyn Drexler	PY 1-2709
School & Comm. Relations	Marlyn Fogel	PY 1-4701
	Diane Kahn	PY 1-4756
School Bd. Rep. - Elem.	Marjorie Graver	PY 1-6043
	Ruth Weinstein	PY 1-9045
School Bd. Rep. - H.S.	Phyllis Abelov	PY 1-7951
Teacher Rep.	Judy Post	PY 1-7676
Typist	Madeline Margulies	PY 1-5097
	Alberta Schechtman	PY 1-3471
Ways & Means	Marie D'Alessandro	1-4194
	Olga Noto	1-2310
	Barbara O'Reilly	PY 1-4068

P.T.A. PROGRAM

Sept.	17	PTA General Meeting — "Meet the Teacher Night"
Oct.	1	PTA Executive Board Meeting — 8:30 p.m.
	15	PTA General Meeting — 8:30 p.m.
	18	PTA Carnival
Nov.	4	PTA Cake Sale
	5	PTA Executive Board Meeting — 8:30 p.m.
	18	Pre-School Meeting — "Let's Get Acquainted" — 3:00 p.m.
	19	PTA General Meeting — 8:30 p.m.
Dec.	3	PTA Executive Board Meeting — 8:30 p.m.
	10	Pre-School Meeting — "Fun With Art" — 2:00 p.m. — Part I
	17	PTA Holiday Assembly Gift to Children
Jan.	7	PTA Executive Board Meeting — 1:00 p.m.
	14	Pre-School Meeting — "Fun With Art" — 2:00 p.m. — Part II
	21	PTA Workshop — 1:00 p.m.
Feb.	2	Valley Stream PTA Council Meeting — Forest Road — 8:30 p.m.
	4	PTA Founder's Day Meeting — Shaw Avenue School — 8:15 p.m.
	17	Pre-School Meeting — "Let's Make Music" — 3:00 p.m.
	24	PTA Executive Board Meeting — 1:00 p.m.
March	4	PTA Executive Board Meeting — 8:30 p.m.
	17	Pre-School Meeting — "Let's Have Fun" — 3:00 p.m.
	18	PTA General Meeting — 8:30 p.m.
April	8	Pre-School Meeting — "Tell Me a Story" — 2:00 p.m.
		PTA Executive Board Meeting — 8:30 p.m.
	13	Sex Hygiene Meeting — 6th grade parents — 8:30 p.m.
	14	Sex Hygiene Meeting — 6th grade girls — 2:45 p.m.
	15	Sex Hygiene Meeting — 5th grade girls — 2:45 p.m.
	16	Sex Hygiene Meeting — 6th grade boys — 8:00 p.m.
	29	PTA General Meeting — 1:00 p.m.
May	6	PTA Executive Board Meeting — 8:30 p.m.
	13	Teacher Recognition Day Luncheon — 11:30 to 1:00 p.m.
	20	PTA General Meeting — Installation of Officers — 8:30 p.m.
June	3	PTA Joint Boards Meeting — 8:30 p.m.

FEBRUARY 1970

SUNDAY	MONDAY	TUESDAY	WEDNESDAY	THURSDAY	FRIDAY	SATURDAY
1	2 V.S. PTA Coun. Mtg. Forest	3 <i>U.S. Basketball 7-9:30</i>	4 PTA Founder's Day Mtg. Shaw, 8:15 p.m. PTA Exec. Bd Mtg. Forest, 1:00 p.m.	5	6 <i>B.S. Bd. Mtg. 7:30-9:30</i>	7
8	9	10 <i>U.S. Basketball 7-9:30</i> C.H.S. Bd. Mtg. 8 p.m.	11	12 LINCOLN'S BIRTHDAY SCHOOL CLOSED <u>Children's Movie</u> <u>Clear Stream</u>	13 <i>B.S. Bd. Mtg. 7:30-9:30</i>	14 Children's Theatre 11 a.m. Cent. High "Ransom of Red Chief"
15	16	17 <i>U.S. Basketball 7-9:30</i> Pre-School Mtg., 3 p.m. "Let's Make Music"	18	19	20 <i>B.S. Bd. Mtg. 7:30-9:30</i>	21
22	23	24 <i>U.S. Basketball 7-9:30</i> Dist. No. 30 Bd. of Ed. Mtg. 8:15 p.m.	25	26	27 <i>B.S. Bd. Mtg. 7:30-9:30</i>	28
29 WINGTON'S THDAY	30 SCHOOL CLOSED					

Do You Know . . .
 . . . That the administrators in the District Thirty schools work as a team — supervising instruction in all four buildings?
 . . . That more than thirty articles written by District Thirty personnel have been published in professional journals in the past fifteen years?
 . . . That more than ten sets of flouting authored by District Thirty . . .

SOME PARENT'S QUESTIONS ANSWERED

Here are a few questions constantly asked by many parents which we feel can be answered on this page of your Activity Calendar.

QUESTION: "Is there a shortage of Social Studies and Science textbooks for the pupils?"

ANSWER: No. Both of these subjects are taught using a variety of approaches. There is no one textbook for either subject. Rather than a single textbook we use a few copies of several different textbooks (about ten to twelve copies of each of several different series), so thus in each of these subjects there can be as many as sixty to eighty textbooks. In this way, youngsters are taught to use different resources for answers to questions as well as to make comparisons of authors' viewpoints. In addition, the pupils often work in small committees doing research and thus are learning how to get along with each other. They also make reports of their findings to the rest of the class so they are learning the skills necessary for good communication.

QUESTION: "How are children placed in the next year's classes?"

ANSWER: District Thirty has what is called "planned heterogeneity." Each June the teachers are issued promotion forms and planning groups for the next year's classes. Prime consideration is given to form groups which are a cross-section of all ages of pupils—balanced as nearly as possible in all respects. The teachers of a grade-level, using the promotion forms, meet to assign youngsters to groups labeling them A, B, C, and so on, thus assuring that all groups are as equal as we can make them. The building principals then assign the groups to teachers. You can rest assured that very careful thought goes into all this procedure.

QUESTION: "What procedure should I follow when dealing with my child's school problem?"

ANSWER: Dealing with your child's classroom problems is simple, direct and satisfying if you will follow this procedure:

1. First, have a conference with the teacher. This is best arranged by telephoning in advance for an appointment; in this way you are sure of having the teacher available.

During the conference, you and the teacher should explore all aspects of the problem or question that has arisen, and understand fully the measures to be taken by the school, the home, or school and home jointly.

2. If a satisfactory solution cannot be found, then take the problem to the principal. Again, a telephone call first will assure you of his availability. During the course of your meeting with him, he may or may not ask the teacher to join the conference, and, on rare occasions, your child, too.

There are two *don'ts* to observe:

1. Don't make your first contact with the principal. After all, it is the teacher who is in constant direct contact with your child and who is in the most strategic position to work out a solution with you. So see the teacher first, and then, if necessary, see the principal.

2. Don't call the PTA. The PTA is a semi-official adjunct of the school, but it has no connection with the teaching or administrative operations of the school.

Usually, your conference with the teacher will solve your problem, or at least get things underway. Please remember that some situations take time to change; in some cases there is no instant solution.

There is one category of problems which you should take directly to the principal; those which are not classroom problems. In such instances, there is no need to see the teacher first.

Remember: The first concern of the school is your child. Now, as in the past, school personnel are always available to you. There is no problem that cannot be solved when the school and the home work together in the best long-range interest of the child. The doors are always open to you in these, your Friendly Schools.

MARCH 1970

SUNDAY	MONDAY	TUESDAY	WEDNESDAY	THURSDAY	FRIDAY	SATURDAY
1	2	3 <i>Book Loan</i> <i>8-10</i> <i>Mr. Baskin</i> <i>7-9:30</i>	4 PTA Gen. Mtg., Shaw, & Forest, 8:30 p.m. Clear Stream, 8	5	6 <i>Dist. Bd. Mtg.</i> <i>7:00-9:00</i>	7
8	9	10 C.H.S. Bd. Mtg. 8:15 p.m. Pre-School Mtg. Wash. & Shaw, 3-3:45 p.m.	11 PTA Fashion Show, Shaw Pre-School Mtg., Clear Stream, 7:15 p.m.	12	13 <i>Dist. Bd. Mtg.</i> <i>7:30-9:00</i>	14
15	16	17 <i>Mr. Baskin</i> <i>7-9:30</i> Pre-School Mtg. Forest, 3 p.m., "Let's Have Fun"	18 PTA Gen. Mtgs., Shaw, afternoon Forest, 8:30 p.m. Father-Faculty Night, Clear Stream, 8 p.m.	19	20 <i>Dist. Bd. Mtg.</i> <i>7-9:00</i>	21
22	23	24 <i>Mr. Baskin</i> <i>7-9:30</i> Dist. No. 30 Bd. of Ed. Mtg., 8:15 p.m.	25 SCHOOL CLOSES AT REGULAR TIMES	26	27 Good Friday SCHOOL CLOSED	28
29	30	31	Do You Know That the District Thirty Pre-School Packet has received national recognition many times and requests for copies have come from as far away as Hawaii and Puerto Rico?			

WHY WE NEED MORE STATE AID

One does not have to read in the newspaper that the cost of living is going up and up. He sees daily, when he goes to the supermarket, how little he can buy for \$10.00. The New York metropolitan area is one of the highest cost-of-living areas in the country, and this fact makes budgeting for school purposes comparatively more difficult here than in other areas of the State.

Add to the higher costs the action of the New York State legislature in its recent session—the cutting back of state aid—and you have the dilemma faced by your local Board of Education. How can the Board continue to provide the quality education for which the district has been known, and still keep costs within reasonable bounds?

To answer this question, the Board of Education spends many, many hours deliberating on each aspect of the budget, and it is only after long time and thought that it formulates what it considers an adequate financial program for the following year.

Despite all its efforts and time, the Board is limited by certain laws and mandates from the State of New York. For example, laws require local school districts to pay more and more towards transportation of pupils to private and parochial schools, transportation and tuition for handicapped pupils, and for teacher retirement and other fringe benefits. The Board has nothing to say about such increases; they are required by law to comply.

What can you do about the higher school budgets? Our only advice is to continue to press your state legislators to increase, rather than decrease, state aid to local school districts. After all, over 85% of the school budget is allocated to salaries, retirement and other mandated items. If every taxpayer in District Thirty were to make his feelings known to his local legislators, this should help bring about the desired effect: to have the State assume more of the costs of education.

We urge all of you to keep aware of what the State legislature does each year. Your local Parent-Teacher Associations keep well abreast of these matters and can inform you. In addition, very adequate coverage of legislative actions is in your local newspapers.

You can rest assured that the Board of Education will continue to give careful consideration to this year's budget and to future budgets, and that it is extremely grateful for the local support given it by the taxpayers of District Thirty.

APRIL 1970

DAY	MONDAY	TUESDAY	WEDNESDAY	THURSDAY	FRIDAY	SATURDAY
			1	2	3	4
	<i>You Know . . .</i> That the use of television as an educational aid in District Thirty fifteen years ago? That District Thirty was one of the first school districts on Long Island to teach modern mathematics?		SCHOOL CLOSED	SCHOOL CLOSED	SCHOOL CLOSED	
5	6	7	8	9	10	11
	SCHOOL REOPENS	<i>Bob. Conn. Cafe 8-10</i> <i>M.</i>	PTA Gen Mtg. Shaw, 8:30 p.m. PTA Exec. Bd. Mtgs., Clear Stream, 8 p.m. Forest 8:30 p.m.		<i>B.S.#368, Shaw 7:30-9:30</i>	PTA Movie, Shaw
12	13	14	15	16	17	18
	Sex Hygiene Mtg. 6th Gr. Parents Forest, 8:30 p.m.	C.H.S. Bd. Mtg. 8 p.m. Parent Ed. Mtg., Shaw Mothers, 1 p.m. Sex Hygiene Mtg. 6th Gr. Girls, 2:45	PTA Workshop, Clear Stream, 1:15 Sex Hygiene Mtg., 5th Gr. Girls, Forest, 2:45 p.m.	Parent Ed. Mtg. Shaw, 5th Gr. Girls, 3 p.m. Sex Hygiene Mtg., 6th Gr. Boys, Forest, 8 p.m.	<i>B.S.#368, Shaw 7:30-9:30</i> Parent Ed. Mtg., Shaw, 6th Gr. Girls, 3 p.m. PTA Father-Son-Daugh. Night, Clear Stream, 7:30 p.m.	
19	20	21	22	23	24	25
	PASSOVER SCHOOL CLOSED	PASSOVER SCHOOL CLOSED	PASSOVER SCHOOL CLOSED	Parent Ed. Mtg. Shaw, Fathers, 6th Gr. Boys, 8 p.m.	<i>B.S.#368, Shaw 7:30-9:30</i> Reg. for next year's Kindergarten, each school 9-11 a.m.	Reg. for school voting, 7 a.m. to 12 noon, each school
26	27	28	29	30		
		CONCLUSION OF PASSOVER Dist. No. 20	PTA Cake Sale, Clear Stream	Reg. for school voting.	<i>Do You Know . . .</i> . . . That District Thirty was one of the few school districts on Long Island to have a mathematics con-	

SCHOOL POLICIES

SCHOOL HOURS

Hours for grades 1, 2, and 3 are from 9:00 a.m. to 3:00 p.m.
 Hours for grades 4, 5, and 6 are from 8:30 a.m. to 2:45 p.m.

LUNCH

Lunch is served beginning with the first day of school. Pupils who do not come home for lunch, bring lunch from home, or buy the school lunch in the cafeteria for 35c. Monthly menus are provided so that all pupils are served which your child does not eat, you can make other provisions for him for those days. In case a child forgets his lunch money or his lunch, or loses either, we have a loan system to cover the emergency. The cashier in the cafeteria keeps the record of such charges and contacts the parents if a charge not be paid in a reasonable time.

ICE CREAM

Ice cream is sold daily to those pupils who wish it. It is not sold with the hot lunch and costs an additional 10c.

RECESS MILK

Recess milk is available to all children beginning about the middle of the school year and is sold at a cost of 15c per week each Thursday for the following week. You will be notified as to the exact date. Money brought in late (Friday) cannot be accepted. In case of a child's absence, no refund is made for periods of less than a full week.

ABSENCES

If your child has been absent, State law requires that he bring a note from you explaining the absences and the date(s) of absence(s). The note should be presented to the nurse before coming to the classroom. Please be specific. Just saying, "he was sick" is not enough. Indicate whether it was "virus," "fever," "flu," etc. A note is required for an absence due to a religious holiday. A note is required for any tardiness, giving the reason. If your child contracts a contagious disease, such as mumps, measles, etc., please phone the school nurse so that she can notify the parents in your child's class that their children have been exposed. Be sure to keep the emergency card up to date and that all know whom to call should your child become ill and you have to go home.

NOON HOUR RULES

When pupils misbehave in the cafeteria, auditorium, or on the playground during the noon hour, after repeated reminders, the teachers have the authority to exclude them from staying in school for lunch for a few days, or longer, depending on the misbehavior. If you receive such a note from us, we would appreciate your cooperation. Whether or not a mother is home during the noon hour has no bearing on this exclusion.

RELEASED TIME FOR RELIGIOUS INSTRUCTION

A Release Form signed by the parent is necessary should you want your child excused from school for religious instruction. Such forms can be obtained from your church. The time provided is the last hour of school on Wednesday afternoons.

EXITS AND ENTRANCES

Your child's class is assigned a specific exit and entrance to use. You will thus know where to meet him if you come to pick him up. Parents picking up children are asked to meet them at the exit, not the classroom.

ENTRANCE TIMES

Morning — All Schools	Noontime — Shaw & Forest
Grades 1, 2, & 3 — 8:50	Grades 1, 2, & 3 — 12:50
Grades 4, 5, & 6 — 8:20	Grades 4, 5, & 6 — 12:20
Noontime — Clear Stream: Grades 5 & 6 — 12:05	
Grades 3 & 4 — 12:35; Grades 1 & 2 — 1:05	

Because there is no supervision of the playground in the morning, we suggest you arrange your child's departure from home to allow him to arrive just in time to enter the building during the proper interval. In inclement weather he may come into the designated area five minutes before the above times.

CLASS INTERRUPTIONS

No unnecessary interruptions of classes are allowed once the day's sessions have begun. When your child forgets a book, homework, sneakers, lunch money, etc., please bring these to the office. All pupils are instructed to check with the office at lunch time for such forgotten items. In the interest of the child's all-round education, we urge you not to make a practice of bringing forgotten items to school. The child should be developing his own sense of responsibility for these things.

MAY 1970

DAY	MONDAY	TUESDAY	WEDNESDAY	THURSDAY	FRIDAY	SATURDAY	
<i>You Know...</i> That Board of Education members serve without pay? That Dr. Robert Bell has been a member of the Board of Education for twenty years? That the Board of Education receives frequent compliments on the excellent upkeep of school grounds? That three members of the District Thirty Board of Education are also members, of Central School Board of Education?					BS #368, Dym 7:30 - 9:30	2	
3	4	C.H.S. Bd. Mtg. 2:30 Cafeteria 2-10 M. 3-4:30	5	6	7	8	9
			Voting on school bud., 7 a.m. to 10 p.m. PTA Exec. Bd. Mtgs., Shaw & Forest, 8:30, Clear Stream, 1:15 p.m.			BS #368, Dym 7:30 - 9:30	
10	11	12	13	14	15	16	
Teachers' Conference SCHOOL CLOSED Children's Movie, Clear Stream		C.H.S. Bd. Mtg., 8 p.m. Teacher Recognition Day Luncheon, Shaw & Clear Stream	Teacher Recognition Day Luncheon, Forest, 11:30 to 1:00 p.m.				
17	18	19	20	21	22	23	
			PTA Gen. Mtgs., Shaw, 8:15 p.m. Clear Stream, 8 p.m.		BS #368, Dym 7:30 - 9:30		
24	25	26	27	28	29	30	
					BS #368, Dym 7:30 - 9:30		
31	Reg. for next year's	Dist. No. 30					

SCHOOL POLICIES

GYM SUITS AND SNEAKERS

Gym suits are required of pupils below the 3rd grade, but sneakers are necessary for any pupils using the gym. Boys and girls from the 3rd through 6th grades are required to wear gym suits and sneakers on the assigned gym days. The gym teachers explain this to the pupils, but many times they do not bring correct information home.

Who MUST PURCHASE A NEW SUIT should buy the same ROYAL BLUE, bloomer type, with elastic bottoms, or ROYAL BLUE shorts with elastic insert in the cuff, and a white shirt. Boys should wear ROYAL BLUE shorts, with elastic top, sneakers (high top ones preferred), and white or SCHOOL "T"

IF A CHILD HAS ANOTHER COLOR, OR TYPE, HE DOES NOT NEED TO BUY A NEW ONE. The above apparel may be purchased at many local stores in Valley Stream. NO ONE IS ALLOWED ON THE GYM FLOOR WITHOUT SNEAKERS.

APPOINTMENTS WITH TEACHERS

In order that pupils' classtime be used to the fullest advantage, we request that parents do not seek conferences with teachers during school hours. If you wish a conference, please make an appointment to see the teacher after school. Teachers are available for such conferences every day except Mondays and Fridays.

BICYCLES

Bicycles are allowed at either Forest Road or Clear Stream Elementary Schools because no child lives far enough from the school to make them necessary. They are allowed at Shaw, but are restricted to pupils in grades 4, 5, and 6 who live NORTH OF CLEAR AVENUE. Bicycles used to come to the Shaw Avenue school will be assigned a number. All must have a lock and helmet for safety purposes.

GIFTS TO TEACHERS PROHIBITED

The policy of the school district which became effective January 1, 1956, is to prohibit the acceptance of gifts by faculty members on school premises, and to prohibit the solicitation of funds for personal gifts purposes, by any person, or persons, on the premises.

IN-DAY PROGRAM

In inclement weather, there is an in-day program of motion pictures provided for those pupils who eat in the cafeteria. Pupils who go home to lunch are not allowed to participate in this program because of space limitations, so we ask parents to return these pupils to school on such days just in time for the afternoon session—not before 12:50 p.m. for grades 1 to 3, and 12:20 p.m. for grades 4 to 6 at Shaw and Forest; and not before 12:05 for grades 5 and 6, 12:35 for grades 3 and 4, and 1:05 for grades 1 and 2 at Clear Stream.

HOMEWORK REQUIREMENTS

Homework is required of all pupils, but it will vary from day to day. First and second grade pupils may have fifteen to twenty minutes of homework per day, while third and fourth grade pupils are likely to have thirty to forty minutes. Fifth and sixth graders are expected to devote as much as an hour to homework, but again this may not be every day—it will depend on the pupil and his needs.

LOST AND FOUND

Unmarked articles lost by pupils are placed in the Lost-and-Found, which is in the Nurse's Office. Such articles, if not claimed at the end of the school year, are given to a charitable organization. However, any articles bearing a child's name is returned directly to him. Please place your child's name on all his belongings.

STAYING AFTER SCHOOL

To eliminate any confusion or problems, the school may have your child every day for an additional half hour. During this half hour beyond the regular school day, the teacher may schedule your child for special help or keep him for any of several reasons. We ask that you keep this in mind and not schedule dental appointments, dancing lessons, etc. until after that interval. Teachers are also available to parents during the half hour after school, except on Monday and Friday, for conferences. Appointments are not necessary, but it is to your advantage to make one, so that you can be sure of the teacher's availability.

ASSEMBLIES

When your child's class puts on the assembly, we welcome your attendance, but we do ask you not to bring pre-school children. As much as we realize that it is a thrill for them to see a big brother perform, they are often distracting to a child concerned.

JUNE 1970

DAY	MONDAY	TUESDAY	WEDNESDAY	THURSDAY	FRIDAY	SATURDAY
	1	2	3	4	5	6
			PTA Joint Exec. Bd. Mtgs., Shaw, after noon, Clear Stream, 8 p.m. & Forest, 8:30 p.m.			PTA Movie, Shaw
7	8	9	10	11	12	13
		C.H.S. Bd. Mtg. 8 p.m.	Shavout	Shavout		
14	15	16	17	18	19	20
DAY			CLOSING EXERCISES		LAST DAY OF SCHOOL	
21	22	23	24	25	26	27
TEACHER'S DAY	ANNUAL SCHOOL CENSUS BEGINS	Dist. No. 30 Bd. of Ed. Mtg., 8:15 p.m.				
28	29	30	Do You Know That an average of over 400 youngsters enjoy the District Thirty Summer Recreation Program on any given day? . . . That over 500 library books were loaned to youngsters during the Summer Library Program of 1968?			
	SUMMER RECREATION PROGRAM BEGINS					

SHAW AND WASHINGTON AVENUE SCHOOLS

CLASS MOTHER LIST

Grade Representative Coordinator Marie DiGiamo, LO 1-0079

Class Mother	Tel. Number	Teacher	Gr.	Room	Class Mother	Tel. Number	Teacher
ergarten Representative	Anita Filosa, LO 1-0074				4th Grade Representative	Dee Robson, 825-0598	
1 Mrs. Calamusa	CU 5-4992	Miss Corin	4	106	Mrs. Napolitano	CU 5-6002	Mrs. Stiefel
1 Mrs. Ging	CU 5-6072	Miss Corin	4	108	Mrs. Goldfischer	CU 5-6227	Mrs. Benedetto
1 Mrs. Yocono	VA 5-0728	Miss Starlar	4	109	Mrs. Knechtel	CU 5-5786	Mrs. Barnaby
1 Mrs. Kelly	825-0113	Miss Blessinger	4	110	Mrs. Davis	872-3938	Mr. Riccobono
1 Mrs. LoPiccolo	LO 1-1045	Miss Blessinger					
Grade Representative	Lois Plawsky, VA 5-4061				5th Grade Representative	Sylvia Guttenplan, CU 5-7010	
Mrs. Cohen	VA 5-4381	Mrs. Levine	5	114	Mrs. Ierardi	CU 5-6047	Mrs. Wasserman
Mrs. Hunt	872-3963	Miss Davis	5	116	Mrs. DiLuccio	LO 1-6837	Miss Schwartz
Mrs. Kiel	CU 5-9651	Mrs. Kraft	5	117	Mrs. Dickinson	CU 5-9496	Mr. Beyer
Mrs. Muro	CU 5-9781	Miss Arnone	5	118	Mrs. Thomas	825-2479	Mrs. Hamcke
Grade Representative	Lillian Ging CU 5-6072		5	122	Mrs. Short	825-5019	Mrs. Kaplan
Mrs. Daniello	VA 5-6004	Mrs. Eichlin			6th Grade Representative	Jean Layden, 285-7624	
Mrs. Kurkjian	825-5701	Miss Bellini	6	121	Mrs. Horozan	CU 5-5706	Mrs. Squires
Mrs. Nickdow	285-4869	Miss Cohen	6	123	Mrs. Goldfischer	CU 5-6227	Miss Lanell
Mrs. Kelly	825-0113	Mrs. Colletti	6	124	Mrs. Monachino	VA 5-1218	Mrs. Sherman
Grade Representative	Maureen Pascale, 825-0303		6	125	Mrs. Short	825-5019	Mrs. Rosche
Mrs. Pena	825-0887	Mrs. Sweet	6	127	Mrs. Fayet	561-6973	Mr. Giacalone
Mrs. Rukasin	CU 5-7679	Mrs. Strumpf	Special				
Mrs. DiGiamo	LO 1-0079	Mrs. Stevens	Cl. 131		Mrs. Cooper	825-7779	Mrs. Krimko
Mrs. Field	VA 5-8581	Miss Sharkey					

JULY 1970

SUNDAY	MONDAY	TUESDAY	WEDNESDAY	THURSDAY	FRIDAY	SATURDAY
			1	2	3	4
<p><i>Know . . .</i> the main office at Shaw Avenue School is open every day during the summer and at least one administrator is present at all times? As much paper work as possible is done in the summer months so that during the school year we can concentrate on improvement of instruction?</p>						INDEPENDENCE DAY
5	6	7	8	9	10	11
		Dist. 30 Reorganization Meeting				
12	13	14	15	16	17	18
		C.H.S. Bd. Mtg., 8:00 p.m.				
19	20	21	22	23	24	25
26	27	28	29	30	31	
		Dist. No. 30 Bd. of Ed. Mtg., 8:15 p.m.				

CLEAR STREAM AVENUE SCHOOL

CLASS MOTHER LIST

le	Room	Class Mother	Tel. Number	Teacher
(8:30)		Joan Bastone	CU 5-5040	Miss Starler
(8:30)		Marie Cusumano	VA 5-4956	Miss Starler
(11:00)		Claire DiNapoli	CU 5-6275	Miss Eden
(11:00)		Marilyn Wheeler	285-9645	Miss Eden
(1:30)		Marilyn Palazzo	872-3372	Miss Eden
(1:30)		Jean Savarese	285-5116	Miss Eden
8		Norma Rodriquez	LO 1-1382	Mrs. Riccobono
8		Irene Wood	285-9125	Mrs. Riccobono
7		Marie Cusumano	VA 5-4956	Mrs. Lauria
7		Theresa Fileccia	LO 1-0938	Mrs. Lauria
B		Carol-Ann Heller	LO 1-9610	Mrs. Schaaf
B		Rose La Russo	872-8079	Mrs. Schaaf
2		Ann Prisco	CU 5-5744	Mrs. Guberman
2		Betsy Mulato	CU 5-6048	Mrs. Guberman
5		Mary Ammann	CU 5-6090	Mrs. Williams
5		Shirley Fifield	285-9081	Mrs. Williams
6		Marion Acquavella	VA 5-2272	Miss Patterson
6		Virginia Locke	CU 5-9730	Miss Patterson
3		Marie Pascuzzi	VA 5-8401	Miss Rose
3		Barbara Passaro	825-1608	Miss Rose
1		Muriel Watterson	825-5478	Miss Firpo
1		Carol Shortell	CU 5-7809	Miss Firpo
4		Rosalie Cuillo	LO 1-1925	Miss Schindelman
4		Dorothy Munson	LO 1-2547	Miss Schindelman
23		Joy Rocanova	285-8860	Miss Galbraith
23		Jennie Tretolo	LO 1-2527	Miss Galbraith
25		Gloria Gargiulo	825-4074	Miss Yelland
25		Dolly Martin	872-3525	Miss Yelland
26		Irene Wood	872-8627	Miss Tracy
26		Mary Tragner	CU 5-9502	Miss Tracy
27		Doris Horowitz	825-2865	Miss Donahue
27		Connie Jurcsak	872-3916	Miss Donahue
27		Terry Keller	CU 5-7016	Miss Donahue
28		Irene Kielawa	LO 1-1075	Mrs. Wicht
28		Kay Schmidt	872-8692	Mrs. Wicht
28		Joan King	CU 5-9718	Mrs. Wicht
22		Terry Annarumma	285-9336	Miss Melzer
22		Lois Barry	CU 5-8654	Miss Melzer
22		Jean Saladino	872-8613	Miss Melzer
21		Hilda Flynn	VA 5-6091	Mr. Cooper
21		Gloria Corradi	CU 5-5255	Mr. Cooper
21		Evelyn Pearlman	CU 5-5723	Mr. Cooper
24		Josephine Balsano	CU 5-9700	Mrs. Gropper
24		Kay Ciccone	LO 1-9207	Mr. Gropper
24		Connie Deering	CU 5-6210	Mr. Gropper

FOREST ROAD SCHOOL

CLASS MOTHER LIST

		Class Mother Chairmen				
		Marcia Balaban and Ruth Misrock				
Grade	Room	Class Mother	Tel. Number	Teacher		
K	AM	Bonnie Kagan	561-7205	Mrs. Roth		
K	AM	Florence Goldberg	PY 1-7746	Mrs. Roth		
*K	PM	Renee Pepper	PY 1-3857	Mrs. Roth		
K	PM	Marlyn Fogel	PY 1-4701	Mrs. Roth		
*1	203	Doris Bernanke	PY 1-3790	Miss Cafiso		
1	203	Felicia Katz	PY 1-9501	Miss Cafiso		
1	204	Marge White	PY 1-5361	Mrs. Burns		
1	204	June Kaye	PY 1-2689	Mrs. Burns		
2	205	Diane Kahn	PY 1-4756	Miss Post		
*2	205	Phyllis Phillips	PY 1-2317	Miss Post		
2	206	Norma Kronenberg	PY 1-3184	Miss Perrich		
2	206	Roslyn Eisenberg	PY 1-3246	Miss Perrich		
3	207	Marilyn Dender	PY 1-5504	Mrs. Cummings		
*3	207	Elaine Chaloff	PY 1-6480	Mrs. Cummings		
3	209	Alberta Schectman	PY 1-3471	Miss Clarke		
3	209	Pearl Lustbader	PY 1-9854	Miss Clarke		
4	210	Olga Noto	PY 1-2241	Miss Bendin		
*4	210	Lennette Wolff	PY 1-8391	Miss Bendin		
4	211	Cindy Fischler	LO 1-1322	Miss Nancken		
4	211	Marie D'Allesandro	PY 1-4194	Miss Nancken		
5	212	Lillian Spector	PY 1-2627	Mrs. Parker		
*5	212	Eileen Silver	PY 1-2060	Mrs. Parker		
5	214	Beverly Brosterman	PY 1-7021	Miss Duck		
5	214	Louise Epstein	PY 1-3959	Miss Duck		
5	216	Marcia Chaiet	PY 1-2641	Mrs. Neuman		
5	216	Miriam Kaplan	PY 1-2265	Mrs. Neuman		
6	218	Lois Apfelbaum	PY 1-4468	Mrs. Melnick		
6	218	Dorothy Sarnataro	PY 1-9821	Mrs. Melnick		
6	218	Sylvia Rabin	PY 1-8637	Mrs. Melnick		
*6	220	Marge Grauer	PY 1-6043	Mr. Kaufmann		
6	220	Ruth Weinstein	PY 1-9045	Mr. Kaufmann		
6	220	Kitty Chimbel	PY 1-6642	Mr. Kaufmann		
Learning Lab	215	Lillian Ging	CU 5-6072	Miss Kreshover		

*Grade Coordinator

AUGUST 1970

DAY	MONDAY	TUESDAY	WEDNESDAY	THURSDAY	FRIDAY	SATURDAY
						1
2	3	4	5	6	7	8
					SUMMER RECREATION ENDS	
9	10	11	12	13	14	15
		C.H.S. Bd. of Ed. Mtg., 8:00 p.m.				
16	17	18	19	20	21	22
23	24	25	26	27	28	29

**UNION FREE SCHOOL DISTRICT No. 30 AND
CENTRAL HIGH SCHOOL DISTRICT No. 1,
VALLEY STREAM, NEW YORK**

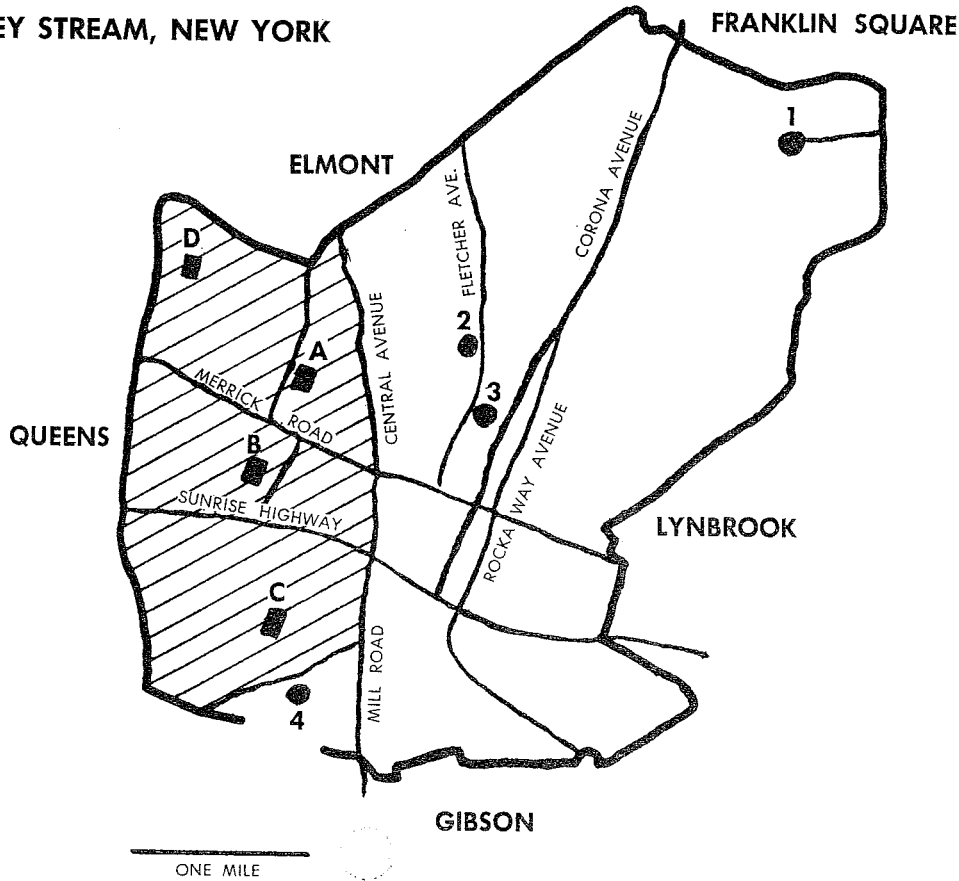

DISTRICT No. 30 SCHOOLS

- Shaw Avenue A
- Clear Stream Avenue B
- Forest Road C
- Washington Avenue D

Shaded Area — District 30

HIGH SCHOOLS

- North High 1
- Memorial Junior 2
- Central High 3
- South High 4

SCHOOL TELEPHONE DIRECTORY

Principal's Office: SHAW AVENUE SCHOOL
Principal VA 5-9131
Nurse's Office VA 5-9131
District Manager VA 5-9131

Clear Stream Avenue School
Principal's Office VA 5-3044
Nurse's Office VA 5-3044

Forest Road School
Principal's Office PY 1-7676
Nurse's Office PY 1-7676

Shaw Avenue School
Principal's Office VA 5-9131
Nurse's Office VA 5-9131

Washington Avenue School
Office VA 5-9131

Special Services
Administrative Assistant/Curriculum VA 5-9131
Psychologist VA 5-9131
Speech Consultant VA 5-9131
Reading Consultant VA 5-9131
Audio-Visual Consultant LO 1-1165

INDEX

Board of Education and School Calendar see October
Administration and Special Services see November
Clear Stream PTA see December
Shaw and Washington Avenue PTA see January
Forest Road PTA see February
Some Questions
Parents Ask see March
Why We Need More
State Aid see April
School Policies see May and June
Shaw and Washington Class Mothers see July
Clear Stream and Forest Class Mothers see August
Map of the District see facing page

CENTRAL HIGH SCHOOL DISTRICT NO. 1
Telephone Number: VA 5-8642
Use this number for all high school buildings, offices and personnel

NOTES

FOR 1969-1970

Calendar

SCHOOL ACTIVITIES

UNION FREE SCH. DL DISTRICT THIRTY
VALLEY STREAM, NEW YORK

30

UNION FREE SCHOOL DISTRICT THIRTY
VALLEY STREAM, NEW YORK

30

SCHOOL ACTIVITIES

Calendar

FOR 1970-1971

PUBLISHED BY THE BOARD OF EDUCATION AND PARENT-TEACHER ASSOCIATIONS

TELEPHONE DIRECTORY

INDEX

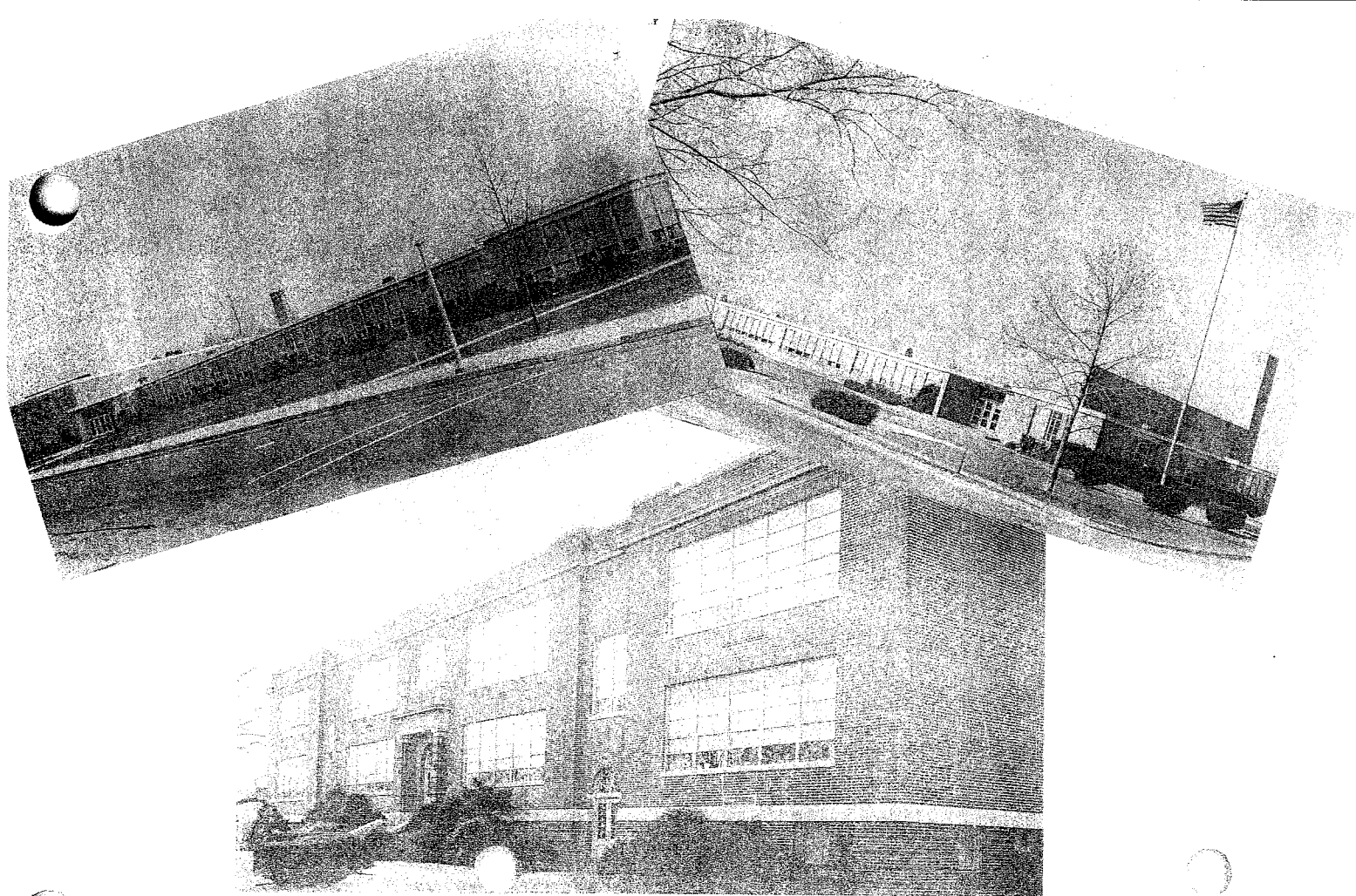

SEPTEMBER 1970

SUNDAY	MONDAY	TUESDAY	WEDNESDAY	THURSDAY	FRIDAY	SATURDAY
<p>partisan, when he is engaged in dispute, cares nothing about the rights of the question, but is only to convince his hearers of his own assertions.</p> <p style="text-align: right;">— Socrates</p>		1	2 PTA Exec. Bd. Mtg. Forest, 8:30 p.m.	3	4	5
6	7 LABOR DAY	8 C.H.S. Board Meeting 8 p.m. Faculty Meeting	9 SCHOOL OPENS	10 PTA Exec. Bd. Mtg., Clear Stream, 1:15 p.m. PTA Book Cover Sale Clear Stream	11	12
13	14	15 Parent's Night Wash. Ave., 8:15 p.m.	16 PTA Exec. Bd. Mtg., Shaw, 1 p.m.	17	18	19
20	21	22 Dist. 30 Bd. of Ed. Mtg. 8:15; Parent's Night Shaw, (K-3), 8:15 p.m.	23 Meet the Teacher Night Forest, 8:30 p.m.	24	25	26
27	28	29 PTA Parent's Night, Clear Stream, (K-1) 7:30 (2-3) 8:15 p.m. Parent's Night, Shaw, (4-6), 8:15 p.m.	30 PTA Parent's Night, Clear Stream (4-5) 7:30 - (6), 8:15 p.m.	<p>Peace, Peace is what I seek, and public calm: Endless extinction of unhappy hates. — From Merope by Matthew Arnold</p> <p>It were not best that we should all think alike; It is difference of opinion that makes horse-races. — Mark Twain</p>		

BOARD OF EDUCATION



Standing (left to right): Eleanor Zeller, Board Clerk; George Adams, School Attorney; Joseph Barry; Eleanor Berger, Board Treasurer; Sherwood Quick, District Principal. Seated: James R. Smith*, Vice-president; Nathaniel Altschul*, Elinor McAuliffe*, President; Robert Bell.

*Also serves on High School Board.

SCHOOL CALENDAR, 1970-1971

<table border="0"> <tr><td>Board Meetings (School District Conference)</td><td>Tues. Sept. 8</td></tr> <tr><td>Orientation</td><td>Tues. Sept. 8</td></tr> <tr><td>First Day of School</td><td>Wed. Sept. 9</td></tr> <tr><td>Rosh Hashanah</td><td>Thurs. & Friday Oct. 1 & 2</td></tr> <tr><td> Columbus Day</td><td>Mon. Oct. 12</td></tr> <tr><td> Veterans Day</td><td>Tues. Nov. 3</td></tr> <tr><td> Teachers' Day</td><td>Wed. Nov. 11</td></tr> <tr><td> Thanksgiving Recess</td><td>Schools close at end of morning session</td></tr> <tr><td></td><td>Wed. Nov. 25</td></tr> <tr><td></td><td>School Reopens</td></tr> <tr><td></td><td>Nov. 30</td></tr> </table>	Board Meetings (School District Conference)	Tues. Sept. 8	Orientation	Tues. Sept. 8	First Day of School	Wed. Sept. 9	Rosh Hashanah	Thurs. & Friday Oct. 1 & 2	Columbus Day	Mon. Oct. 12	Veterans Day	Tues. Nov. 3	Teachers' Day	Wed. Nov. 11	Thanksgiving Recess	Schools close at end of morning session		Wed. Nov. 25		School Reopens		Nov. 30	<table border="0"> <tr><td>Christmas Recess</td><td>School closes at regular time</td><td>Wed. Dec. 23</td></tr> <tr><td></td><td>School Reopens</td><td>Mon. Jan. 4</td></tr> <tr><td>Lincoln's Birthday</td><td></td><td>Fri. Feb. 12</td></tr> <tr><td>Washington's Birthday</td><td></td><td>Mon. Feb. 15</td></tr> <tr><td>Valley Stream Conference</td><td></td><td>Fri. Mar. 5</td></tr> <tr><td>Easter Recess</td><td>School closes at regular time</td><td>Wed. April 7</td></tr> <tr><td></td><td>School Reopens</td><td>Mon. April 19</td></tr> <tr><td>Memorial Day</td><td></td><td>Mon. May 31</td></tr> <tr><td>School Closes for Pupils</td><td></td><td>Fri. June 25</td></tr> <tr><td>School Closes for Teachers</td><td></td><td>Fri. June 25</td></tr> </table>	Christmas Recess	School closes at regular time	Wed. Dec. 23		School Reopens	Mon. Jan. 4	Lincoln's Birthday		Fri. Feb. 12	Washington's Birthday		Mon. Feb. 15	Valley Stream Conference		Fri. Mar. 5	Easter Recess	School closes at regular time	Wed. April 7		School Reopens	Mon. April 19	Memorial Day		Mon. May 31	School Closes for Pupils		Fri. June 25	School Closes for Teachers		Fri. June 25
Board Meetings (School District Conference)	Tues. Sept. 8																																																				
Orientation	Tues. Sept. 8																																																				
First Day of School	Wed. Sept. 9																																																				
Rosh Hashanah	Thurs. & Friday Oct. 1 & 2																																																				
Columbus Day	Mon. Oct. 12																																																				
Veterans Day	Tues. Nov. 3																																																				
Teachers' Day	Wed. Nov. 11																																																				
Thanksgiving Recess	Schools close at end of morning session																																																				
	Wed. Nov. 25																																																				
	School Reopens																																																				
	Nov. 30																																																				
Christmas Recess	School closes at regular time	Wed. Dec. 23																																																			
	School Reopens	Mon. Jan. 4																																																			
Lincoln's Birthday		Fri. Feb. 12																																																			
Washington's Birthday		Mon. Feb. 15																																																			
Valley Stream Conference		Fri. Mar. 5																																																			
Easter Recess	School closes at regular time	Wed. April 7																																																			
	School Reopens	Mon. April 19																																																			
Memorial Day		Mon. May 31																																																			
School Closes for Pupils		Fri. June 25																																																			
School Closes for Teachers		Fri. June 25																																																			

OCTOBER 1970

SUNDAY	MONDAY	TUESDAY	WEDNESDAY	THURSDAY	FRIDAY	SATURDAY
Runners in a race do not stop short when they reach the goal. There is a little gas left in the canter before coming to a standstill. There is time to hear the kind words of friends and to say to one's self: "The race is over, but the work is never done while the power to work remains." The canter that brings you to a standstill is only a moment before you will be coming to rest. It cannot be, while you still live. For to live is to work. That is all there is to living. — Oliver Wendell Holmes, Jr.						
4	5	6	7 PTA Exec. Bd. Mtg., Forest, 8:30 p.m.	8 PTA Exec. Bd. Mtgs., Clear Stream, 8:15 p.m. Shaw, 1:00 p.m.	9 Cultural Arts Assembly Shaw	10 YOM KIPPUR
11	12 COLUMBUS DAY SCHOOL CLOSED	13 C.H.S. Bd. Meeting 8:00 p.m.	14	15 SUKKOT PTA Gen. Mtg., Clear Stream, 8:15 p.m.	16 SUKKOT	17
18	19	20 PTA Jelly Apple Sale, Clear Stream	21 PTA Gen Mtg., Forest, 8:30 p.m. PTA Gen Mtg., Shaw, 8:15 p.m.	22 LAST DAY OF SUKKOT	23	24 Children's Theatre — Central High — "The Blue Planet" 11:00 a.m.
25	26	27 District No. 30 Bd. of Ed. Mtg., 8:15 p.m.	28 PTA Jelly Apple & Pretzel Sale, Shaw, 2:30 - 3:30 p.m.	29	30 Halloween Party, 5th & 6th Grade, Clear Stream	31 HALLOWEEN North-South Football Game

SCHOOL ADMINISTRATION

Dr. William T. Callahan, *District Superintendent*

Sherwood S. Quick
District Principal

SCHOOL PRINCIPALS

CLEAR STREAM AVENUE SCHOOL
Richard M. Burbell

FOREST ROAD SCHOOL
Maurice E. St. Mary

SHAW AVENUE SCHOOL
Lawrence Cid

William J. Van Ness, *Administrative Assistant/Curriculum*
George W. Niederhauser, *Administrative Assistant/Business*

SCHOOL SECRETARIES

Jeanne Feeney, Clear Stream Avenue
Mary McDowell, Forest Road
Jean Annona, Shaw Avenue

DISTRICT SECRETARIAL STAFF

Margaret Bradley Lucy Felice Helen Kuchler
Marie O'Connell Marcella Pantaleo Mary Ribando
Edythe Sanchez Caroline Young

Evelyn Pearn, *Cafeteria Manager*

DISTRICT SPECIALISTS AND SPECIAL TEACHERS

Frank DeMarco, *Director of Educational Communications*
Rosalyn Kessler, *Psychologist*
Estelle Friedman, *Psychologist*
Raydine Teicheira, *Speech Consultant*
Frances Pollet, *Speech Teacher*
Dolores Stein, *Foreign Language Consultant*
John Price, *Instrumental Music Teacher*
Margo Sokolow, *Instrumental Music Teacher*

OTHER SPECIALISTS AND SPECIAL TEACHERS

Clear Stream Avenue School

Cathleen Meneilly, *Special Counselor*
Janet Poppe, *Reading Specialist*
Grace Giacobone, *Art*
Philip Hessemer, *Physical Education*
Joan Henningsen, *Physical Education*
Linda Pratt, *Music*
Ruth Newman, *Librarian*
Edna Giebel, *Nurse-Teacher*

Forest Road School

Special Counselor to be appointed
Ada Keaney, *Reading Consultant*
Jean Ritzenthaler, *Art*
Alfred Stevens, *Physical Education*
Joan Henningsen, *Physical Education*
Frances Butler, *Music*
Rose Agree, *Librarian*
Hilda Rosenfeld, *Nurse-Teacher*

Shaw Avenue School

Noel Giambalvo, *Special Counselor*
Jeanne Colton, *Reading Specialist*
Rosemary Paradiso, *Reading Teacher*
Louise Holbrook, *Art*
Linda Sleiertin, *Art*
Thomas Rouse, *Physical Education*
Carol Gallof, *Physical Education*
Kathryn Egan, *Music*
Sylvia Berkowitz, *Librarian*
Dorothy McCutchan, *Nurse-Teacher*

NOVEMBER 1970

SUNDAY	MONDAY	TUESDAY	WEDNESDAY	THURSDAY	FRIDAY	SATURDAY
1	2	3 ELECTION DAY SCHOOL CLOSED	4 Jelly Apple Sale, Clear Stream PTA Exec. Bd. Mtgs., Forest, 8:30 p.m. Shaw, 1:00 p.m.	5 PTA Exec. Bd. Mtg., Clear Stream, 1:15 p.m.	6	7
8	9 Inter-School PTA, Shaw, 1:00 p.m.	10 C.H.S. Bd. Meeting 8:00 p.m.	11 VETERANS DAY SCHOOL CLOSED Children's Movie Clear Stream & Shaw	12	13	14 PTA Carnival, Forest Road
15	16	17 Pre-School Mtg., Forest 3:00 p.m.	18 Report Cards sent home PTA Gen. Mtg., Forest, 8:30 p.m.	19 PTA Exchange Sale, Clear Stream	20 PTA Family Night Movie, Clear Stream	21
22	23	24 District No. 30 Bd. of Ed. Mtg., 8:15 p.m.	25 SCHOOL CLOSURE AT THE END OF THE MORNING SESSION	26 THANKSGIVING RECESS	27 THANKSGIVING RECESS	28
29 SCHOOL REOPENS	30	No warmth, no cheerfulness, no healthful ease, No comfortable feel in any member — No shade, no shine, no butterflies, no bees, No fruits, no flowers, no leaves, no birds, November! — Thomas Hood		November's sky is chill and drear, November's leaf is red and sear. — Sir Walter Scott When chill November's surly blast Made fields and forest bare. — From Man Was Made to Mourn, by Robert Burns		

CLEAR STREAM AVENUE PARENT TEACHER ASSOCIATION

ELECTED OFFICERS 1970-1971

President	Jeanette Ermler	825-6368
First Vice President	Ann Docar	CU 5-8914
Second Vice President	Kay Ciccone	LO 1-9207
Treasurer	Hilda Flynn	825-6081
Membership	Elena Cerenza	CU 5-5671
	Margie Croak	825-9352
Recording Secretaries	Edna Giebel	
	Mrs. Lake	
Corresponding Secretary	Connie Deering	CU 5-6210
Delegates to V. S. Council	Marilyn Margolies	CU 5-8973
	Marie LiRosi	285-8020
Past President	Ruth Cornish	872-3020

Kindergarten Rep.	Margie McGovern	CU 5-9011
1st Grade Rep.	Jean Saverese	CU 5-5116
2nd Grade Rep.	Mary Tragnor	CU 5-5902
3rd Grade Rep.	Mary Amman	CU 5-6090
4th Grade Rep.	Marie Pascuzzi	825-8401
5th Grade Rep.	Ann Prisco	CU 5-5754
6th Grade Rep.	Pat Strobl	825-4640
6th Gr. Liaison Ch. C.M.	Kay Schmidt	872-8692
Rep. P.T.A. Educa. Comm.	Lois Barry	CU 5-8654
	Muriel Watterson	825-5478

P.T.A. PROGRAM

Sept.	10	Executive Board Meeting—1:15 P.M.; Book Cover Sale
	29	Parents' Night (K-1) 7:30 P.M. and (2-3) 8:15 P.M.
	30	Parents' Night (4-5) 7:30 P.M. (6) 8:15 P.M.
Oct.	8	Executive Board Meeting—8:15 P.M.
	15	General Meeting—8:15 P.M.
	20	Jelly Apple Sale
	24	Children's Theatre at Central High—The Blue Planet
	30	Halloween Party Grades 5 & 6
Nov.	4	Jelly Apple Sale
	5	Executive Board Meeting — 1:15 P.M.
	11	Children's Movie
	19	Exchange Sale
	20	Family Night Movie
Dec.	3	Executive Board Meeting—1:15 P.M.
	8	Pre-School
	17	Holiday Assembly—Aladdin's Lamp
	19	Children's Theatre at Central High—Gabriel Ghost
Jan.	7	Executive Board Meeting—1:15 P.M.
	14	General Meeting—8:15 P.M.
Feb.	4	Executive Board Meeting—1:15 P.M.
	10	Cake Sale
	18	General Meeting—3:15 P.M.
Mar.	4	Executive Board Meeting—8:15 P.M.
	6	Children's Theatre at Central High—Greensleeves
	9	Pre-School Meeting
	18	General Meeting—8:15 P.M.
	22	Sex Hygiene Meeting—6th Grade Parents—8:00 P.M.
	23	Sex Hygiene Meeting—5th Grade Girls—3:00 P.M.
	26	Father, Son & Daughter Night
	29	Sex Hygiene Meeting—5 & 6 Grade Boys & Girls—7:30 P.M.
Apr.	1	Executive Board Meeting—8:15 P.M.
	22	Workshop—8:15 P.M.
May	6	Executive Board Meeting—1:15 P.M.
	8	Amblyopia Testing
	12	Teachers' Recognition Luncheon
	15	Amblyopia Testing
	27	General Meeting—Installation—8:15 P.M.
	24	Bookmobile
	25	Bookmobile
	26	Bookmobile
June	3	Joint Board Meeting—8:00 P.M.

COMMITTEE CHAIRMEN

Arts and Flyers	Joy Roccanova	285-8860
	Rose McMeekin	285-9820
Audio-Visual	Frank DeMarco	Faculty
Budget	Ruth Cornish	872-3020
Cultural Arts	Lois Barry	CU 5-8654
Health	Ann Planco	561-6514
Historian	Dorothea Munson	LO 1-2547
Legislation	Mrs. Felecia	LO 1-0938
	Irving & Jane Goodman	872-8838
	Lois Barry	CU 5-8654
Mimeographer	Mary Amman	CU 5-6090
Pre-School	Kay Ciccone	LO 1-9207
Program	Ann Docar	CU 5-8914
School & Community Relations	Edna Giebel	Faculty
Safety	Irene Wood	872-8627
Sunshine	Grace Landon	825-3491
THE STREAMER		
Editor	Muriel Watterson	825-5478
Distribution	Doris Morowitz	825-2865
Typists	Gloria Gargulio	825-4074
	Margie Croak	825-9352
Ways & Means: Chrm. & Movies	Kay Schmidt	872-8692
	Marilyn Rubin	LO 1-9185
Bowling	Evelyn McGowan	285-4712
	Marie Grande	LO 1-6310
	Terry Keller	CU 5-7016
Hospitality	Jennie Tretolo	LO 1-2527
	Ann Prisco	CU 5-5754
	Gloria Corradi	CU 5-5255
Publicity	Ruth Cornish	872-3020
Publications	Beverly Jablonowski	825-2489

DECEMBER 1970

DAY	MONDAY	TUESDAY	WEDNESDAY	THURSDAY	FRIDAY	SATURDAY
	<p>ices in December, ice in June; constancy in wind, or corn aff;</p> <p>a woman or an epitaph, other thing that's false, you trust in critics.</p> <p style="text-align: right;">— Lord Byron</p>	1	2	3	4	5
		Pre-School Mtg., Wash. & Shaw, 3:00-3:30 p.m.	P.T.A. Exec. Bd. Mtgs., Forest, 8:30 p.m. Shaw, 1:00 p.m.	P.T.A. Exec. Bd. Mtg., Clear Stream, 1:15 p.m.		
6	7	8	9	10	11	12
		C.H.S. Bd. Meeting, 8:00 p.m. Pre-School Mtg., Clear Stream	Pre-School Mtg., Forest, 2:00 p.m.		P.T.A. Holiday Assembly Shaw	
13	14	15	16	17	18	19
			P.T.A. Holiday Assembly Forest	P.T.A. Holiday Assembly Clear Stream		Children's Theatre Central High "Gabriel's Ghost" 11:00 a.m.
20	21	22	23	24	25	26
		District No. 30 Bd. of Ed. Mtg., 8:15 p.m.	SCHOOL CLOSURES AT REGULAR TIME	SCHOOL CLOSED	CHRISTMAS DAY	
27	28	29	30	31	Always do right. This will gratify some people, and astonish the rest. Mark Twain	

SHAW AND WASHINGTON AVENUES PARENT TEACHER ASSOCIATION

ELECTED OFFICERS 1970-1971

President	Lillian Fayet	561-6973
Vice President	Angela Carmosino	872-8259
Immediate President	Jean Layden	285-7624
Recording Secretary	Ida Ierardi	CU 5-6047
Financial Secretary	Marilyn D'Angelo	872-3567
Corresponding Secretary	Marie Cecere	VA 5-9406
Delegates to Council	Betsey Pine	CU 5-5806
	Louise Kiel	CU 5-9651
	Elaine Eichlin	Faculty
President	Stella Schlaeger	CU 5-7588

COMMITTEE CHAIRMEN

Visual Arts	John Giacalone	Faculty
Visual Arts	Stella Schlaeger	CU 5-7588
Visual Arts	Fran Dickinson	CU 5-9496
Visual Arts	Susan Barnaby	Faculty
Visual Arts	Kay Hadjiyane	CU 5-7434
Visual Arts	Lila Markowitz	285-5009
Visual Arts	Vita Capposella	285-6160
Visual Arts	Marie DiGiamo	LO 1-0079
Visual Arts	Jean Davis	872-3938
Visual Arts	Grace Pisano	872-3097
Visual Arts	Marie Cecere	VA 5-9406
Visual Arts	Dee Robson	825-0598
Visual Arts	Angela Carmosino	872-8259
Visual Arts	Stella Schlaeger	CU 5-7588
Visual Arts	Kay Hadjiyane	CU 5-7434
Visual Arts	Gloria Zweier	825-9001
Visual Arts	Jean Layden	285-7624
Visual Arts	Sylvia Guttenplan	CU 5-7010
Visual Arts	Harriet Kraft	Faculty
Visual Arts	Stella Schlaeger	CU 5-7588
Visual Arts	Cathy Dwyer	CU 5-5283
Visual Arts	Rita Dolan	CU 5-6008
Visual Arts	Judith Blessinger	Faculty
Visual Arts	Angela Carmosino	872-8259
Visual Arts	Marilyn D'Angelo	872-3567
Visual Arts	George & Stella Schlaeger	CU 5-7588
Visual Arts	Louise Kiel	CU 5-9651
Visual Arts	Grace Pisano	872-3097
Visual Arts	Jean Layden	285-7624
Visual Arts	Stella Schlaeger	CU 5-7588

Fashion Show	Angela Carmosino	872-8259
Fashions and Decorations	Marie Cecere	VA 5-9406
Refreshments	Jo Diaz	CU 5-6126
Raffles	Stella Schlaeger	CU 5-7588
Tickets	Lonnie DiLuccio	LO 1-6837
Kindergarten Rep.	Anita Filosa	LO 1-0074
1st Grade Rep.	Ruth Cohen	VA 5-4381
2nd Grade Rep.	Lillian Ging	CU 5-6072
3rd Grade Rep.	Maureen Pascale	825-0303
4th Grade Rep.	Dee Robson	825-0598
5th Grade Rep.	Ida Ierardi	CU 5-6047
6th Grade Rep.		

P.T.A. PROGRAM

Sept.	15	Parent's Night — Washington Ave. — 8:15 p.m.
	16	Executive Board Meeting — 1:00 p.m.
	22	Parent's Night — Shaw Ave. — K to 3: 8:15 p.m.
	29	Parent's Night — Shaw Ave. — 4 to 6: 8:15 p.m.
Oct.	7	Executive Board Meeting — 1:00 p.m.
	9	Cultural Arts Assembly
	21	General Meeting — 8:15 p.m.
	28	Jelly Apple & Pretzel Sale — 2:30 to 3:30 p.m.
Nov.	4	Executive Board Meeting — 1:00 p.m.
	11	Movie
Dec.	1	Pre-School Meeting — Wash. & Shaw Ave. — 3:00 to 3:30 p.m.
	2	Executive Board Meeting — 1:00 p.m.
	11	Holiday Assembly for Children
Jan.	6	Executive Board Meeting — 1:00 p.m.
	13	General Meeting — Afternoon
	19	Pre-School Meeting — Washington Ave. & Shaw Ave. 3:00 to 3:30 p.m.
Feb.	17	Founder's Day
Mar.	3	Executive Board Meeting — 1:00 p.m.
	5	Movie
	9	Pre-School Meeting — Washington Ave. & Shaw Ave. 3:00 to 3:30 p.m.
	10	Fashion Show
	24	General Meeting — Afternoon — (Mental Health)
	31	Executive Board Meeting — 1:00 p.m.
April	20	Parent Ed. Meeting — Shaw — Mothers — 1:00 p.m.
	22	Parent Ed. Meeting — Shaw — 5th Grade Girls — 3:00 p.m.
	23	Parent Ed. Meeting — Shaw — 6th Grade Girls — 3:00 p.m.
	29	Parent Ed. Meeting — Shaw
		Fathers & 6th Grade Boys — 8:00 p.m.
May	6	Executive Board Meeting — 1:00 p.m.
	11	Teacher Recognition Day — Luncheon — Shaw
	19	Installation Night — General Meeting — 8:15 p.m.
June	2	Joint Executive Board Meeting — Afternoon

JANUARY 1971

SUNDAY	MONDAY	TUESDAY	WEDNESDAY	THURSDAY	FRIDAY	SATURDAY
					1	2
imitator is a poor kind of teacher. If a man paints only the tree, or flower, or other surface ees before him were an artist, the King of artists would be the photographer. It is for the t to do something beyond this: in portrait painting to put on canvas something more than face the model wears for that day; to paint the man, in short, as well as his features.						NEW YEAR'S DAY SCHOOL CLOSED
	3	4	5	6	7	8
	SCHOOL REOPENS		PTA Exec. Bd. Mtgs., Forest 1:00 p.m. Shaw 1:00 p.m.	PTA Exec. Bd. Mtg., Clear Stream 1:15 p.m.		
	10	11	12	13	14	15
		C.H.S. Board Meeting 8:00 p.m.	PTA Gen. Mtg., Shaw Afternoon	PTA Gen. Mtg., Clear Stream, 8:15 p.m.	Pre-School Mtg., Forest, 2:00 p.m.	16
	17	18	19	20	21	22
		Pre-School Mtg., Wash. & Shaw, 3:00 - 3:30 p.m.	PTA Gen. Mtg., Forest Road, 1:00 p.m.			23
	24	25	26	27	28	29
	31		District No. 30 Ed. of Ed. Assn.			30

First Vice President
 Second Vice President
 Third Vice President
 Treasurer
 Financial Secretary
 Corresponding Secretary
 Recording Secretary
 Delegate to Council

Renee Pepper 791-3857
 Marcia Chaiet 791-2641
 Phyllis Wolin 791-8120
 Len Wolff 791-8391
 Alberta Schectman 791-3471
 Nancy Cesta 791-8028
 Selma Singer 791-3592
 Marcia Balaban 791-7598

COMMITTEE CHAIRMEN

Budget Alberta Schectman 791-3471
Class Mother Marcia Balaban 791-7598
 Ruth Misrok 791-2597
Family Living Barbara O'Reilly 791-4068
Flyers Evelyn Grabois 791-1604
 Louise Printz 791-6951
 Dottie Singer 791-9631
Goodwill Esther Behar 791-7644
Hospitality Judy Orloff 791-3820
 Barbara Rovin 791-1360
Historian Frieda Markinson 791-2715
Health & Safety Evelyn Levy 791-2651
Legislation Lillian Spector 791-2627
Library & Book Fair Marilyn Fogel 791-4701
 Diane Kahn 791-4756
Mimeograph Doris Bernanke 791-3790
 Roslyn Eisenberg 791-3246
Music & Art Pearl Lustbader 791-9547
 Corky Shaw 791-8807
 Susan Yarrin 791-2999
Newsletter Ann Berger 791-4088
Parent Education Sheila Shear 791-3883
 Judy Nadler 825-0247
 (Curric. Study) Florence Shapiro 791-7567
 Bonnie Kagan 561-7206
 Jack Klein 791-3060
Parliamentarian Cindy Sarnetaro 791-8133
Posters Rachel Ladetsky 791-3995
Pre-School Phyllis Finkle 791-2568
Publications Roslyn Drexler 791-2709
 Carol Andiman 791-4686
Publicity Florence Avron 791-3631
 Toby Kaller 791-2104
School & Comm. Relations Ruth Misrok 791-2597
 Phyllis Phillips 791-2317
 Phyllis Abelow 791-7951
School Bd. Rep. - Elem. Harriet Naschek 791-2194
School Bd. Rep. - H.S. Madeline Margulies 791-5097
Teacher Rep. Anita Strelsker 791-7167
Typist Phyllis Wolin 791-8120
Ways & Means

Sept. 2 Executive Board Meeting — 8:30 p.m.
 9 School Re-opens
 23 Meet the Teacher Night — 8:30 p.m.
 Oct. 1 Rosh Hashanah — School Closed
 2 Rosh Hashanah — School Closed
 7 Executive Board Meeting — 8:30 p.m.
 10 Yom Kippur
 12 Columbus Day — School Closed
 15 Sukkot
 16 Sukkot
 21 General Meeting — 8:30 p.m.
 22 Last Day of Sukkot
 24 Children's Theatre — 11:00 a.m. — Blue Planet
 31 Halloween — North-South Game
 Nov. 3 Election Day — School Closed
 4 Executive Board Meeting — 8:30 p.m.
 9 Inter-School PTA — Shaw Ave. — 1:00 p.m.
 11 Veterans' Day — School Closed
 14 Carnival
 17 Pre-School Meeting — 3:00 p.m.
 18 General Meeting — 8:30 p.m.
 25 Half-Day School
 26 School Closed until November 30
 Dec. 2 Executive Board Meeting — 8:30 p.m.
 9 Pre-School Meeting — 2:00 p.m.
 16 Holiday Gift to Children
 19 Children's Theatre — 11:00 a.m. — Gabriel's Ghost
 24 School Closed until January 4
 Jan. 4 School Opens
 6 Executive Board Meeting — 1:00 p.m.
 15 Pre-School Meeting — 2:00 p.m.
 20 General Meeting — 1:00 p.m.
 Feb. 3 Executive Board Meeting — 1:00 p.m.
 12 Lincoln's Birthday — School Closed
 15 Washington's Birthday — School Closed
 16 Pre-School Meeting — 3:00 p.m.
 17 Founder's Day — 8:30 p.m.
 24 Ash Wednesday
 Mar. 3 Executive Board Meeting — 8:30 p.m.
 5 Teacher Conference — School Closed
 6 Children's Theatre — 11:00 a.m. — Greensleeves
 15 Pre-School Meeting — 2:00 p.m.
 17 General Meeting — 8:30 p.m.
 April 4 Palm Sunday
 8 School Closed
 9 Good Friday
 10 Passover
 11 Easter Sunday
 12-18 Easter Vacation
 19 School Re-opens
 21 Pre-School Meeting — 3:00 p.m.
 26 Sex Hygiene Meeting — 6th Grade Parents — 8:30 p.m.
 27 Sex Hygiene Meeting — 6th Grade Girls — 2:45 p.m.
 28 Sex Hygiene Meeting — 5th Grade Girls — 2:45 p.m.
 29 Sex Hygiene Meeting — 6th Grade Boys — 8:00 p.m.
 May 5 Executive Board Meeting — 8:30 p.m.
 19 Installation — General Meeting — 8:30 p.m.
 30 Shavuot
 31 Memorial Day — School Closed
 June 2 Joint Boards Meeting — 8:30 p.m.
 25 Last Day of School

FEBRUARY 1971

DAY	MONDAY	TUESDAY	WEDNESDAY	THURSDAY	FRIDAY	SATURDAY
	1	2	3 Report cards sent home PTA Exec. Bd. Mtg., Forest, 1:00 p.m.	4 PTA Exec. Bd. Mtg., Clear Stream 1:15 p.m.	5	6
7	8	9 C.H.S. Bd. Meeting 8:00 p.m.	10 PTA Cake Sale Clear Stream	11	12 LINCOLN'S BIRTHDAY SCHOOL CLOSED	13
14	15 WASHINGTON'S BIRTHDAY CELEBRATED SCHOOL CLOSED	16 Pre-School Mtg., Forest, 3:00 p.m.	17 FOUNDER'S DAY PTA Mtg., Forest, For all schools in the District, 8:30 p.m.	18 PTA Gen. Mtg., Clear Stream 3:15 p.m.	19	20
21	22	23 District No. 30 Bd. of Ed. Mtg., 8:15 p.m.	24 ASH WEDNESDAY	25	26	27

28 George Washington, Commander of the American armies, who, like Joshua of old, commanded the sun and the moon to stand still, and they obeyed him.
 — A toast at a dinner in Versailles by Benjamin Franklin

Abraham Lincoln . . . who was at home and welcome with the humblest, and with a spirit and practical vein in the times of terror that commanded the admiration of the wisest. His heart was as great as the world, but there was no room in it to hold the memory of a wrong.
 — Ralph Waldo Emerson

SAFETY FOR YOUNGSTERS IS A COOPERATIVE AFFAIR

It is the observation of all school personnel that safety for youngsters is a joint responsibility of both parents and the school. This being true, we would like to point out several areas wherein all of us can improve this important aspect of growing youth.

It would seem that many parents do not realize that when they sign permission slips to allow their children to go out for lunch, rather than eating in the school cafeteria or at home, they are allowing these boys and girls to be unsupervised for a minimum of an hour each day. In addition, when a child goes to a delicatessen or lunch counter for lunch, he is not permitted to return to the school until the afternoon session begins; so again he is unsupervised during this period of time.

In the same vein, many children arrive at school each day as much as an hour before school begins. No supervision is provided on the playground before school begins in the morning; so once again some very young children are "on their own" — unsupervised — for quite a long period of time.

The playgrounds are not supervised after school hours, nor on weekends or holidays, and many children are climbing fences and even onto the school roofs! Do we need to mention how dangerous this is?

A further hazard needs to be stressed which is directly under the control of parents and that is parking in restricted areas on rainy days to pick up children. The reason for the restrictions on parking is to safeguard *your children* and when you disobey these signs, you are endangering the safety of your child and showing a disregard for rules. Children of elementary school age are often oblivious to hazards of which adults are automatically aware.

The use of the playgrounds for minibikes and bicycles is another dangerous practice we need to call to your attention. Again, this happens after school hours, weekends, and holidays, when there is absolutely no supervision. The danger to other youngsters from these vehicles is very great and we are fortunate that no youngster, as yet, has been injured.

From the recent newspaper stories, we are sure you realize that the Nassau County Police are now enforcing the law in regard to fireworks. We in the schools must, in conscience, report any child who appears at school with fireworks, for the safety of the hundreds of children under our care.

Safety is important and vital and we bring all these facts to your attention with the hope that *together we can make it a safer community for all children.*

MARCH 1971

SUNDAY	MONDAY	TUESDAY	WEDNESDAY	THURSDAY	FRIDAY	SATURDAY
	1	2	3 PTA Exec. Bd. Mtgs., Forest, 8:30 p.m. Shaw, 1:00 p.m.	4 PTA Exec. Bd. Mtg., Clear Stream, 8:15 p.m.	5 TEACHERS' CONFERENCE DAY SCHOOL CLOSED Children's Movie, Shaw	6 Children's Theatre Central High "Greensleeves" 11:00 a.m.
7	8	9 C.H.S. Bd. Mtg., 8 p.m. Pre-School Meetings Clear Stream Wash. & Shaw, 3:00 - 3:30 p.m.	10 PTA Fashion Show Shaw	11	12	13
14	15 Pre-School Mtg., Forest, 2:00 p.m.	16	17 PTA Gen. Mtg., Forest, 8:30 p.m.	18 PTA Gen. Mtg., Clear Stream, 8:15 p.m.	19	20
21	22 Sex Hygiene Mtg., 6th Grade Parents Clear Stream, 8:00 p.m.	23 District No. 30 Bd. of Ed. Mtg. 8:15 p.m. Sex Hygiene Mtg. 5th Grade Girls Clear Stream, 3:00 p.m.	24 PTA Gen. Mtg. Shaw, Afternoon "Mental Health"	25	26 PTA Father-Son-Daughter Night Clear Stream	27
28	29	30 Sex Hygiene Mtg. 5th & 6th Grade Boys & Girls	31 PTA Exec. Bd. Mtg.,	A ship is always referred to as "she" because it costs so much to keep one in powder and paint. — Admiral Chester Nimitz I expect that women will be the last thing civilized by man. — George Meredith		

EDUCATIONAL SCHOOL SYSTEMS — VALLEY STREAM

In deference to the new residents of the district, and a refresher to those who have lived here for a while, we present an explanation of the make-up of the Valley Stream schools.

There are three elementary school districts (Nos. 13, 24, and 30) which are separate and autonomous. Each of these has school boards elected by the taxpayers of that district and each has its own budget upon which its voters must pass in any given year.

The Board of Education of Central High School District No. 1 is made up of three members from each of the three elementary school districts. These members are elected to serve on the high school board by the elementary school boards of education.

The Central High School budget is separate from the elementary budgets but is voted on each year at the same time — usually the first Wednesday in May.

Notwithstanding that each district is autonomous unto itself, there is great collaboration among the four districts. The Boards of Education have formed what is called the "Joint Boards" which meets several times each year to consider matters of mutual concern — i.e., teacher salaries and bylaws.

Cooperation among the districts is epitomized by a committee composed of representatives of each elementary district and the high school district (the Inter-district Committee). These staff members meet at least once a month and coordinate such matters as assignment of student teachers; curriculum areas, such as social studies, to insure continuity from the elementary schools to the high schools; the setting up of village-wide in-service courses for teachers; forming of evaluation committees to study some particular program (such a committee is now assessing our Foreign Language Program); and many other areas of concern to all Valley Stream schools.

The following diagram depicts just how the school districts are set up.

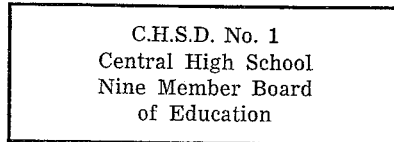

Three members of each elementary board of education are elected by the individual elementary boards to serve on the high school board of education.

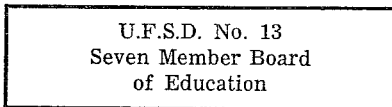

Taxpayers of this district vote on their own budget and school board members.

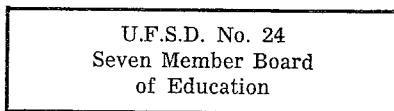

Taxpayers of this district vote on their own budget and school board members.

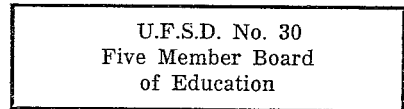

Taxpayers of this district vote on their own budget and school board members.

Taxpayers from three districts vote on the high school budget.

APRIL 1971

DAY	MONDAY	TUESDAY	WEDNESDAY	THURSDAY	FRIDAY	SATURDAY
				1	2	3
	April, thy girlish laughter; the moment after, thy girlish tears. — Sir William Watson	Men are April when they woo, December when they wed; Maids are May when they are maids, but the Sky changes when they are wives. — William Shakespeare		PTA Exec. Bd. Mtg., Clear Stream, 8:15 p.m.	Annual District Music Concert Shaw, 8:15 p.m.	
4	5	6	7	8	9	10
SUNDAY		Report cards sent home	SCHOOL CLOSURE AT REGULAR TIME	SCHOOL CLOSED	GOOD FRIDAY SCHOOL CLOSED	JEWISH PASSOVER
11	12	13	14	15	16	17
SUNDAY	SCHOOL CLOSED	C.H.S. Board Meeting 8:00 p.m. SCHOOL CLOSED	SCHOOL CLOSED	SCHOOL CLOSED	SCHOOL CLOSED	CONCLUSION OF PASSOVER
18	19	20	21	22	23	24
	SCHOOL REOPENS	Parent Ed. Mtg., Mothers, Shaw 1:00 p.m.	Pre-School Mtg., Forest, 3:00 p.m.	PTA Workshop Clear Stream, 8:15 p.m. Parent Ed. Mtg., Shaw, 5th Grade Girls 8:00 p.m.	Reg. for next yr. Kind. each school 9-11 a.m. Parent Ed. Mtg., Shaw, 6th Grade Girls 3:00 p.m.	Reg. for school voting 7 a.m. to 12 noon each school
25	26	27	28	29	30	
	Sex Hygiene Mtg., 6th Gr. Parents	Mtg. 8:15 p.m. Dist. 30 Bd. of Ed. Sex Hygiene Mtg., 6th Grade Girls	Sex Hygiene Mtg., Forest, 5th Gr. Girls	Sex Hyg., 6th Gr. Boys Forest, 8:00 p.m. Parent Ed. Mtg., Shaw	Reg. for school voting 4:00 to 10:00 p.m.	

SCHOOL POLICIES

SCHOOL HOURS

Hours for grades 1, 2, and 3 are from 9:00 a.m. to 3:00 p.m.
 Hours for grades 4, 5, and 6 are from 8:30 a.m. to 2:45 p.m.

LUNCH

Lunch is served beginning with the first day of school. Pupils who do not come home for lunch, bring lunch from home, or buy the school lunch in the cafeteria for 35c. Monthly menus are provided so that all pupils are served which your child does not eat, you can make other provisions for him for those days. In case a child loses his lunch money or his lunch, or loses either, we have a system to cover the emergency. The cashier in the cafeteria keeps the record of such charges and contacts the parents if a charge not be paid in a reasonable time.

ICE CREAM

Ice cream is sold daily to those pupils who wish it. It is not sold with the hot lunch and costs an additional 10c.

RECESS MILK

Recess milk is available to all children beginning about the first week of the school year and is sold at a cost of 15c per week each Thursday for the following week. You will be notified as to the exact date. Money brought in late (Friday) cannot be accepted. In case of a child's absence, no refund is made for periods of less than a full week.

ABSENCES

If your child has been absent, State law requires that he bring a note from you explaining the absences and the date(s) of absence(s). The note should be presented to the nurse before he comes to the classroom. Please be specific. Just saying, "he was absent" is not enough. Indicate whether it was "virus," "fever," "cold," etc. A note is required for an absence due to a religious observance. A note is required for any tardiness, giving the reason. If your child contracts a contagious disease, such as mumps, measles, etc., please phone the school nurse so that she can advise the parents in your child's class that their children have been exposed. Be sure to keep the emergency card up to date so that we will know whom to call should your child become ill and need to go home.

NOON HOUR RULES

When pupils misbehave in the cafeteria, auditorium, or on the playground during the noon hour, after repeated reminders, the teachers have the authority to exclude them from staying in school for lunch for a few days, or longer, depending on the misbehavior. If you receive such a note from us, we would appreciate your cooperation. Whether or not a mother is home during the noon hour has no bearing on this exclusion.

RELEASED TIME FOR RELIGIOUS INSTRUCTION

A Release Form signed by the parent is necessary should you want your child excused from school for religious instruction. Such forms can be obtained from your church. The time provided is the last hour of school on Wednesday afternoons.

EXITS AND ENTRANCES

Your child's class is assigned a specific exit and entrance to use. You will thus know where to meet him if you come to pick him up. Parents picking up children are asked to meet them at the exit, not the classroom.

ENTRANCE TIMES

Morning — All Schools	Noontime — Shaw & Forest
Grades 1, 2, & 3 — 8:50	Grades 1, 2, & 3 — 12:50
Grades 4, 5, & 6 — 8:20	Grades 4, 5, & 6 — 12:20
Noontime—Clear Stream: Grades 5 & 6—12:05	
Grades 3 & 4—12:35; Grades 1 & 2—1:05	

Because there is no supervision of the playground in the morning, we suggest you arrange your child's departure from home to allow him to arrive just in time to enter the building during the proper interval. In inclement weather he may come into the designated area five minutes before the above times.

CLASS INTERRUPTIONS

No unnecessary interruptions of classes are allowed once the day's sessions have begun. When your child forgets a book, homework, sneakers, lunch money, etc., please bring these to the office. All pupils are instructed to check with the office at lunch time for such forgotten items. In the interest of the child's all-round education, we urge you not to make a practice of bringing forgotten items to school. The child should be developing his own sense of responsibility for these things.

MAY 1971

SUNDAY	MONDAY	TUESDAY	WEDNESDAY	THURSDAY	FRIDAY	SATURDAY
2	3	4	5 Voting on school bud. 7 a.m. to 10 p.m. PTA Exec. Bd. Mtg., Forest, 8:30 p.m.	6 PTA Exec. Bd. Mtgs., Clear Stream, 1:15 p.m. Shaw, 1:00 p.m.	7	8 PTA Amblyopia Testing, Clear Stream
9	10	11 C.H.S. Bd. Meeting 8:00 p.m. Teacher Recognition Luncheon, Shaw	12 Teacher Recognition Luncheon Clear Stream & Forest	13	14	15 PTA Amblyopia Testing, Clear Stream
16	17	18 Teacher Recognition Day Art Exhibit Forest, 7:30 - 9 p.m.	19 PTA Installation Mtgs., Forest, 8:30 p.m. Shaw, 8:15 p.m.	20 Art Exhibit Clear Stream 7:30 - 9:00 p.m.	21	22
23	24 Bookmobile at Clear Stream	25 District No. 30 Bd. of Ed. Mtg., 8:15 p.m. Bookmobile at Clear Stream	26 Bookmobile at Clear Stream	27 Art Exhibit, Shaw 7:30 - 9:00 p.m. PTA Gen. Inst. Mtg. Clear Stream, 8:15 p.m.	28	29
30	31 SHAVUOT MEMORIAL DAY CELEBRATED	Efficiency of a practically flawless kind may be reached naturally in the struggle for bread. But there is something beyond — a higher point, a subtle and unmistakable touch of love and pride beyond mere skill; almost an inspiration which gives to all work that finish which is almost art — which is art. — Joseph Conrad				

SHAW AND WASHINGTON AVENUE SCHOOLS

CLASS MOTHER LIST

Grade Representative Coordinator Marie DiGiamo, LO 1-0079

Class Mother	Tel. Number	Teacher
Kindergarten Representative	Lonnie DiLuccio, LO 1-6837	
AM Mrs. Baier	VA 5-5829	Miss Blessinger
PM Mrs. Fenenbock	825-7419	Miss Blessinger
AM Mrs. DeStefano	285-4885	Mrs. Hartman
PM Mrs. Schlaeger	285-7588	Mrs. Hartman
Grade Representative	Anita Filosa, LO 1-0074	
Mrs. Kelly	825-0113	Mrs. Levine
Mrs. Jacobs	872-3144	Mrs. Harobin
Mrs. Ruggiero	CU 5-7603	Mrs. Kraft
Mrs. Ging	CU 5-6072	Mrs. Lazar
Grade Representative	Ruth Cohen, VA 5-4381	
Mrs. Cohen	VA 5-4381	Mrs. Eichlin
Mrs. Galante	CU 5-6507	Miss Bellini
Mrs. Ingargiola	CU 5-5162	Miss Cohen
Mrs. Napolitano	CU 5-6002	Miss Arnone
Grade Representative	Lillian Ging, CU 5-6072	
Mrs. Kelly	825-0113	Mrs. Sweet
Mrs. Field	VA 5-8581	Mrs. Erbig
Mrs. Short	825-5019	Mrs. Stevens
Mrs. Davis	872-3938	Miss Sharkey

Gr. Room	Class Mother	Tel. Number	Teacher
4th Grade Representative	Maureen Pascale, 825-0303		
4 106	Mrs. DiGiamo	LO 1-0079	Mrs. Stiefel
4 108	Mrs. Monti	CU 5-9378	Mrs. Kaplan
4 109	Mrs. Ging	CU 5-6072	Mrs. Barnaby
4 110	Mrs. Pena	825-0887	Mr. Riccobono
5th Grade Representative	Dee Robson, 825-0598		
5 114	Mrs. Diaz	CU 5-6126	Mrs. Wasserman
5 116	Mrs. Hadjiyane	CU 5-7434	Miss Schwartz
5 118	Mrs. Goldfischer	CU 5-6227	Mrs. Hamcke
5 122	Mrs. Zannatta	LO 1-8913	Mr. Beyer
6th Grade Representative	Ida Ierardi, CU 5-6047		
6 121	Mrs. Schlaeger	285-7588	Mrs. Squires
6 123	Mrs. Dickinson	CU 5-9496	Miss Lanell
6 124	Mrs. Filosa	561-0074	Mrs. Sherman
6 125	Mrs. Harmeyer	CU 5-9594	Mrs. Rosche
6 127	Mrs. Ierardi	CU 5-6047	Mr. Giacalone
Special Cl. 131	Mrs. D'Angelo	872-3551	Mrs. Krimko

JULY 1971

DAY	MONDAY	TUESDAY	WEDNESDAY	THURSDAY	FRIDAY	SATURDAY
can happen to a good man, either in life or after death.			— Socrates	1	2	3
the animals, the boy is the most unmanageable.			— Plato			
any man the world is as fresh as it was the first day, and as full of untold for him who has the eyes to see them.			— Thomas Henry Huxley			
4	5	6	7	8	9	10
DEPENDENCE		District No. 30 Reorganization Meeting				
11	12	13	14	15	16	17
		C.H.S. Bd. Meeting 8:00 p.m.				
18	19	20	21	22	23	24
25	26	27	28	29	30	31
		District No. 30				

CLEAR STREAM AVENUE SCHOOL

CLASS MOTHER LIST

Grade	Room	Class Mother	Tel. Number	Teacher
K (8:30)		Lorraine Duca	285-5112	Miss Starler
K (8:30)		Margie McGovern	CU 5-9011	Miss Starler
K (11:00)		Barbara Bevacqua	LO 1-8808	Miss Eden
K (11:00)		Marie Pascuzzi	VA 5-8401	Miss Eden
K (1:30)		Stephanie Klein	825-0151	Miss Eden
K (1:30)		Beverly Jablonowski	825-2489	Miss Eden
1	8	Julia Saginario	285-8670	Mrs. Riccobono
1	8	Marion Acquavella	825-2272	Mrs. Riccobono
1	B	Marie Cusumano	825-4956	Mrs. Schaaf
1	B	Lenore Egan	825-8975	Mrs. Schaaf
2	5	Rose LaRusso	872-8079	Mrs. Galati
2	5	Eleanor King	LO 1-6244	Mrs. Galati
2	6	Regina Schneider	872-8409	Mrs. Guberman
2	6	Stella Rusinyak	285-8094	Mrs. Guberman
2	7	Marie Cusumano	VA 5-4956	Mrs. Williams
2	7	Dolores O'Leary	VA 5-5943	Mrs. Williams
3	1	Dorothy Walz	825-8011	Miss Firpo
3	1	Helen Schwartz	LO 1-0405	Miss Firpo
3	2	Jo Ann Wood	285-9125	Miss Schindelman
3	2	Ann Prisco	CU 5-5744	Miss Schindelman
3	4	Terry Annarumma	CU 5-9336	Mrs. Quinn
3	4	Rose McMeekan	285-9820	Mrs. Quinn
4	25	Muriel Watterson	825-5478	Miss Yelland
4	25	JoAnn LaBarbera	285-9820	Miss Yelland
4	26	Hilda Flynn	825-6081	Miss Tracy
4	26	Marie LiRosi	285-8020	Miss Tracy
4	3	Jean Saverese	285-5116	Mrs. Heimowitz
4	3	Margie Croak	825-9352	Mrs. Heimowitz
5	23	Gloria Gargulio	825-4074	Miss Patterson
5	23	Marilyn Margolies	CU 5-8973	Miss Patterson
5	23	Ann Prisco	CU 5-5744	Miss Patterson
5	27	Gloria Corradi	CU 5-5255	Mrs. Lake
5	27	Peggy Carlson	CU 5-8857	Mrs. Lake
5	27	Jennie Tretola	LO 1-2527	Mrs. Lake
5	28	Mary Tragnor	CU 5-5902	Mrs. Gerdyk
5	28	Irene Wood	872-8627	Mrs. Gerdyk
5	28	Elena Cerenza	CU 5-5671	Mrs. Gerdyk
6	21	Doris Horowitz	825-2865	Mr. Cooper
6	21	Joan King	CU 5-9718	Mr. Cooper
6	21	Terry Keller	CU 5-7016	Mr. Cooper
6	22	Winifred Jones	CU 5-9757	Miss Melzer
6	22	Irene Kielawa	LO 1-1075	Miss Melzer
6	22	Joan Wood	872-3367	Miss Melzer
6	24	Arlene Cooper	825-7779	Mrs. Gropper
6	24	Kay Schmidt	872-8692	Mrs. Gropper
6	24	Marie Spitzfadden	285-6161	Mrs. Gropper

FOREST ROAD SCHOOL

CLASS MOTHER LIST

Class Mother Chairmen
Marcia Balaban and Ruth Misrok

Grade	Room	Class Mother	Tel. Number	Teacher
K	AM	201 Linda Zahn	791-4516	Miss Corin
K	AM	201 Sylvia Markowitz	791-1257	Miss Corin
*K	PM	201 Irene Bochner	791-6351	Miss Corin
K	PM	201 Judy Orloff	791-3820	Miss Corin
*1		203 Bonnie Kagan	561-7206	Miss Cafiso
1		203 Barbara Frumowitz	872-3655	Miss Cafiso
1		204 Judy Nadler	825-0247	Mrs. Lauria
1		204 Paulette Kirschenbaum	791-7045	Mrs. Lauria
*2		205 Corky Shaw	791-8807	Miss Perrich
2		205 Corinne Rosenholtz	872-3655	Miss Perrich
2		206 Marjorie White	791-5361	Miss Post
2		206 Rochelle Ladetsky	791-3995	Miss Post
3		207 Doris Bernanke	791-3790	Mrs. Cummings
3		207 Nina Weitzner	791-9615	Mrs. Cummings
*3		209 Lois Apfelbaum	791-4468	Miss Clarke
3		209 Lydia Rosen	791-5448	Miss Clarke
*4		210 Elaine Waldman	791-3140	Miss Bendin
4		210 Marcia Goldman	791-8929	Miss Bendin
4		211 Barbara Rovin	791-1360	Miss Nancken
4		211 Huguette Bruballa	825-2138	Miss Nancken
*5		212 Bernice Eisenberg	791-6792	Mrs. Caravaggio
5		212 Alice Eisbreuch	791-9161	Mrs. Caravaggio
5		214 Louise Printz	791-6951	Mrs. Bengtson
5		214 Joan Lewis	791-7312	Mrs. Bengtson
5		216 Olga Noto	791-2241	Mrs. Neuman
5		216 Gloria Slavin	791-7779	Mrs. Neuman
6		217 Barbara Fichtel	791-4187	Mrs. Kessler
6		217 Carolyn Green	791-7946	Mrs. Kessler
6		217 Estelle Glazer	791-5308	Mrs. Kessler
6		218 Beverly Brosterman	791-7021	Mrs. Melnick
6		218 Diane Kahn	791-4756	Mrs. Melnick
6		218 Lillian Spector	791-2627	Mrs. Melnick
*6		220 Pearl Lustbader	791-9854	Mr. Kaufmann
6		220 Phyllis Wolin	791-8120	Mr. Kaufmann
6		220 Barbara O'Reilly	791-4068	Mr. Kaufmann
6		220 Eileen Silver	791-2060	Mr. Kaufmann

*Grade Coordinator

AUGUST 1971

NDAY	MONDAY	TUESDAY	WEDNESDAY	THURSDAY	FRIDAY	SATURDAY
1	2	3	4	5	6	7
8	9	10 C.H.S. Bd. Meeting, 8:00 p.m.	11	12	13	14
15	16	17	18	19	20	21
22	23	24 District No. 30 Bd. of Ed. Mtg., 8:15 p.m.	25	26	27	28
29	30	31	Life is the art of drawing sufficient conclusions from insufficient premises. — Samuel Butler All progress is based upon a universal innate desire on the part of every organism to live beyond its income. — Samuel Butler			

**UNION FREE SCHOOL DISTRICT No. 30 AND
CENTRAL HIGH SCHOOL DISTRICT No. 1,
VALLEY STREAM, NEW YORK**

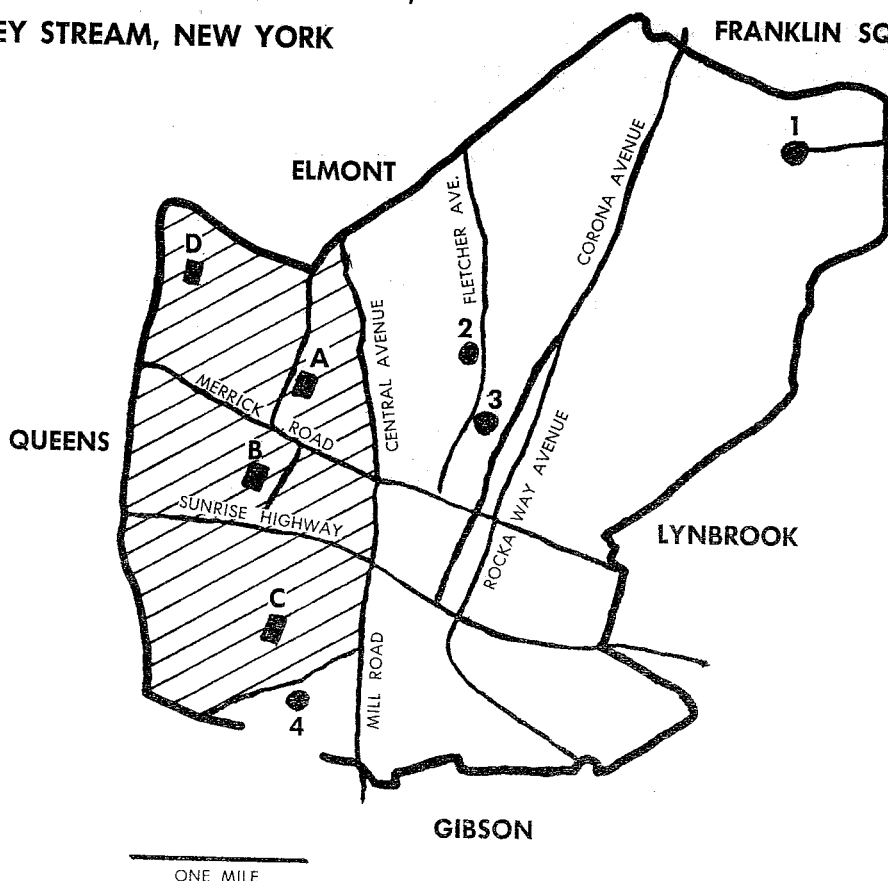

DISTRICT No. 30 SCHOOLS

- Shaw Avenue A
- Clear Stream Avenue B
- Forest Road C
- Washington Avenue D

Shaded Area — District 30

HIGH SCHOOLS

- North High 1
- Memorial Junior 2
- Central High 3
- South High 4

SCHOOL TELEPHONE DIRECTORY

OFFICE: SHAW AVENUE SCHOOL		Shaw Avenue School	
Principal	VA 5-9131	Principal's Office	VA 5-9131
Office	VA 5-9131	Nurse's Office	VA 5-9131
Manager	VA 5-9131		
Washington Avenue School		Washington Avenue School	
Office	VA 5-9131		
Special Services		Special Services	
Administrative Assistant/Curriculum	VA 5-6131	Psychologist	VA 5-9131
Psychologist	VA 5-9131	Speech Consultant	VA 5-9131
Speech Consultant	VA 5-9131	Reading Consultant	PY 1-7676
Reading Consultant	PY 1-7676	Audio-Visual Consultant	LO 1-1169
Audio-Visual Consultant	LO 1-1169		

INDEX

Board of Education and School Calendar see October

Administration and Special Services see November

Clear Stream PTA see December

Shaw and Washington Avenue PTA see January

Forest Road PTA see February

Safety for Youngsters is a Cooperative Affair see March

Educational School Systems — Valley Stream see April

School Policies see May and June

Shaw and Washington Class Mothers see July

Clear Stream and Forest Class Mothers see August

Map of the District see facing page

CENTRAL HIGH SCHOOL DISTRICT NO. 1
Telephone Number: VA 5-3642

Use this number for all high school buildings, offices and personnel

UNION FREE SCHOOL DISTRICT THIRTY

VALLEY STREAM NEW YORK

30

SCHOOL ACTIVITIES

Calendar

FOR 1971-1972

PUBLISHED BY THE BOARD OF EDUCATION AND PARENT/TEACHER ASSOCIATION

TELEPHONE DIRECTORY

INDEX

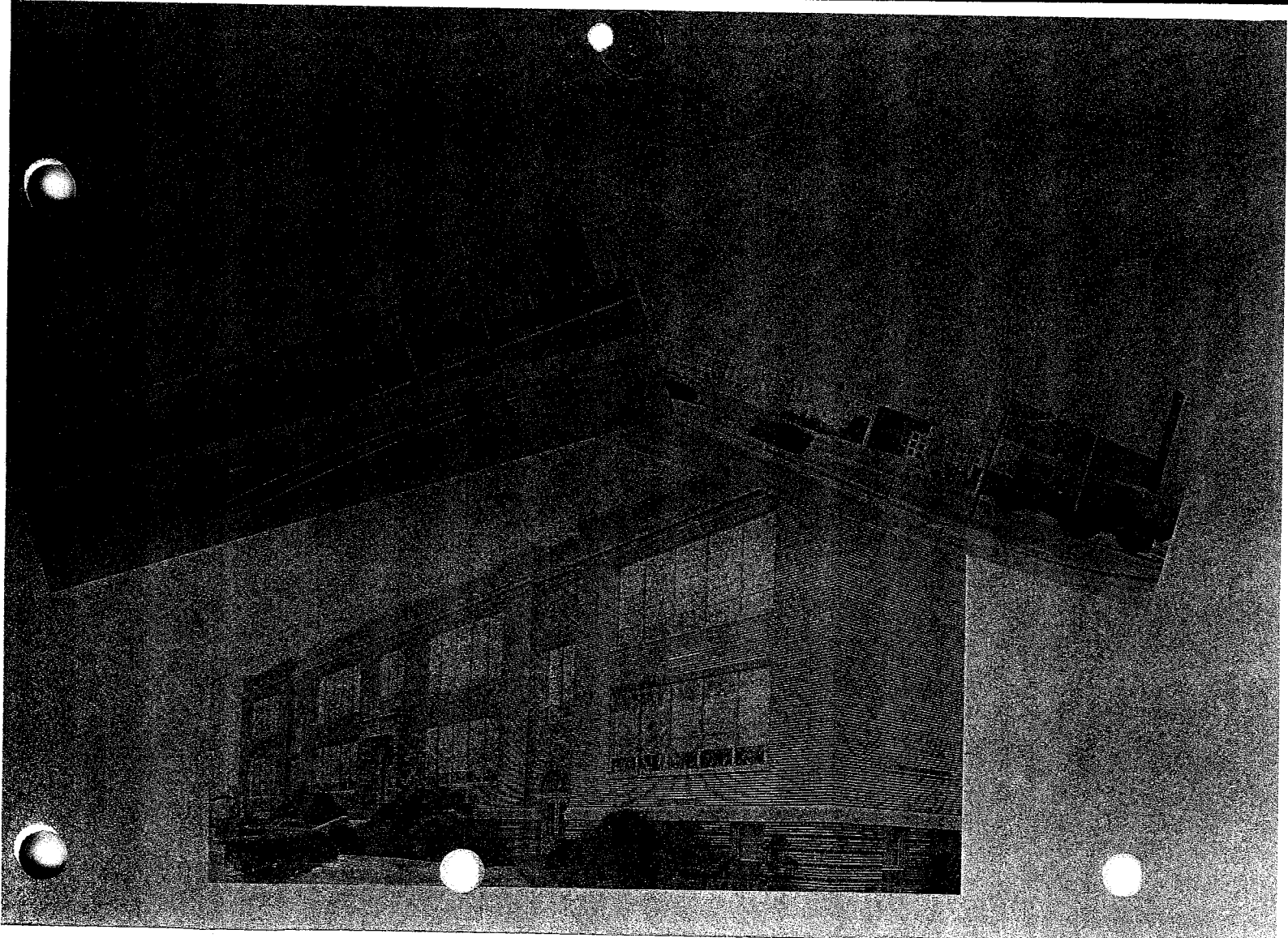

SEPTEMBER 1971

SUNDAY	MONDAY	TUESDAY	WEDNESDAY	THURSDAY	FRIDAY	SATURDAY
<p>... of emperors and cobblers are cast in the same ... the same reason that makes us wrangle with a ... our causes a war betwixt princes.</p> <p style="text-align: right;">— Montaigne</p>			1 PTA Ex. Bd. Mtg., Forest 8:30 p.m.	2	3	4
5	6 LABOR DAY	7 Faculty Meeting	8 SCHOOL OPENS PTA Book Cover Sale Clear Stream	9 PTA Book Cover Sale Clear Stream PTA Ex. Bd. Mtg., Clear Stream, 1:15 p.m.	10	11
12	13	14 Primary Day Noon - 9 p.m. C.H.S. Bd. of Ed. Mtg., 8:00 p.m. Parents' Night Wash. 8:15 p.m.	15 PTA Ex. Bd. Mtg. Shaw 1:00 p.m. Class Mother's Mtg. Forest 8:30 p.m. Parents' Night, Shaw (K-3) 8:15 p.m.	16	17	18
19	20 Rosh Hashanah SCHOOL CLOSED	21 Rosh Hashanah SCHOOL CLOSED	22 "Meet the Teacher" Night, Forest 8:30 p.m.	23 Parents' Night, Shaw (4-6) 8:15 p.m.	24	25 Bicycle Painting Forest 10:30 - Noon
26	27	28 Dist. No. 30	29 Yom Kippur SCHOOL CLOSED	30 PTA Parent's Night	<p>Be not angry that you cannot make others as you wish them to be, since you cannot make yourself as you wish</p>	

BOARD OF EDUCATION

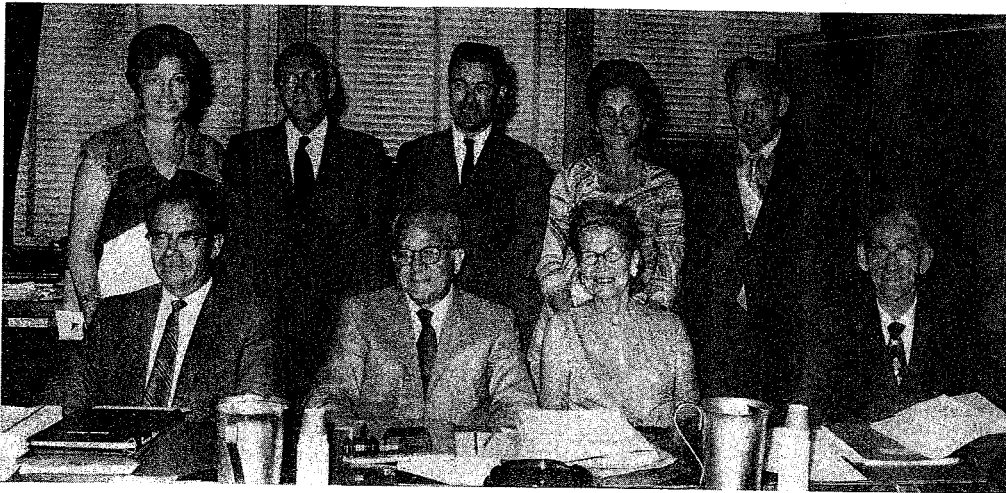

Standing (left to right): Eleanor Zeller, Board Clerk; George Adams, School Attorney; Joseph Barry; Eleanor Berger, Board Treasurer; Sherwood Quick, District Principal. Seated: James R. Smith*, Vice-president; Nathaniel Altschul*, Elinor McAuliffe*, President; Robert Bell.
 *Also serves on High School Board.

SCHOOL CALENDAR, 1971-1972

Meeting	Tues. Sept. 7	Winter Recess	School closes at regular time	Wed. Feb. 16
Open for Students	Wed. Sept. 8	Washington's Birthday	School Reopens	Mon. Feb. 21
Shashanah	Mon. & Tues. Sept. 20, 21	Easter Recess	School closes at regular time	Wed. Mar. 29
Chippur	Wed. Sept. 29	Memorial Day	School Reopens	Mon. April 10
Yom Kippur	Mon. Oct. 11	Last Day of School	School Closed	Mon. and Tues. May 29, 30
Yom Ha'atzma	Mon. Oct. 25			June 25
Shavuot	Schools close at end of morning session			
	Wed. Nov. 24			
	Schools Reopen			
	Mon. Nov. 29			
Chanukah	School closes at regular time			
	Thurs. Dec. 23			
	School Reopens			
	Mon. Jan. 3			

OCTOBER 1971

SUNDAY	MONDAY	TUESDAY	WEDNESDAY	THURSDAY	FRIDAY	SATURDAY
Now that fabrics are wrinkleproof, there remains the baffling problem of humans. Wrinkles should merely show where the smiles have been. — Mark Twain Try to save some money, if possible. Some day it may be valuable again. Inflation: Just a drop in the bucket.						
3	4 SUKKOT	5 SUKKOT PTA Parents' Night Clear Stream (4-6) 7:30 p.m.	6 PTA Ex. Bd. Mtgs., Forest 8:30 p.m. Shaw 1:00 p.m.	7 PTA Ex. Bd. Mtg. Clear Stream 1:15 p.m.	8 PTA Cultural Arts Assembly, Shaw	9 Candlelite Dinner and Auction Forest 8:00 p.m.
10	11 Eighth Day of SUKKOT COLUMBUS DAY SCHOOL CLOSED	12 Simhat Torah C.H.S. Bd. of Ed. Mtg., 8:00 p.m.	13	14	15	16
17	18	19 PTA Jelly Apple Sale Clear Stream	20 PTA Gen. Mtg. Forest 8:30 p.m. PTA Gen. Mtg. Shaw 8:15 p.m. PTA Jelly Apple Sale Clear Stream	21 PTA Gen. Mtg. Clear Stream 8:00 p.m.	22	23
24 Veterans Day SCHOOL CLOSED	25 VETERANS DAY SCHOOL CLOSED	26 Dist. No. 30	27 <i>C.S. London</i>	28	29 6th Gr. Hallowe'en Party, Forest	30

SCHOOL ADMINISTRATION

Dr. William T. Callahan, *District Superintendent*

Sherwood S. Quick
District Principal

SCHOOL PRINCIPALS

CLEAR STREAM AVENUE SCHOOL
Richard M. Burbell

FOREST ROAD SCHOOL
Maurice E. St. Mary

SHAW AVENUE SCHOOL
Lawrence Cid

William J. Van Ness, *Administrative Assistant/Curriculum*
George W. Niederhauser, *Administrative Assistant/Business*

SCHOOL SECRETARIES

Jeanne Feeney, *Clear Stream Avenue*
Mary McDowell, *Forest Road*
Jean Annona, *Shaw Avenue*

DISTRICT SECRETARIAL STAFF

Margaret Bradley Lucy Felice Helen Kuchler
Marie O'Connell Gloria Zweier Mary Ribando
Clythe Sanchez Caroline Young
Evelyn Pearn, *Cafeteria Manager*

DISTRICT SPECIALISTS AND SPECIAL TEACHERS

Frank DeMarco, *Director of Educational Communications*
Rosalyn Kessler, *Psychologist*
Estelle Friedman, *Psychologist*
Raydine Teicheira, *Speech Consultant*
Frances Pollet, *Speech Teacher*
Dolores Stein, *Foreign Language Consultant*
Henry Kohlmann, *Instrumental Music Teacher*
Instrumental Music Teacher to be appointed

OTHER SPECIALISTS AND SPECIAL TEACHERS

Clear Stream Avenue School

Cathleen Meneilly, *Special Counselor*
Louiseann Richter, *Reading Teacher*
Grace Giacobone, *Art*
Philip Hessemer, *Physical Education*
Joan Henningsen, *Physical Education*
Linda Pratt, *Music*
Ruth Newman, *Librarian*
Edna Giebel, *Nurse-Teacher*

Forest Road School

Special Counselor to be appointed
Ada Keaney, *Reading Consultant*
Linda Sleiertin, *Art*
Alfred Stevens, *Physical Education*
Joan Henningsen, *Physical Education*
Frances Gibson, *Music*
Rose Agree, *Librarian*
Hilda Rosenfeld, *Nurse-Teacher*

Shaw Avenue School

Noel Giambalvo, *Special Counselor*
Jeanne Colton, *Reading Specialist*
Rosemary Paradiso, *Reading Teacher*
Louise Holbrook, *Art*
Anita Lafayette, *Art*
Thomas Rouse, *Physical Education*
Joan Stein, *Physical Education*
Kathryn Egan, *Music*
Barbara Briker, *Music*
Sylvia Berkowitz, *Librarian*
Dorothy McCutchan, *Nurse-Teacher*

NOVEMBER 1971

SUNDAY	MONDAY	TUESDAY	WEDNESDAY	THURSDAY	FRIDAY	SATURDAY
	1	2 ELECTION DAY School in Session Voting 6 a.m. - 9 p.m. PTA Cake Sale Forest	3 PTA Ex. Bd. Mtgs. Forest 8:30 p.m. Shaw 1:00 p.m.	4 PTA Ex. Bd. Mtg. Clear Stream 8:00 p.m.	5	6
7	8 Inter-School PTA Ex. Bd. Mtg. Shaw	9 C.H.S. Bd. of Ed. Mtg. 8:00 p.m.	10 PTA Jelly Apple Sale Shaw	11 PTA Auction Sale Clear Stream 8:00 p.m.	12	13
14	15	16	17 Mental Health Wksp. Forest 8:30 p.m. Pre-School Mtg. Forest 3:00 p.m. Wksp., Clear Stream 1:30 p.m.	18	19	20 PTA Movie Shaw
21	22 Report Cards sent home	23 Dist. No. 30 Bd. of Ed. Mtg. 8:15 p.m.	24 SCHOOL CLOSURE 12:00 NOON	25 THANKSGIVING DAY SCHOOL CLOSED	26 SCHOOL CLOSED	27
28 SCHOOL REOPENS	29	30	We are all clever enough at envying a famous man while he is yet alive, and at praising him when he is dead. There was never any yet that wholly could escape love and never shall			

CLEAR STREAM AVENUE PARENT-TEACHER ASSOCIATION

ELECTED OFFICERS 1971-1972

President	Marilyn Margolies	285-9465
Co-President	Margaret Carlson	285-8857
First Vice President	Ann Docar	285-8914
Second Vice President	Marilyn Palazzo	872-3372
Treasurer	Mary Ammann	285-6090
Membership	Marie Pascuzzi	825-8401
	Hilda Flynn	825-6081
Recording Secretaries	Irene Wood	872-8627
Corresponding Secretary	Jennie Tretola	872-9527
Delegates to Council	Joan King	285-9718
	Elaine Gunderson	285-9307
	Mrs. Guberman	Faculty
Past President	Jeanette Ermiler	825-6368

COMMITTEE CHAIRMEN

Arts and Flyers	Joy Roccanova	285-8860
	Rose McMeekin	285-4925
Typing	Marge Croak	825-9352
	Gloria Gargulo	825-4074
Audio-Visual	Frank DeMarco	Faculty
Budget	Ruth Cornish	872-3020
Cultural Arts	Ruth Cornish	872-3020
Health	Kay Schneider Ann Planco	872 8610
Historian	Elena Cirenza	285-5671
Legislation	Jeanette Ermiler	825-6368
	Lois Barry	285-8654
Mimeographers	Mary Ammann	285-6090
	Rose McMeekin	285-9820
Pre-School	Marilyn Palazzo	872-3372
	Marie Li Rosi	285-8020
Program	Ann Docar	285-8914
School & Community	Edna Geibel	Faculty
	Pat Collins	285-8839
	Elaine Gunderson	285-9307
Safety	Irene Wood	872-8627
Sunshine	Ann Prisco	285-5754
THE STREAMER		
Editor	Muriel Watterson	825-5478
Distribution	Rose McMeekin	285-4925
Ways & Means	Kay Ciccone	LO 1-9207
	Connie Deering	285-6210
Bowling	Marie Spitzfadden	285-6161
	Marie Grande	LO 1-6310
	Terry Keller	285-7016
Hospitality	Marie Li Rosi	285-8020
	Stefanie Klein	825-0151
	Rose La Russo	872-8079
	Ann Finnazzo	285-6660
Publicity	Connie Deering	285-6210
Publications	Beverly Jablonowski	825-2489

Kindergarten Rep.	Rosemary Baker	285-9704
1st Grade Rep.	Beverly Jablonowski	825-2489
2nd Grade Rep.	Jean Savarese	285-5116
3rd Grade Rep.	Jo Ann La Barbera	285-9820
4th Grade Rep.	Mary Ammann	CU 5-6090
5th Grade Rep.	Mary Pascuzzi	825-8401
6th Grade Rep.	Ann Prisco	285-5754
6th Gr. Liaison Ch. C.M.	Ann Prisco	285-5754
Rep. P.T.A. Educa. Comm.		

P.T.A. PROGRAM

Sept.	8	Book Cover Sale
	9	Book Cover Sale; Executive Board Meeting—1:15 P.M.
	30	Parent's Night (K-3) 7:30 P.M.
Oct.	5	Parents' Night (4-6) 7:30 P.M.
	7	Executive Board Meeting—1:15 P.M.
	19	Jelly Apple Sale
	20	Jelly Apple Sale
	21	General Meeting—8:00 P.M.—Dr. Maitinsky of the Child Development Center at Meadowbrook—"Learning Disabilities of Children"
	27	Teacher Recognition Day
	29	Halloween Party—Fifth and Sixth Grades
Nov.	4	Executive Board Meeting—8:00 P.M.
	11	Auction Sale—8:00 P.M.
	17	Workshop—Demonstration of Fruits and Vegetables Garniture—1:30 P.M.
Dec.	2	Executive Board Meeting—8:00 P.M.
	7	Pre-School Meeting
	16	Holiday Assembly
Jan.	6	Executive Board Meeting—1:15 P.M.
	26	Workshop—Demonstration on the Art of Applying Make-up 1:30 P.M.
Feb.	3	Executive Board Meeting—1:15 P.M.
	9	Cake Sale
	16	Founders' Day—8:30 P.M.
Mar.	2	Executive Board Meeting—8:00 P.M.
	3	Father Son-Daughter Night—7:30 P.M.—"Mr. Jiggs"
	7	Pre-School Meeting
	16	General Meeting—8:00 P.M.—Nominations of Officers—Talk by Mrs. Green
	20	Sex Hygiene Meeting—Sixth Grade Parents—8:00 P.M.
	21	Sex Hygiene Meeting—Fifth Grade Girls—3:00 P.M.
	27	Sex Hygiene Meeting—Sixth Grade Girls and Boys—7:30 P.M.
Apr.	13	Executive Board Meeting—8:00 P.M.
	13	Registration for next year Kindergarten—(9:00-11:00 A.M.) Adelphi to test hearing
	28	Family Night at Clear Stream—Buffet Supper—"An Evening With Mr. DeMarco"—7:30 P.M.
May	4	Executive Board Meeting—1:15 P.M.
	6 & 13	Amblyopia Testing
	18	General Meeting & Installation of Officers—8:00 P.M.—Talent Group from Central
June	1	Joint Executive Board Meeting—8:00 P.M.

D E C E M B E R 1 9 7 1

DAY	MONDAY	TUESDAY	WEDNESDAY	THURSDAY	FRIDAY	SATURDAY
			1	2	3	4
			PTA Ex. Bd. Mtgs. Forest 8:30 p.m. Shaw 1:00 p.m.	PTA Ex. Bd. Mtg. Clear Stream 8:00 p.m.	PTA Holiday Square Dance Forest 7:30 p.m.	
5	6	7	8	9	10	11
		Pre-School Mtgs. Clear Stream Forest 8:30 p.m. Shaw & Wash. 3:00 p.m.			PTA Holiday Assembly Shaw 9 & 10 a.m. Forest 1:00 p.m.	
12	13	14	15	16	17	18
	HANUKKAH	C.H.S. Bd. of Ed. Mtg. 8:00 p.m.		PTA Holiday Assembly Clear Stream		
19	20	21	22	23	24	25
	Last day of Hanukkah	Dist. No. 30 Bd. of Ed. Mtg. 8:15 p.m.			Christmas Eve SCHOOL CLOSED	CHRISTMAS DAY
26	27	28	29	30	31	
	SCHOOL CLOSED	SCHOOL CLOSED	SCHOOL CLOSED	SCHOOL CLOSED	SCHOOL CLOSED	

SHAW AND WASHINGTON AVENUES PARENT TEACHER ASSOCIATION

ELECTED OFFICERS 1971-1972

ident	Lillian Fayet	561-6973
President	Jean Layden	285-7624
President	Anita Filosa	LO 1-0074
Secretary	Grace Pisano	872-3097
Recording Secretary	Marilyn D'Angelo	872-3567
Public Secretary	Louise Kiel	CU 5-9651
Responding Secretary	Diane Keenan	CU 5-6068
Messages to Council	Lillian Ging	CU 5-6072
	Janet Cohen	Faculty

COMMITTEE CHAIRMEN

Audio-Visual	John Giacalone	Faculty
Art	Stella Schlaeger	CU 5-7588
Band	Ann Buonasera	CU 5-9709
Cultural Arts	Kay Hadjiyane	CU 5-7434
Children's Theatre	Lillian Field	VA 5-8581
Contribution	Vita Caposella	285-6160
Elementary Rep. Coordinator	Marie DiGiamo	LO 1-0079
Elementary	Jean Davis	872-3938
Health and Safety	Grace Pisano	872-3097
Intelligence	Jean Yocono	VA 5-0728
Organization	Diane Keenan	CU 5-6068
Membership	Stella Schlaeger	CU 5-7588
Physical Health	Marie Casale	825-7872
Program	Gloria Zweier	825-9001
Publicity	Jean Layden	285-7624
Parent Education	Lillian Ging	CU 5-6072
Elementary	Stella Schlaeger	CU 5-7588
School	Cathy Dwyer	CU 5-5283
	Rita Dolan	CU 5-6008
	Judith Blessinger	Faculty
	Anita Filosa	LO 1-0074
	Susan Jacobs	872-3144
	George & Stella Schlaeger	CU 5-7588
	Louise Kiel	CU 5-9651
	Grace Pisano	872-3097
	Jean Layden	285-7624
	Lonnie DiLuccio	LO 1-6837

Kindergarten Rep.	Ginny Kropas	872-8117
1st Grade Rep.	Lonnie DiLuccio	LO 1-6837
2nd Grade Rep.	Anita Filosa	LO 1-0074
3rd Grade Rep.	Ruth Cohen	VA 5-4381
4th Grade Rep.	Lillian Ging	CU 5-6072
5th Grade Rep.	Maureen Pascale	825-0303
6th Grade Rep.	Dee Robson	825 0598

P.T.A. PROGRAM

Sept.	14	Parents' Night—Washington Ave.—8:15 P.M.
	15	Executive Board Meeting—1:00 P.M.
		Parents' Night—Shaw Ave.—K to 3—8:15 P.M.
	23	Parents' Night—Shaw Ave.—4 to 6—8:15 P.M.
Oct.	6	Executive Board Meeting—1:00 P.M.
	8	Cultural Arts Assembly
	20	General Meeting (Mental Health)—8:15 P.M.
	28	Teacher Recognition Day—Luncheon—Shaw
Nov.	3	Executive Board Meeting—1:00 P.M.
	8	Inter-School Meeting
	10	Jelly Apple Sale
	20	Movie
Dec.	1	Executive Board Meeting—1:00 P.M.
	7	Pre-School Meeting—Wash. & Shaw Ave.—3:00 to 3:30 P.M.
	10	Holiday Assembly for Children
Jan.	5	Executive Board Meeting—1:00 P.M.
	12	General Meeting—(Parent Ed.)—Afternoon
	18	Pre-School Meeting—Wash. & Shaw Ave.—3:00 to 3:30 P.M.
Feb.	16	Founders' Day (Clear Stream Avenue School)
Mar.	1	Executive Board Meeting—1:00 P.M.
	7	Pre-School Meeting—Wash. & Shaw Ave.—3:00 to 3:30 P.M.
	15	Cup Cake Sale
	29	Holiday Assembly for Children
April	12	Executive Board Meeting—1:00 P.M.
	20	Sex Hygiene Meeting—Fathers & 6th Grade Boys—8:00 P.M.
	24	Sex Hygiene Meeting—Mothers—1:00 P.M.
	26	Sex Hygiene Meeting—5th Grade Girls—3:00 P.M.
	28	Sex Hygiene Meeting—6th Grade Girls—3:00 P.M.
May	4	Executive Board Meeting—1:00 P.M.
	13	Amblyopia Testing
	17	Installation Night
June	7	Joint Board Meeting—1:00 P.M.

JANUARY 1972

SUNDAY	MONDAY	TUESDAY	WEDNESDAY	THURSDAY	FRIDAY	SATURDAY
						1 NEW YEAR'S DAY
2	3 SCHOOL REOPENS	4	5 PTA Ex. Bd. Mtgs. Forest 8:30 p.m. Shaw 1:00 p.m.	6 PTA Ex. Bd. Mtg. Clear Stream 1:15 p.m.	7	8
9	10	11 C.H.S. Bd. of Ed. Mtg. 8:00 p.m.	12 PTA Gen. Mtg. Shaw afternoon	13	14	15
16	17	18 Pre-School Mtg. Shaw & Wash. 3:00 p.m.	19 PTA Gen. Mtg. Norman Pollard Forest 8:30 p.m. Pre-School Mtg. Forest 2:00 p.m.	20	21	22
23	24	25	26	27	28	29
30	31 Dist. No. 30 Bd. of Ed. Mtg.	31	PTA Workshop Clear Stream			

FOREST ROAD PARENT TEACHER ASSOCIATION

ELECTED OFFICERS 1971-1972

President	Renee Pepper	791-3857
First Vice President	Nancy Cesta	791-8028
Second Vice President	Marsha Balaban	791-3627
Third Vice President	Judy Orloff	791-3820
Fourth Vice President	Phyllis Wolin	791-8120
Treasurer	Doris Bernanke	791-3790
Financial Secretary	Barbara Rovin	791-1360
Recording Secretary	Linda Zahn	791-4516
Corresponding Secretary	Selma Singer	791-3592
Delegate to Council	Eleanor Klein	791-3060

COMMITTEE CHAIRMEN

Amblyopia	Abbey Tedesco	791-2157
	Ruth Bazil	791-8556
Budget	Rochelle Ladetsky	791-3995
Class Mothers	Marlyn Fogel	791-4701
	Diane Kahn	791-4756
Ecology	Phyllis Wolin	791-8120
	Anita Strelisker	791-7167
Family Living	Florence Goldberg	791-7746
Flyers	Evelyn Grabois	791-1604
	Dotty Singer	791-9631
Goodwill	Madelaine Margolies	791-5097
Hospitality	Ginnie Levine	872-9165
	Sonia Berti	561-2878
	Linda Jones	791-5816
Historian	Rochelle Ladd	791-5049
Health & Safety	Florence Avron	791-3631
	Jeannie Stone	791-7182
Legislation	Ginnie Levine	872-9165
Membership	Barbara Rovin	791-1360
Mimeograph	Edith McGee	LO 1-7064
	Bea Spector	791-5216
Music & Art	Norma Kronenberg	791-3184
	Lois Apfelbaum	791-4468
Newsletter	Terry Dratler	791-7211
Parent Education	Phyllis Abelow	791-7951
	Sylvia Markowitz	791-1257
Parliamentarian	Donald Pepper	791-3857
Posters	Marilyn Sparber	791-5838
Pre-School	Judy Orloff	791-3820
Publicity	Catherine Pappas	791-2608
School Bd. Rep. - Elem.	Ruth Misrok	791-2597
	Phyllis Abelow	791-7951
Teachers Rep.	Blossom Melnick	O 1-6468
Typist	Ann Berger	791-4088

Ways & Means

Bowling	Nancy Cesta	791-8028
	Barbara O'Reilly	791-4068
Casserole Dinner	Paulette Kirschenbaum	791-7045
	Shelly Koval	791-1232
Square Dance	Pearl Lustbader	791-9547
	Marcia Goldman	791-8929
	Corky Shaw	791-8807
Carnival	Phyllis Wolin	791-8120
	Anita Strelisker	791-7167
Home Tour	Marcia Horowitz	791-3529

P.T.A. PROGRAM

Sept.	1	Executive Board Meeting—8:30 P.M.—Rene Pepper's
	15	Class Mother Meeting—8:30 P.M.
	22	Meet the Teacher Night—8:30 P.M.
	25	Bicycle Painting—10:30 - 12:00 Noon—Parking Field
Oct.	6	Executive Board Meeting—8:30 P.M.
	9	Candlelite Dinner and Country Auction—8:00 P.M.
	20	Meet Your Specialists Night—8:30 P.M.
	29	6th Grade Halloween Party
Nov.	2	Election Day Cake Sale
	3	Executive Board Meeting—8:30 P.M.
	17	Meet Mary Green (Mental Health Meeting)—8:30 P.M.
		Pre-School Meeting—3:00 P.M.
Dec.	1	Executive Board Meeting—8:30 P.M.
	3	Holiday Square Dance—7:30 P.M.—Parents and Children
	7	Pre-School Meeting—2:00 P.M.
	10	Holiday Program—Ballet—1:00 P.M.
Jan.	5	Executive Board Meeting—8:30 P.M.
	19	"Help Your Child Remember" Norman Pollard—8:30 P.M.
		Pre-School Meeting—2:00 P.M.
Feb.	2	Executive Board Meeting—8:30 P.M.
	15	Pre-School Meeting—3:00 P.M.
Mar.	1	Executive Board Meeting—8:30 P.M.
	15	Science Fair—8:30 P.M.
	22	Pre-School Meeting—2:00 P.M.
April	12	Executive Board Meeting—8:30 P.M.
	18	Pre-School Meeting—3:00 P.M.
	19	Walking House Tour—1:00 P.M.
	22	Carnival
	26	Gymnastics Fair—7:30 P.M.
May	3	Executive Board Meeting—8:30 P.M.
	10	Teachers Recognition Day Luncheon
	17	Installation of Officers—Music Fair—8:00 P.M.
June	7	Joint Board Meeting—8:30 P.M.

There will be a Bowling League from Forest Road that will meet on Mondays at the Green Acres Bowling Alley beginning in September between the hours 1:00 and 3:00 P.M.

FEBRUARY 1972

SUNDAY	MONDAY	TUESDAY	WEDNESDAY	THURSDAY	FRIDAY	SATURDAY
ence is that inestimable quality rse that keeps it from betting an. begins great works; labor nishes them. — Joseph Joubert		1	2	3	4	5
6	7	8	9	10	11	12
		C.H.S. Bd. of Ed. Mtg. 8:00 p.m.	PTA Ex. Bd. Mtg. Forest 8:30 p.m.	PTA Ex. Bd. Mtg. Clear Stream 1:15 p.m.		LINCOLN'S BIRTHDAY
13	14	15	16	17	18	19
		Pre-School Mtg. Forest 2:00 p.m.	ASH WEDNESDAY PTA Founders' Day Mtg., all schools at Clear Stream 8:30 p.m.	SCHOOL CLOSED WINTER RECESS	SCHOOL CLOSED WINTER RECESS	
20	21	22	23	24	25	26
	WASHINGTON'S BIRTHDAY SCHOOL CLOSED	SCHOOL REOPENS Dist. No. 30 Bd. of Ed. Mtg. 8:15 p.m.				
27	28	29	Thirty days hath September, April, June, and November; All the rest have thirty-one, Except February alone, Which hath twenty-eight, in fine.		America has furnished to the world the character of Washington. And if our American institutions had done nothing else, that alone would have entitled them to the respect of mankind	
		PURIM				

WHO WANTS TO SERVE ON THE BOARD OF EDUCATION?

As there seems to be confusion in the minds of some people regard to the composition of your Board of Education, we are devoting this page to that topic.

The Board of Education in District Thirty is composed of five members, each elected for a period of five years. Board of Education Trustees serve *without* pay and devote most of their free time to Board activities.

In addition to the regular Board meetings (which are usually the fourth Tuesday of each month), there are innumerable other nights devoted to Board activities which occupy a Board Trustee's time. Among these are negotiation meetings with the various groups of school employees (teacher, administrative, custodial and office staffs) which in some cases can take at least one night a week for ten to fifteen weeks, or longer; meetings of the Nassau-Suffolk School Boards Association; budget preparation meetings; budget hearings; the annual budget vote; High School Board meetings for three Trustees from District Thirty; The Board of Cooperative Educational Services meetings for one Trustee; meetings of the various Board committees throughout the year; and a host of other activities which use up what might be free time for most other people.

The background of each Board member may be of some interest to you. Mrs. Elinor McAuliffe is a homemaker living in the Forest Road area and a graduate of the Maxwell Teachers Training School in Brooklyn. Dr. Robert Bell is president of Lucius Pitkin, Incorporated, a firm of consulting chemists and metallurgists, and resides in the Clear Stream Avenue area.

Mr. Nathaniel Altschul is president of Altschul-Batterson Company, Incorporated, an insurance firm, and lives in the Forest Road area. Mr. James R. Smith is a professional engineer and an associate in the firm of Cafarelli Associates, Consulting Engineers, and resides in the Shaw Avenue area. Mr. Joseph M. Barry is Assistant Director of Family Services in the Nassau County Department of Social Services, is a certified social worker, and lives in the Clear Stream area.

School Board membership is demanding and challenging in its opportunity to consider and make decisions about this very vital area of government service. It is rewarding in the sense of having rendered civic service of the highest order. It also can be difficult and thankless in that Board members may sometimes find themselves pressured by proposals and complaints.

District Thirty has indeed been fortunate in-so-far as time and again loyal and civic-minded people have stepped forward and served on the Board. Any progress we have made is due to their forward and tireless efforts.

BOARD MEMBERS	TERM EXPIRES
Elinor McAuliffe	1972
Robert Bell	1973
James R. Smith	1974
Joseph M. Barry	1975
Nathaniel Altschul	1976

MARCH 1972

SUNDAY	MONDAY	TUESDAY	WEDNESDAY	THURSDAY	FRIDAY	SATURDAY
			1	2	3	4
			PTA Ex. Bd. Mtgs. Forest 8:30 p.m. Shaw 1:00 p.m.	PTA Ex. Bd. Mtg. Clear Stream 8:00 p.m.	PTA Father-Son-Daughter Night, Clear Stream 7:30 p.m.	
5	6	7	8	9	10	11
		Pre-School Mtg. Clear Stream & Shaw 3:00 p.m.				
12	13	14	15	16	17	18
		C.H.S. Bd. of Ed. Mtg. 8:00 p.m.	Science Fair Forest 8:30 p.m. Cupcake Sale, Shaw	PTA Gen. Mtg. Clear Stream 8:00 p.m.	St. Patrick's Day	
19	20	21	22	23	24	25
	Sex Hygiene Mtg. 6th Grade Parents Clear Stream 8:00 p.m.	Sex Hygiene Mtg. 5th Grade Girls Clear Stream 3:00 p.m.	Pre-School Mtg. Forest 2:00 p.m.		Annual Dist. Music Concert, Shaw 8:15 p.m.	
26	27	28	29	30	31	
SUNDAY	Sex Hygiene Mtg. 6th Gr. Girls & Boys	Dist. No. 30 Bd. of Ed. Mtg.	PTA Assembly for children. Shaw	First Day of Passover SCHOOL CLOSED EASTER RECESS	GOOD FRIDAY SCHOOL CLOSED	

TIME DOES NOT STAND STILL

District Thirty schools are changing. Whether we like it or not, change takes place constantly. If we ignore it, we are apt to be left standing alone while the rest of the world passes us by. This is true of many things—education in particular.

In District Thirty, we endeavor to keep up to these changes. In case in point—two teacher committees, which included some parents, were functioning this past school year and spent much time studying individualization of instruction and the use of Learning Centers, respectively. Out of these committees have come recommendations which are being implemented this coming school year.

Clear Stream Avenue School will begin the school year with a renovated library and Learning Center located on the second floor of the building, which will not only house books but listening posts (carrels) where pupils can do individual work using a variety of audio-visual aids such as film-strips, record players, tape recorders, transparencies and picture files—name only a few. In the other schools, Forest Road and Shaw Avenue, small areas have been set aside for these carrels, to be used in the same way as at Clear Stream Avenue School. If proven of great worth this school year, consideration will be given to expanding the program in the future.

Several teachers tried different techniques to individualize instruction this past year and most were quite enthusiastic about the results. Because of these trials, and because the committee on individualization has made several strong recommendations, we foresee that more and more teachers will move in this direction in this school year.

Several pilot programs have been initiated in the district

this past year, among them being a reading program in the fifth grades wherein pupils are grouped across the grade; a new science program was tried in all first grades throughout the district which allowed the pupils to observe various phenomena and to make judgments based on what they saw. This program will be added to the second grades this year (SCIS).

For years, the philosophy in reading was for the reading teacher to take pupils out of the classrooms for remedial help. This coming year, the reading specialists will do the remedial work in the classrooms for most pupils. In this way, through the close cooperation of the reading personnel and the classroom teacher, awareness of childrens' needs and how to meet them will be paramount.

New things are happening in many other schools in the area. To keep up to these programs, many of our teachers and administrators visited these other schools this past year and have brought back many ideas and techniques to better our own programs. Attendance at educational conferences served the same purposes.

Because of the obvious need for it, one of our teachers, who taught a half-day kindergarten class, has spent the other half-day working with the first grade pupils who were deficient in language development by providing them with meaningful experiences and training in needed skills.

Many of our teachers have taken inservice courses in drug education and mathematics this past school year thus helping to better our offerings to the pupils in these areas of instruction.

Time does not stand still and neither does District Thirty. Changes are being made, or contemplated, to better our educational program for the good of all the pupils.

APRIL 1972

DAY	MONDAY	TUESDAY	WEDNESDAY	THURSDAY	FRIDAY	SATURDAY
	Hide those hills of snow, thy frozen bosom bears, se tops the pinks that grow nose that April wears! set my poor heart free in those icy chains by thee. — Shakespeare	How many million Aprils came Before I ever knew How white a cherry bough could be, A bed of squills, how blue! — Sara Teasdale		May never was the month of love, For May is full of flowers; But rather April, wet by kind, For love is full of showers. — Robert Southwell		1
2	3	4	5	6	7	8
SUNDAY	SCHOOL CLOSED	SCHOOL CLOSED	Seventh Day of Passover SCHOOL CLOSED	Eighth Day of Passover SCHOOL CLOSED	SCHOOL CLOSED	
9	10	11	12	13	14	15
	SCHOOL REOPENS	C.H.S. Bd. of Ed. Mtg. 8:00 p.m.	PTA Ex. Bd. Mtgs. Forest 8:30 p.m. Shaw 1:00 p.m.	PTA Ex. Bd. Mtg. Clear Stream 8:00 p.m.		
16	17	18	19	20	21	22
		Pre-School Mtg. Forest 3:00 p.m.	PTA Walking House Tour, Forest	Sex Hygiene Mtg. Fathers & 6th Gr. Boys, Shaw, 8:00 p.m.	Reg. for next year's Kindergarten, each school, 9-11 a.m.	PTA Carnival, Forest Reg. for school voting 7 a.m. to 12 noon each school
23	24	25	26	27	28	29
	Sex Hygiene Mtg. Mothers of 5th &	Dist. No. 30	Forest Phys. Ed. Fair, 7:30 p.m.; Report Cards sent home; Sex Hygiene Mtg.,	Reg. for school voting	Fam. Night, buffet supper, Clear Stream 7:30 p.m.; Sex Hygiene	

SCHOOL POLICIES

SCHOOL HOURS

hours for grades 1, 2, and 3 are from 9:00 a.m. to 3:00 p.m.
 hours for grades 4, 5, and 6 are from 8:30 a.m. to 2:45 p.m.

LUNCH

Lunch is served beginning with the first day of school. Pupils go home for lunch, bring lunch from home, or buy the school lunch in the cafeteria for 35c. Monthly menus are provided so that if foods are served which your child does not eat, you can make other provisions for him for those days. In case a child forgets his lunch money or his lunch, or loses either, we have a cash system to cover the emergency. The cashier in the cafeteria keeps the record of such charges and contacts the parents if a charge not be paid in a reasonable time.

ICE CREAM

Ice cream is sold daily to those pupils who wish it. It is *not* sold with the hot lunch and costs an additional 10c.

RECESS MILK

Recess milk is available to all children beginning about the first week of the school year and is sold at a cost of 15c per week payable each Thursday for the following week. You will be billed as to the exact date. Money brought in late (Friday) cannot be accepted. In case of a child's absence, no refund is made for periods of less than a full week.

ABSENCES

If your child has been absent, State law requires that he give a note from you explaining the absences and the date(s) of absence(s). The note should be presented to the nurse *before* he goes to the classroom. Please be specific. Just saying, "he was sick," is not enough. Indicate whether it was "virus," "fever," "cold," etc. A note is required for an absence due to a religious holiday. A note is required for any tardiness, giving the reason. If your child contracts a contagious disease, such as mumps, measles, etc., please phone the school nurse so that she can contact the parents in your child's class that their children have been exposed. Be sure to keep the emergency card up to date so that we will know whom to call should your child become ill and need to go home.

NOON HOUR RULES

When pupils misbehave in the cafeteria, auditorium, or on the playground during the noon hour, after repeated reminders, the teachers have the authority to exclude them from staying in school for lunch for a few days, or longer, depending on the misbehavior. If you receive such a note from us, we would appreciate your cooperation. Whether or not a mother is home during the noon hour has no bearing on this exclusion.

RELEASED TIME FOR RELIGIOUS INSTRUCTION

A Release Form signed by the parent is necessary should you want your child excused from school for religious instruction. Such forms can be obtained from your church. The time provided is the last hour of school on Wednesday afternoons.

EXITS AND ENTRANCES

Your child's class is assigned a specific exit and entrance to use. You will thus know where to meet him if you come to pick him up. Parents picking up children are asked to meet them at the exit, *not* the classroom.

ENTRANCE TIMES

Morning — All Schools	Noontime — Shaw & Forest
Grades 1, 2, & 3 — 8:50	Grades 1, 2, & 3 — 12:50
Grades 4, 5, & 6 — 8:20	Grades 4, 5, & 6 — 12:20
Noontime—Clear Stream: Grades 5 & 6—12:05	
Grades 3 & 4—12:35; Grades 1 & 2—1:05	

Because there is no supervision of the playground in the morning, we suggest you arrange your child's departure from home to allow him to arrive just in time to enter the building during the proper interval. In inclement weather he may come into the designated area five minutes before the above times.

CLASS INTERRUPTIONS

No unnecessary interruptions of classes are allowed once the day's sessions have begun. When your child forgets a book, homework, sneakers, lunch money, etc., please bring these to the office. All pupils are instructed to check with the office at lunch time for such forgotten items. In the interest of the child's all-round education, we urge you not to make a practice of bringing forgotten items to school. The child should be developing his own sense of responsibility for these things.

MAY 1972

SUNDAY	MONDAY	TUESDAY	WEDNESDAY	THURSDAY	FRIDAY	SATURDAY
	1	2	3 Voting on School Budget 7:00 a.m. to 10:00 p.m. All Schools PTA Ex. Bd. Mtg. Forest 8:30 p.m.	4 PTA Ex. Bd. Mtg. Clear Stream 8 p.m. Shaw 1:00 p.m.	5	6 PTA Amblyopia Testing, Clear Stream
7	8	9 C.H.S. Bd. of Ed. Mtg. 8:00 p.m.	10 Teachers Recognition Day Luncheon, Forest	11	12	13 PTA Amblyopia Testing, Clear Stream
14 Teacher's Day	15	16 Art Exhibit Clear Stream 7:30 to 9:00 p.m.	17 PTA Installation Mtg. Forest & Shaw 8:00 p.m.	18 Art Exhibit, Forest 7:30 to 9:00 p.m. PTA Gen. Mtg. Clear Stream 8 p.m.	19 SHAVOUT	20 SHAVOUT
21	22	23 Dist. No. 30 Bd. of Ed. Mtg. 8:15 p.m.	24	25 Art Exhibit Shaw & Washington 7:30 to 9:00 p.m.	26	27
28	29 MEMORIAL DAY SCHOOL CLOSED	30 SCHOOL CLOSED	31	Hard is the herte that loveth nought in May. — Chaucer May is building her house. With apple blooms She is roofing over the glimmering rooms.		

SCHOOL POLICIES

GYM SUITS AND SNEAKERS

Gym suits are required of pupils below the 3rd grade, but sneakers are necessary for any pupils using the gym. Boys and girls from the 3rd through 6th grades are required to wear gym suits and sneakers on the assigned gym days. The gym teachers explain this to the pupils, but many times they do not bring correct information home.

Who **MUST PURCHASE A NEW SUIT** should buy the piece **ROYAL BLUE**, bloomer type, with elastic bottoms, or **ROYAL BLUE** shorts with elastic insert in the cuff, and a white t-shirt. Boys should wear **ROYAL BLUE** shorts, with elastic top, and sneakers (high top ones preferred), and white or **SCHOOL "T"** shoes.

A CHILD HAS ANOTHER COLOR, OR TYPE, HE DOES NOT HAVE TO BUY A NEW ONE. The above apparel may be purchased at many local stores in Valley Stream. **NO ONE IS ALLOWED ON THE GYM FLOOR WITHOUT SNEAKERS.**

APPOINTMENTS WITH TEACHERS

In order that pupils' classtime be used to the fullest advantage, we request that parents do not seek conferences with teachers during school hours. If you wish a conference, please make an appointment to see the teacher after school. Teachers are available for such conferences every day except Mondays and Fridays.

BICYCLES

Bicycles are allowed at either Forest Road or Clear Stream Avenue Schools because no child lives far enough from the school to make them necessary. They are allowed at Shaw, but are restricted to pupils in grades 4, 5, and 6 who live **NORTH OF CLEAR AVENUE**. Bicycles used to come to the Shaw Avenue School will be assigned a number. All must have a lock and a bell for safety purposes.

GIFTS TO TEACHERS PROHIBITED

Policy of the school district which became effective January 1, 1956, is to prohibit the acceptance of gifts by faculty members on school premises, and to prohibit the solicitation of funds for personal gifts purposes, by any person, or persons, on the premises.

IN-DAY PROGRAM

In inclement weather, there is an in-day program of motion pictures provided for those pupils who eat in the cafeteria. Pupils who go home to lunch are not allowed to participate in this program because of space limitations, so we ask parents to return these pupils to school on such days just in time for the afternoon session—not before 12:50 p.m. for grades 1 to 3, and 12:20 p.m. for grades 4 to 6 at Shaw and Forest; and not before 12:05 for grades 5 and 6, 12:35 for grades 3 and 4, and 1:05 for grades 1 and 2 at Clear Stream.

HOMEWORK REQUIREMENTS

Homework is required of all pupils, but it will vary from day to day. First and second grade pupils may have fifteen to twenty minutes of homework per day, while third and fourth grade pupils are likely to have thirty to forty minutes. Fifth and sixth graders are expected to devote as much as an hour to homework, but again this may not be every day—it will depend on the pupil and his needs.

LOST AND FOUND

Unmarked articles lost by pupils are placed in the Lost-and-Found, which is in the Nurse's Office at Shaw & Forest, and the custodian's office at Clear Stream. Such articles, if not claimed at the end of the school year, are given to a charitable organization. However, any article bearing a child's name is returned directly to him. Please place your child's name on all his belongings.

STAYING AFTER SCHOOL

To eliminate any confusion or problems, the school may have your child every day for an additional half hour. During this half hour beyond the regular school day, the teacher may schedule your child for special help or keep him for any of several reasons. We ask that you keep this in mind and not schedule dental appointments, dancing lessons, etc. until after that interval. Teachers are also available to parents during the half hour after school, except on Monday and Friday, for conferences. Appointments are not necessary, but it is to your advantage to make one.

ASSEMBLIES

When your child's class puts on the assembly, we welcome your attendance, but we do ask you not to bring pre-school children. As much as we realize that it is a thrill for them to see a big brother perform, they are often distracting to a concerned parent.

JUNE 1972

DAY	MONDAY	TUESDAY	WEDNESDAY	THURSDAY	FRIDAY	SATURDAY
1 of brooks, of blossoms, birds, and : May, of June, and July-Flowers of May-poles, Hock-carts, was-sails,		Tell you what I like best— 'Long about knee-deep in June, Bout the time strawberries melts On the vine,—some afternoon Like to jes' git out and rest, And not work at nothin' else. — John Whitcomb Riley		1 PTA Joint Ex. Bd. Mtg., Clear Stream 8:00 p.m.	2	3
4 grooms, brides, and of their kes.	5 — Robert Herrick	6	7 PTA Joint Ex. Bd. Mtgs., Forest 8:30 p.m. Shaw 1:00 p.m.	8	9	10
11	12	13 C.H.S. Bd. of Ed. Mtg. 8:00 p.m.	14 FLAG DAY	15	16	17
18 S DAY	19	20	21 Closing Exercises for 6th Grade	22	23 LAST DAY OF SCHOOL	24
25	26 Annual School Census Begins	27 Dist. No. 30 Bd. of Ed. Mtg.	28	29	30	

CLEAR STREAM AVENUE SCHOOL

CLASS MOTHER LIST

Grade	Room	Class Mother	Tel. Number	Teacher
*Kindergarten Representative Rosemary Baker, 285-9704				
K Morning		Maryann Gokey	285-7358	Miss Eden
K Morning		Marie Reilly	285-5109	Miss Eden
K Afternoon		Kathleen Angrisani	872-8683	Miss Eden
K Afternoon		Madeline Weiss	825-1719	Miss Eden
*1st Grade Representative Beverly Jablonowski, 825-2489				
1	B	Lorraine Duca	285-5112	Mrs. Schaaf
1	B	Rose La Russo	872-8079	Mrs. Schaaf
1	7	Barbara Bevacqua	LO 1-8808	Mrs. Lauria
1	7	Beverly Jablonowski	825-2489	Mrs. Lauria
1	8	Margie Croak	VA 5-9352	Mrs. Riccobono
1	8	Marie Pascuzzi	VA 5-8401	Mrs. Riccobono
*2nd Grade Representative Jean Savarese, CU 5-5116				
2	5	Julie Sagginario	285-8670	Mrs. Galati
2	5	Di Gregorio	LO 1-8402	Mrs. Galati
2	6	Marie Cusumano	VA 5-4956	Mrs. Guberman
2	6	Marie Spitzfadden	285-6161	Mrs. Guberman
*3rd Grade Representative JoAnn La Barbera, 285-9820				
3	2	Mrs. Boyle	825-7509	Miss Schindelman
3	2	Mrs. Vasil	872-9194	Miss Schindelman
3	1	Pat Collins	CU 5-8839	Miss Firpo
3	1	Mrs. Schneider	872-8409	Miss Firpo
3	A	Mrs. Bocchichio	285-4868	Miss Patterson
3	A	Mrs. Rusinjak	285-8094	Miss Patterson
*4th Grade Representative Mary Ammann, CU 5-6090				
4	3	Mrs. Boody	561-0029	Miss Tracy
4	3	Dorothy Walz	825-8011	Miss Tracy
4	23	Terry Annarumma	285-4925	Mrs. Galbraith
4	23	Ann Prisco	285-5477	Mrs. Galbraith
4	4	Fay Birbiglia	285-9439	Miss Yelland
4	4	Kay Schmidt	872-8692	Miss Yelland
*5th Grade Representative Marie Pascuzzi, 825-8401				
5	28	Jeanette Emler	VA 5-6368	Mrs. Gerdyk
5	28	Jo Ann La Barbera	285-9820	Mrs. Gerdyk
5	28	Jean Savarese	285-5116	Mrs. Gerdyk
5	25	Marie Li Rosi	285-8020	Mr. Camilleri
5	25	Muriel Watterson	825-5478	Mr. Camilleri
5	25	Grace Landon	825-3491	Mr. Camilleri
5	27	Rosalie Guillo	LO 1-1925	Mrs. Breeding
5	27	Hilda Flynn	VA 5-6081	Mrs. Breeding
5	27	Kay Schmidt	872-8692	Mrs. Breeding
*6th Grade Representative Ann Prisco, 285-5744				
6	21	Elena Cirenza	285-5671	Mr. Cooper
6	21	Ronnie Salvaggio	825-5296	Mr. Cooper
6	21	Mary Tragner	285-9502	Mr. Cooper
6	24	Gloria Corradi	285-5255	Mrs. Inwald
6	24	Joy Roccanova	285-8860	Mrs. Inwald
6	24	Jennie Tretola	872-9527	Mrs. Inwald
6	22	Mary Planco	561-6514	Miss Melzer
6	22	Angie Purpura	561-9461	Miss Melzer
6	22	Irene Wood	872-8627	Miss Melzer

*Grade Coordinator

FOREST ROAD SCHOOL

CLASS MOTHER LIST

Class Mother Chairmen
Marlyn Fogel, PY 1-4701 and Diane Kahn PY 1-4756

Grade	Room	Class Mother	Tel. Number	Teacher
*K	AM 201	Phyllis Finkle	791-2568	Mrs. Murray
K	AM 201	Felicia Katz	791-9501	Mrs. Murray
K	PM 201	Linda Jones	791-5816	Mrs. Murray
K	PM 201	Barbara Smerling	791-3540	Mrs. Murray
K	PM 201	Barbara Sultan	791-3021	Mrs. Murray
1	203	Evelyn Grabois	791-1604	Miss Cafiso
*1	203	Judy Orloff	791-3820	Miss Cafiso
1	204	Betty Sabbatini	791-8165	Mrs. Marks
1	204	Linda Zahn	791-4516	Mrs. Marks
2	205	Lydia Rosen	791-5488	Miss Perrich
*2	205	Edith McGee	LO 1-7064	Miss Perrich
2	206	Terry Schultz	561-2989	Miss Post
2	206	Catherine Pappas	791-2608	Miss Post
2	206	Carol Morgenthal	561-1829	Miss Post
3	207	Bea Spector	791-5216	Mrs. Cummings
*3	207	Nancy Cesta	791-8028	Mrs. Cummings
3	209	Trena Danells	791-1506	Miss Clarke
3	209	Shelly Koval	791-1232	Miss Clarke
3	209	Eileen Silverman	791-3257	Miss Clarke
4	210	Marcia Horowitz	791-3529	Miss Bendin
*4	210	Doris Bernanke	791-3790	Miss Bendin
4	211	Madeline Margolies	791-5097	Miss Nancken
4	211	Cecilia Niederman	791-2131	Miss Nancken
5	214	Shirley Hopchick	791-2092	Mrs. Bratt
5	214	Linda Weiss	872-8199	Mrs. Bratt
5	216	Sylvia Haskel	791-7905	Mrs. Neuman
5	216	Joyce Sprung	791-9122	Mrs. Neuman
5	218	Marilyn Sparber	791-6838	Mrs. Caravaggio
*5	218	Barbara Rovin	791-1360	Mrs. Caravaggio
6	215	Beverly Berman	791-4974	Mrs. Kessler
6	215	Irene Bochner	791-6351	Mrs. Kessler
6	217	Fran Eisenstadt	791-4840	Mrs. Melnick
6	217	Toby Kaller	791-2104	Mrs. Melnick
6	220	Fran Krampel	791-5429	Mr. Kaufmann
*6	220	Corky Shaw	791-8807	Mr. Kaufmann

*Grade Coordinator

AUGUST 1972

SUNDAY	MONDAY	TUESDAY	WEDNESDAY	THURSDAY	FRIDAY	SATURDAY
Always spot a well-informed views coincide with yours. know too well their own to assume infallibility; and knows most, knows how little — Thomas Jefferson		1	2	3	4	5
6	7	8 C.H.S. Bd. of Ed. Mtg. 8:00 p.m.	9	10	11	12
13	14	15	16	17	18	19
20	21	22 Dist. No. 30 Bd. of Ed. Mtg. 8:15 p.m.	23	24	25	26
27	28	29	30	31	QUALITY is never an accident; it is the result of skillful work. MODESTY: The art of encouraging people to find out for themselves	

**UNION FREE SCHOOL DISTRICT No. 30 AND
CENTRAL HIGH SCHOOL DISTRICT No. 1,
VALLEY STREAM, NEW YORK**

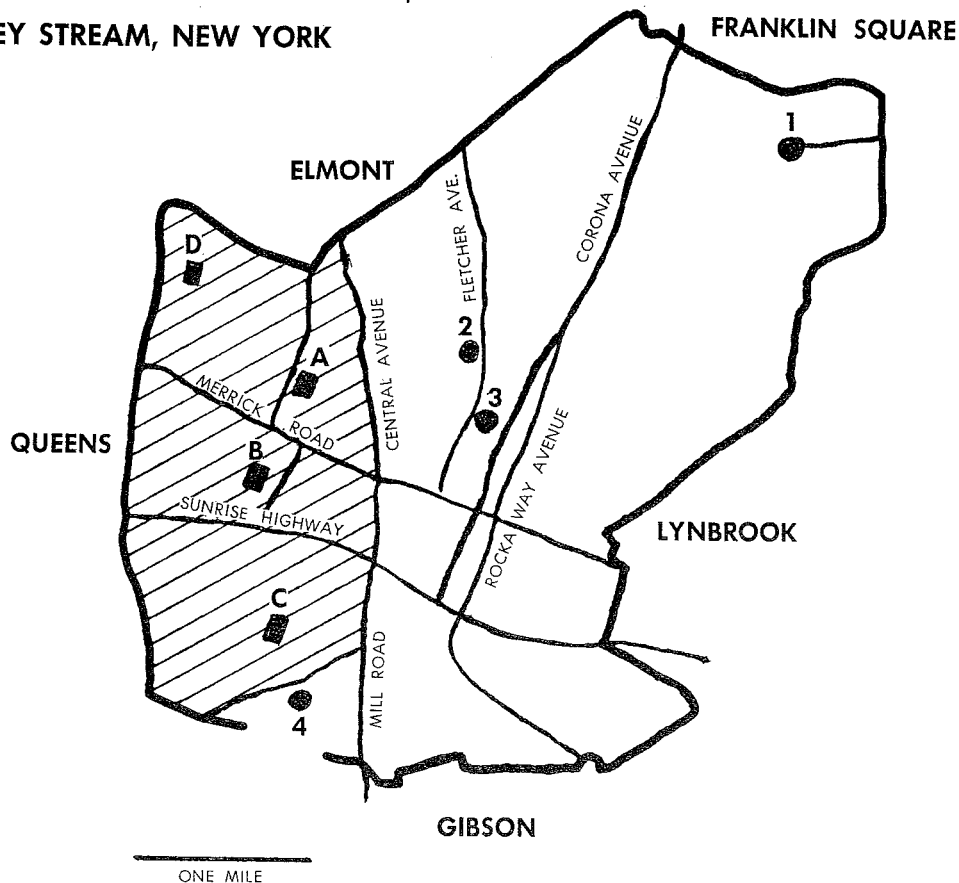

DISTRICT No. 30 SCHOOLS

Shaw Avenue	A
Clear Stream Avenue	B
Forest Road	C
Washington Avenue	D

Shaded Area — District 30

HIGH SCHOOLS

North High	1
Memorial Junior	2
Central High	3
South High	4

SCHOOL TELEPHONE DIRECTORY

SHAW AVENUE SCHOOL		Shaw Avenue School	
Principal	VA 5-9131	Principal's Office	VA 5-9131
Business Office	VA 5-9131	Nurse's Office	VA 5-9131
Media Manager	VA 5-9131		
		Washington Avenue School	
Clear Stream Avenue School		Office	VA 5-9131
Principal's Office	VA 5-3044		
Business Office	VA 5-3044	Special Services	
		Administrative Assistant/Curriculum	VA 5-9131
Forest Road School		Psychologist	VA 5-9131
Principal's Office	PY 1-7676	Speech Consultant	VA 5-9131
Business Office	PY 1-7676	Reading Consultant	PY 1-7676
		Audio-Visual Consultant	LO 1-1165

INDEX

Board of Education and School Calendar	see October
Administration and Special Services	see November
Clear Stream PTA	see December
Shaw and Washington Avenue PTA	see January
Forest Road PTA	see February
Who Wants To Serve On The Board of Education	see March
Time Does Not Stand Still	see April
School Policies	see May and June
Shaw and Washington Class Mothers	see July
Clear Stream and Forest Class Mothers	see August
Map of the District	see facing page

CENTRAL HIGH SCHOOL DISTRICT NO. 1
Telephone Number: VA 5-8642
Use this number for all high school buildings, offices and personnel

NOTES

UNION FREE SCHOOL DISTRICT THIRTY
VALLEY STREAM, NEW YORK

30

SCHOOL ACTIVITIES

Calendar

FOR 1971-1972

UNION FREE SCHOOL DISTRICT THIRTY
VALLEY STREAM, NEW YORK

30

SCHOOL ACTIVITIES

Calendar

FOR 1972-1973

PUBLISHED BY THE BOARD OF EDUCATION AND PARENT-TEACHER ASSOCIATIONS

TELEPHONE DIRECTORY

INDEX

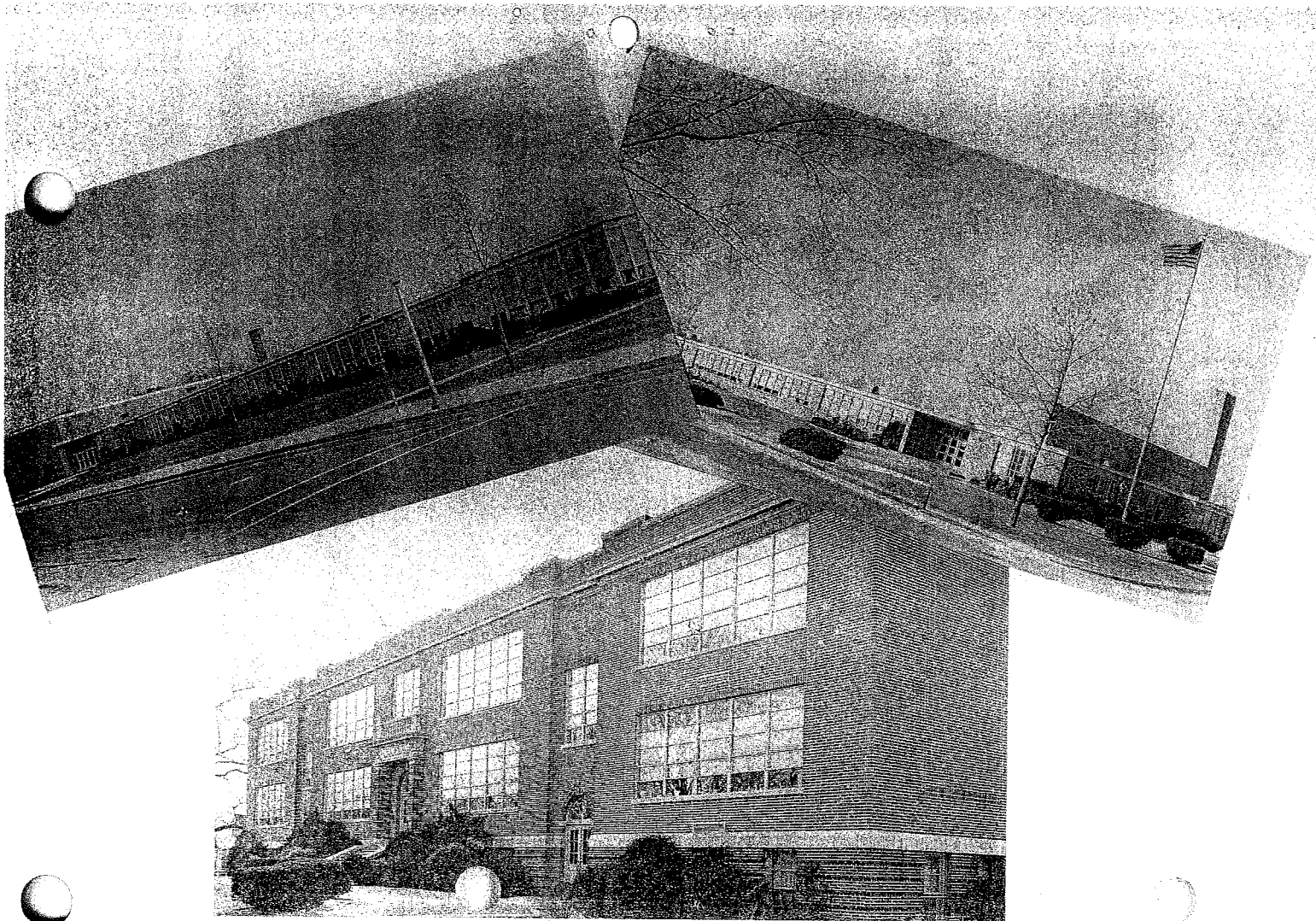

SEPTEMBER 1972

SUNDAY	MONDAY	TUESDAY	WEDNESDAY	THURSDAY	FRIDAY	SATURDAY	
<p>considerable number of people are living on the reputation of their reputation. Don't brag. It isn't the whistle that pulls the train. Pride is at the bottom of all mistakes. — Bernard Ruskin He that would live in peace and ease must not speak all he knows nor judge all he sees. — Benjamin Franklin</p>						1	2
3	4 LABOR DAY	5 Faculty Meeting	6 SCHOOL OPENS PTA Book Cover Sale Clear Stream, 2:45 p.m.	7 PTA Ex. Bd. Mtg. Clear Stream, 9:30 a.m. & Book Cover Sale, 2:45 p.m.	8	9 ROSH HASHANAH	
10 ASHANAH	11	12 C.H.S. Bd. of Ed. Mtg., 8 p.m. Parents' Night, Wash. Ave., 8:15 p.m. Bowling Starts, Forest, 12:30 p.m.	13 PTA Ex. Bd. Mtg., Shaw, 1:00 p.m. Class Mother Mtg., Forest, 8:30 p.m.	14 Parents' Night, Shaw (4-6), 8:15 p.m. Yoga Starts, Forest, 8:30 p.m.	15	16	
17 YOM KIPPUR SCHOOL CLOSED	18	19	20 "Meet the Teacher Nite," Forest, 8:30 P.M.	21 Parents' Night, Shaw (K-3), 8:15 p.m. PTA Gen. Mtg., Clear Stream, 8:00 p.m.	22	23 SUKKOT	
24 Bowling Starts, 5th & 6th Gd., Forest, 3:45 p.m.	25	26 Dist. No. 30 Bd. of Ed. Mtg., 8:15 p.m.	27 Parents' Night, Clear Stream (K-3), 7:30 p.m.	28	29 Parents' Night, Clear Stream (4-6), 7:30 p.m.	30 Shemini Atzeret	

BOARD OF EDUCATION

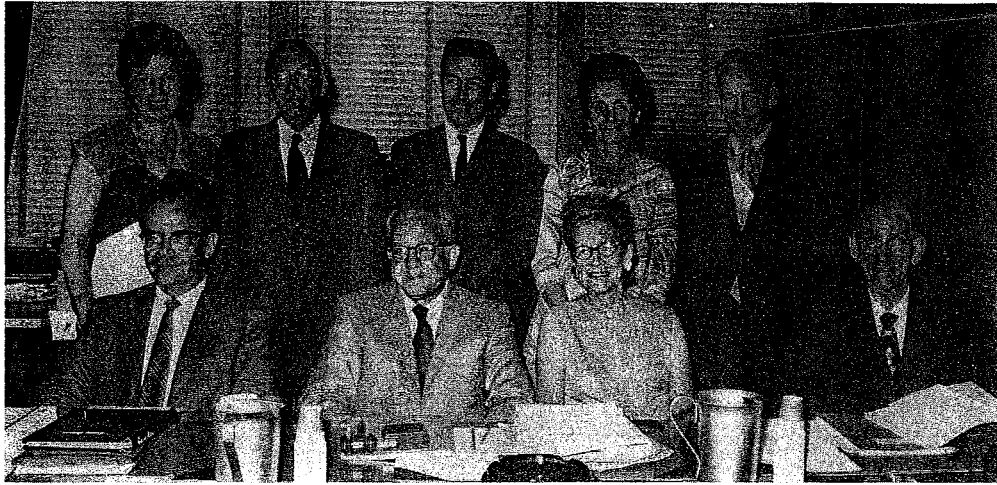

Standing (left to right): Eleanor Zeller, Board Clerk; George Adams, School Attorney; Joseph Barry; Eleanor Berger, Board Treasurer; Sherwood Quick, District Principal. Seated: James R. Smith*, Vice-president; Nathaniel Altschul*, Elinor McAuliffe*, President; Robert Bell.
 *Also serves on High School Board.

SCHOOL CALENDAR, 1972-1973

Meetings	Tues., Sept. 5	Winter Recess (Includes Lincoln's Birthday)
Open for Students	Wed., Sept. 6	School closes at regular time
Rosh Hashanah	Sat. & Sun., Sept. 9, 10 Fri., Feb. 9
Tippur	Mon., Sept. 18	Schools Reopen
Yom Kippur Day	Mon., Oct. 9 Mon., Feb. 19
Simchat Torah	Mon., Oct. 23	Easter Recess (Includes all Passover Days)
Shmini Atzeret Day	Tues., Nov. 7	Schools close at regular time
Winter Recess	Schools close at end of morning session Fri., April 13
	Wed., Nov. 22	School Reopens
	Schools Reopen Wed., April 25
	Mon., Nov. 27	Memorial Day
	School closes at regular time n., May 1
	Wed., Dec. 22	Last Day of School
	School Reopens Fri., June 22
	Tues., Jan. 2	

OCTOBER 1972

SUNDAY	MONDAY	TUESDAY	WEDNESDAY	THURSDAY	FRIDAY	SATURDAY
1 Yom Kippur	2 PTA Council Mtg., Howell Road, 8 p.m.	3	4 PTA Ex. Bd. Mtgs., Shaw, 1:00 p.m. & Clear Stream, 9:30 a.m. & Forest, 8:30 p.m.	5	6 Cultural Arts Assembly, Shaw	7
8	9 COLUMBUS DAY SCHOOL CLOSED PTA Movie, 1 p.m. Clear Stream	10 C.H.S. Bd. of Ed. Mtg., 8:00 p.m.	11 Prizo-Nite, Forest, 8:30 p.m.	12	13	14
15	16	17 PTA Jelly Apple Sale, 2:45 p.m., Clear Stream	18 PTA Jelly Apple Sale, 2:45 p.m., Clear Stream "Know Your Curriculum," Forest, 8:30 p.m.	19	20	21
22	23 VETERAN'S DAY SCHOOL CLOSED PTA Movie, 1 p.m. Clear Stream	24 Dist. No. 30 Bd. of Ed. Mtg., 8:15 p.m.	25 Home Tour, Forest, 12:30 p.m.	26 PTA Gen. Mtg., Shaw, 8:15 p.m.	27 6th Grade Hallowe'en Party, Forest	28
29	30	31 HALLOWE'EN Hallowe'en parties, Shaw & Washington,	Heaven is indeed kind when it gives us good parents. — Marmontel If you tell the truth you don't have to remember anything. — Mark Twain			

SCHOOL ADMINISTRATION

Dr. William T. Callahan, *District Superintendent*

Sherwood S. Quick
District Principal

SCHOOL PRINCIPALS

CLEAR STREAM AVENUE SCHOOL
Richard M. Burbell

FOREST ROAD SCHOOL
Maurice E. St. Mary

SHAW AVENUE SCHOOL
Lawrence Cid

William J. Van Ness, *Administrative Assistant/Curriculum*
George W. Niederhauser, *Administrative Assistant/Business*

SCHOOL SECRETARIES

Jeanne Feeney, *Clear Stream Avenue*
Mary McDowell, *Forest Road*
Jean Annona, *Shaw Avenue*

DISTRICT SECRETARIAL STAFF

Garet Bradley, Lucy Felice, Helen Kuchler
Marie O'Connell, Gloria Zweier, Mary Ribando
Edythe Sanchez, Caroline Young

Evelyn Pearn, *Cafeteria Manager*

DISTRICT SPECIALISTS AND SPECIAL TEACHERS

Frank DeMarco, *Director of Educational Communications*
Rosalyn Kessler, *Psychologist*
Estelle Friedman, *Psychologist*
Raydine Teicheira, *Speech Consultant*
Frances Pollet, *Speech Teacher*
Susan Wasserman, *Foreign Language Consultant*
Henry Kohlmann, *Instrumental Music Teacher*
Barbara Epstein, *Instrumental Music Teacher*

OTHER SPECIALISTS AND SPECIAL TEACHERS

Clear Stream Avenue School

Cathleen Meneilly, *Special Counselor*
Janet Poppe, *Reading Specialist*
Grace Giacobone, *Art*
Philip Hessemer, *Physical Education*
Joan Henningsen, *Physical Education*
Linda Pratt, *Music*
Ruth Newman, *Library Media Specialist*
Edna Giebel, *Nurse-Teacher*

Forest Road School

Helen Fink, *Special Counselor*
Ada Keaney, *Reading Consultant*
Eileen Goldsmith, *Art*
Alfred Stevens, *Physical Education*
Joan Henningsen, *Physical Education*
Frances Gibson, *Music*
Rose Agree, *Library Media Specialist*
Hilda Rosenfeld, *Nurse-Teacher*

Shaw Avenue School

Noel Giambalvo, *Special Counselor*
Jeanne Colton, *Reading Specialist*
Rosemary Williams, *Reading Teacher*
Linda Sleiartin, *Art*
Anita Lafayette, *Art*
Thomas Rouse, *Physical Education*
Linda DeMadona, *Physical Education*
Kathryn Egan, *Music*
Barbara Briker, *Music*
Sylvia Berkowitz, *Library Media Specialist*
Dorothy McCutchan, *Nurse-Teacher*

NOVEMBER 1972

MONDAY	TUESDAY	WEDNESDAY	THURSDAY	FRIDAY	SATURDAY
1 at the birds: the dove brings peace and the stork s exemptions. ning of the heart ages more people than hardening arteries. ll town is usually a place that is divided by a railway, 1 street, two churches and a lot of opinions.	2	3 PTA Ex. Bd. Mtg., Shaw, 1:00 p.m. Hallowe'en Candy Collection for the needy, 8:30 p.m. Forest	4 PTA Ex. Bd. Mtg., Clear Stream, 9:30 a.m.	5	6
7 SCHOOL WEEK	8 ELECTION DAY SCHOOL CLOSED Voting 6 a.m. to 9 p.m. C.H.S. Bd. of Ed. Mtg., 8:00 p.m.	9	10 Cook Book Sale, Forest	11 PTA Auction Sale, Clear Stream, 8:15 p.m.	12 PTA Movie, Shaw
13	14	15 Teacher's Recognition Day Luncheon, Shaw Pre-School Mtg., Forest, 3:00 p.m. and Women's Workshop, Forest, 8:30 p.m.	16 PTA Gen. Mtg., Clear Stream, 8:00 p.m.	17	18
19	20	21 Pre-School Mtg., Shaw & Washington, 3:00 to 3:30 p.m.	22 SCHOOL CLOSING AT 12:00 NOON Report Cards sent home	23 THANKSGIVING DAY SCHOOL CLOSED	24 SCHOOL CLOSED
25	26	27 Boutique Opens, Forest	28 PTA Mental Health Mtg., Mary Greene, Forest, 8:30 p.m.	29	30

CLEAR STREAM AVENUE PARENT TEACHER ASSOCIATION

ELECTED OFFICERS 1972-1973

Co-President	Margaret Carlson	285-8857
Co-President	Marilyn Margolies	285-9465
First Vice President	Marie Pascuzzi	825-8401
Second Vice President	Rose McMeekin	285-4925
Third Vice President	Stephanie Klein	825-0151
Fourth Honorary Vice President	Edith Yelland	Faculty
Fourth Vice President	Joan King	285-9718
Treasurer	Mary Ammann	285-6090
Membership	Beverly Jablonowski	825-2489
	Jo Ann La Barbera	285-9820
Recording Secretary	Irene Wood	872-8627
Corresponding Secretary	Jennie Tretola	872-9527
Delegates to Council	Mrs. Guberman	Faculty
	Marie Li Rosi	285-8020
	Rose La Russo	872-8079
	Jeanette Ermiler	825-6368

Past President
Mrs. Viniak

COMMITTEE CHAIRMEN

Arts and Flyers	Gloria Corradi	285-5255
Typing	Marge Croak	825-9352
Audio-Visual	Frank DeMarco	Faculty
Budget	Jean Savarese	285-5116
Cultural Arts	Mrs. Linda Pratt	Faculty
	Lee Egan	825-8975
Health	Mrs. Edna Giebel	Faculty
Safety	Elena Cirenza	285-5671
Historian	Marilyn Palazzo	872-3372
Legislation	Terry Keller	285-7016
Mimeographers	Lois Barry	285-8654
	Terry Annaruma	285-9336
	Nettie Ghiardella	561-6450
School & Community	Rose McMeekin	285-9820
Pre-School	Pat Collins	285-8839
	Rose McMeekin	285-4925
Sunshine	Stephanie Klein	825-0151
THE STREAMER	Ann Prisco	285-5744
Editor	Muriel Watterson	825-5478
Distribution	Terry Annaruma	285-9336
Ways & Means	Kay Ciccione	LO 1-9207
Auction	Connie Deering	285-6210
	Dorothy Walz	825-8011
Cake Sale	Pat Collins	285-8839
Jelly Apple Sale	Evelyn McGowan	285-6222
Bowling	Marie Grande	LO 1-6310
Movies	Mary Tragnor	285-9502
	Ann Prisco	285-5744
	Jennie Tretola	872-9527
	Gloria Corradi	285-5255
	Ann Finazzo	285-6660
	Rose La Russo	872-8079
	Stephanie Klein	825-0151
	Marie Li Rosi	285-8020

67-9-7234

Publicity	Hilda Flynn	825-6081
Publications	Dorothy Walz	825-8011
Grade Rep. Chairman	Jeanette Ermiler	825-6368
Kindergarten Rep.	Eileen Callendreno	872-6778
1st Grade Rep.	Rose McMeekin	285-9820
2nd Grade Rep.	Beverly Jablonowski	825-2489
3rd Grade Rep.	Jean Savarese	285-5116
4th Grade Rep.	Jo Ann La Barbera	285-9820
5th Grade Rep.	Mary Ammann	285-6090
6th Grade Rep.	Mary Pascuzzi	825-8401

P.T.A. PROGRAM

Special Note: There will be a bowling league from Clear Stream that will meet on Tuesdays at the Green Acres Bowling Alley beginning September 12th at 10 a.m. Car pools are arranged for kindergarten mothers.

Sept.	6	Book Cover Sale, 2:45 p.m.
	7	Book Cover Sale, 2:45 p.m.; Executive Board Meeting, 9:30 a.m.
	21	General Meeting, 8:00 p.m.
	27	Parents' Night (K-3), 7:30 p.m.
	29	Parents' Night (4-6), 7:30 p.m.
Oct.	5	Executive Board Meeting, 9:30 a.m.
	9	Children's Movies, 1:00 p.m.
	17	Jelly Apple Sale, 2:45 p.m.
	18	Jelly Apple Sale, 2:45 p.m.
	23	Children's Movies, 1:00 p.m.
	31	Hallowe'en Party for 5th & 6th grades
Nov.	2	Executive Board Meeting, 9:30 a.m.
	10	Auction Sale, 8:15 p.m.
	17	General Meeting, 8:00 p.m.
Dec.	7	Executive Board Meeting, 9:30 a.m.
	14	Holiday Assembly
Jan.	4	Executive Board Meeting, 9:30 a.m.
	18	General Meeting, 8:00 p.m.
Feb.	1	Executive Board Meeting, 9:30 a.m.
	7	Cake Sale, 2:45 p.m.
Mar.	1	Executive Board Meeting, 9:30 a.m.
	9	Father, Son, Daughter Nite, 7:30 p.m.
	15	General Meeting and Workshop, 1:30 p.m.
	26	Sex Hygiene Meeting (6th grade boys and girls), 7:30 p.m.
Apr.	5	Executive Board Meeting, 9:30 a.m.
	13	Family Nite at the Movies, 7:30 p.m.
May	2	Executive Board Meeting, 9:30 a.m.
	5	Vision Screening
	9	Teachers' Recognition Day
	12	Vision Screening
	17	General Meeting, Installation of Officers, 8:00 p.m.
	24	Cake Sale
June	7	Executive Board Meeting (Joint), 8:00 p.m.

D E C E M B E R 1 9 7 2

SUNDAY	MONDAY	TUESDAY	WEDNESDAY	THURSDAY	FRIDAY	SATURDAY
					1	2
<p>Who that falls in love with himself will have no rivals.</p> <p>Being right occasionally is not enough. A stopped clock is right twice a day.</p> <p>YOUTH is the time to study wisdom: OLD AGE is the time to practice it.</p> <p>Visits always give pleasure—if not the coming, then the going.</p>						CHANUKAH
3	4	5	6	7	8	9
	PTA Council Mtg., Forest, 8:00 p.m.		PTA Ex. Bd. Migs., Shaw, 1:00 p.m. & Forest, 8:30 p.m.	PTA Ex. Bd. Mtg., Clear Stream, 9:30 a.m.	Last day of Chanukah Family Square Dance, Forest, 8:00 p.m.	
10	11	12	13	14	15	16
		C.H.S. Bd. of Ed. Mtg., 8:00 p.m.		PTA Holiday Assembly, Clear Stream	PTA Holiday Assemblies, Shaw & Forest	
17	18	19	20	21	22	23
		Dist. No. 30 Bd. of Ed. Mtg., 8:15 p.m.			SCHOOL CLOSURES FOR CHRISTMAS VACATION	
24	25	26	27	28	29	30
AS EVE	CHRISTMAS DAY SCHOOL CLOSED		SCHOOL CLOSED	SCHOOL CLOSED	SCHOOL CLOSED	SCHOOL CLOSED

SHAW AND WASHINGTON AVENUES PARENT TEACHER ASSOCIATION

ELECTED OFFICERS 1972-1973

President	Jean Layden	285-7624
First Vice President	Diane Keenan	CU 5-6068
Second Vice President	Anita Filosa	LO 1-0074
Treasurer	Grace Pisano	872-3097
Recording Secretary	Mary Zeiner	285-9898
Financial Secretary	Louise Kiel	CU 5-9651
Communications Secretary	Marie Casale	825-7872
Delegates to Council	Lillian Ging	CU 5-6072
	Carl Riccobono	Faculty
Past President	Lillian Fayet	561-6973

Kindergarten Rep.	Susan Jacobs	872-3144
1st Grade Rep.	Ginny Kropas	872-8117
2nd Grade Rep.	Lonnie DiLuccio	LO 1-6837
3rd Grade Rep.	Anita Filosa	LO 1-0074
4th Grade Rep.	Ruth Cohen	VA 5-4381
5th Grade Rep.	Lee Short	825-5019
6th Grade Rep.	Maureen Pascale	825-0303

COMMITTEE CHAIRMEN

Audio-Visual	John Giacalone	Faculty
Budget	Stella Schlaeger	CU 5-7588
Member	Lillian Fayet	561-6973
Cultural Arts	Grace Duffy	LO 1-9291
Distribution	Kay Hadjiyane	CU 5-7434
Grade Rep. Coordinator	Eileen Coughlin	825-2264
Halloween Party	Marie DiGiarno	LO 1-0079
Historian	Virginia Tizio	825-2598
Health and Safety	Lois Patronzino	285-5102
Hospitality	Grace Pisano	872-3097
Legislation	Jean Yocono	VA 5-0728
Membership	Lillian Fayet	561-6973
Mental Health	Stella Schlaeger	CU 5-7588
Timeograph	Marie Casale	825-7872
Newsletter	Gloria Zweier	825-9001
Parent Education	Diane Keenan	CU 5-6068
Parliamentarian	Lillian Ging	CU 5-6072
Pre-School	Lillian Fayet	561-6973
	Cathy Dwyer	CU 5-5283
	Rita Dolan	CU 5-6008
Program	Judith Blessinger	Faculty
Publicity	Anita Filosa	LO 1-0074
School Board Rep.	Susan Jacobs	872-3144
Vision Screening	Lillian Fayet	561-6973
	Louise Kiel	CU 5-9651
	Grace Pisano	872-3097
Days and Means		
Bowling League, Pres.	Mary Zeiner	285-9898
Treas.	Barbara Knechtal	285-5786
Asst. Treas.	Sally Greenwald	285-6781
Cup Cake Sale	Anita Filosa	LO 1-0074
Fashion Show—Chairlady	Marie Casale	825-7872
Pretzel Sale	Terry Buonfiglio	872-9577
Movies	Diane Keenan	CU 5-6068
	Lonnie DiLuccio	LO 1-6837

P.T.A. PROGRAM

Sept.	12	Parent's Night—Washington Ave.—8:15 p.m.
	13	Executive Board Meeting—1:00 p.m.
	14	Parent's Night—Shaw Ave.—4 to 6—8:15 p.m.
	21	Parent's Night—Shaw Ave.—K to 3—8:15 p.m.
Oct.	4	Executive Board Meeting—1:00 p.m.
	6	Cultural Arts Assembly
	26	General Meeting (Parent Ed.)—8:15 p.m.
	31	Halloween Parties for Children, Shaw and Washington Ave. Schools—3:00 to 4:30 p.m.
Nov.	1	Executive Board Meeting—1:00 p.m.
	11	PTA Movie—Shaw
	15	Teacher's Recognition Day Luncheon
	21	Pre-School—Shaw and Washington Ave.—3:00 to 3:30 p.m.
Dec.	6	Executive Board Meeting—1:00 p.m.
	15	PTA Holiday Assembly—Shaw
Jan.	3	Executive Board Meeting—1:00 p.m.
	9	Cupcake Sale—Shaw and Washington Ave. Schools
	17	General Meeting (Mental Health)—8:15 p.m.
	23	Pre-School—Shaw and Washington Ave.—3:00 to 3:30 p.m.
Feb.	7	Executive Board Meeting—8:15 p.m.
	21	Founders Day (Shaw Avenue School)
Mar.	7	Executive Board Meeting—1:00 p.m.
	13	Pre-School—Shaw and Washington Ave.—3:00 to 3:30 p.m.
	20	Fashion Show—p.m.
April	4	General Meeting (Parent Ed.)—Afternoon
	13	Cultural Arts Assembly
	26	Sex Hygiene Mtg., Fathers & 6th Grade Boys—8:00 p.m.
	28	Vision Screening—a.m.
May	3	Executive Board Meeting—1:00 p.m.
	7	Sex Hygiene Mtg.—5th & 6th Grade Mothers—1:00 p.m.
	9	Sex Hygiene Mtg.—5th Grade Girls—3:00 p.m.
	11	Sex Hygiene Mtg.—6th Grade Girls—3:00 p.m.
	17	Pretzel Sale—Shaw and Washington Ave. Schools
	23	Installation Night—8:00 p.m.
June	6	Joint Executive Board Meeting—1:00 p.m.

JANUARY 1973

SUNDAY	MONDAY	TUESDAY	WEDNESDAY	THURSDAY	FRIDAY	SATURDAY
	1 NEW YEAR'S DAY SCHOOL CLOSED	2 SCHOOL REOPENS	3 PTA Ex. Bd. Mtgs., Shaw, 1:00 p.m. & Forest, 8:30 p.m.	4 PTA Ex. Bd. Mtg., Clear Stream, 9:30 a.m.	5	6
7	8	9 C.H.S. Bd. of Ed. Mtg., 8:00 p.m. PTA Cupcake Sale, Shaw & Washington	10 Women's Workshop No. 2, Forest Road	11	12	13
14	15	16	17 PTA Gen Mtg., Shaw, 8:15 p.m. Pre-School Mtg., Forest, 2:00 p.m.	18 PTA Gen Mtg., Clear Stream, 8:00 p.m.	19	20
21 PTA Clothing Drive Starts, Forest	22	23 Dist. No. 30 Bd. of Ed. Mtg., 8:15 p.m. Pre-School Mtg., Shaw & Washington, 3:00-3:30 p.m.	24	25	26	27
28	29	30	31	The reasonable man adapts himself to the world; the unreasonable one persists in trying to adapt the world to himself. * * * * Therefore all progress depends upon the unreasonable man. —George Bernard Shaw		

FOREST ROAD PARENT TEACHER ASSOCIATION

ELECTED OFFICERS 1972-1973

President	Renee Pepper	791-3857
First Vice President	Ginny Levine	872-9165
Second Vice President	Judy Orloff	791-3820
Third Vice President	Nancy Cesta	PY 1-8028
Fourth Vice President	Anita Strelisker	PY 1-7167
Treasurer	Doris Bernanke	791-3790
Financial Secretary	Barbara Rovin	791-1360
Recording Secretary	Evelyn Grabois	PY 1-1604
Corresponding Secretary	Linda Zahn	791-4516
Delegate to Council	Eleanor Klein	791-3060

COMMITTEE CHAIRMEN

Amblyopia	Ruth Bazil	791-8556
Art on Tour	Abbey Tedesco	791-2157
Budget	Marie Briody	PY 1-5817
Class Mothers	Elaine Sandler	PY 1-5765
Cultural Arts	Rochelle Ladetsky	791-3995
Children's Theatre	Paulette Kirschenbaum	PY 1-7045
Ecology	Trena Daniels	PY 1-1506
Family Living	Ruth Bazil	PY 1-8556
Flyers	Marie Briody	PY 1-5817
Goodwill	Anita Strelisker	791-1360
Hospitality	Evelyn Grabois	791-7746
Health & Safety	Florence Goldberg	791-1604
Historian	Evelyn Grabois	825-5915
Legislation	Carol Provenzano	791-5097
Membership	Madeline Margolies	PY 1-2960
Mimeograph	Anita Suriani	PY 1-3980
Newsletter	Marion Lowenbraun	PY 1-6475
Parliamentarian	Rhoda Blaustein	PY 1-3627
Posters	Marcia Balaban	PY 1-5794
Pre-School	Audrey Rumph	PY 1-8807
Program Chairman	Corky Shaw	791-1360
Publicity	Barbara Rovin	LO* 1-7064
School Bd. Rep. - Elem.	Edith Magee	791-5216
Summer Recreation	Bea Spector	PY 1-4008
Teachers Rep.	Ann Berger	791-3857
Typist	Donald Pepper	PY 1-4734
Ways & Means	Jack Neiderman	872-9165
Bowling	Ginny Levine	PY 1-3820
Bowling (5th/6th Grades)	Judy Orloff	PY 1-3592
Home Tour	Marcia Horowitz	PY 1-8028
Recipe Books	Nancy Cesta	PY 1-2568
Square Dance	Phyllis Finkle	Faculty
	Blossom Melnick	561-2939
	Terry Schultz	
	Felicia Katz	PY 1-9501
	Doris Bernanke	PY 1-3790
	Doris Bernanke	PY 1-3790
	Cecilia Neiderman	PY 1-4734
	Marcia Horowitz	791-3529
	Corky Shaw	PY 1-8807
	Pearl Lustbader	PY 1-9854
	Toby Kaller	PY 1-2104
	Irene Bochner	PY 1-6351

Prizo-Nite Holiday Boutique

Kindergarten Rep. 1st Grade Rep. 2nd Grade Rep. 3rd Grade Rep. 4th Grade Rep. 5th Grade Rep. 6th Grade Rep.

Phyllis Wollin
Diane Kahn
Estelle Glazer
Marlyn Fogel

Betty Sabbatini
Estelle Glazer
Evelyn Grabois
Edith Magee
Corky Shaw
Doris Bernanke
Pearl Lustbader

PY 1-8120
PY 1-4756
PY 1-5308
PY 1-4701

PY 1-8165
PY 1-5308
PY 1-1604
LO 1-7064
PY 1-8807
PY 1-3790
PY 1-9854

P.T.A. PROGRAM

Sept.	12	Bowling Starts, 12:30 p.m.
	13	Class Mother Meeting, 8:30 p.m.
	14	Yoga Starts, 8:30 p.m.
	20	Meet the Teacher Night, 8:30 p.m.
	25	5th & 6th Grade Bowling Starts, 3:45 p.m.
Oct.	4	Executive Board Meeting, 8:30 p.m.
	11	Prizo-Nite, 8:30 p.m.
	18	"Know Your Curriculum," Mr. Van Ness, 8:30 p.m.
	25	Home Tour, 12:30 p.m.
	27	6th Grade Hallowe'en Party
Nov.	1	Hallowe'en Collection of Candy for Needy; Executive Board Meeting, 8:30 p.m.
	9	Cook Books on Sale
	15	Pre-School Meeting, 3:00 p.m.; Woman's Workshop, 8:30 p.m.
	27	Boutique Opens
	29	Mental Health Meeting, Mary Greene, 8:30 p.m.
Dec.	6	Pre-School Meeting, 2:00 p.m.; Executive Board Meeting, 8:30 p.m.
	8	Family Square Dance, 8:00 p.m.
	15	Holiday Program for Children
Jan.	3	Executive Board Meeting, 8:30 p.m.
	10	Woman's Workshop No. 2
	17	Pre-School Meeting, 2:00 p.m.
	22	Clothing Drive Starts
Feb.	7	Executive Board Meeting, 8:30 p.m.
	22	Pre-School Meeting, 3:00 p.m.
	28	Music Show
Mar.	7	Executive Board Meeting, 8:30 p.m.
	19	Sex Hygiene Meeting
	20	Sex Hygiene Meeting
	21	Pre-School Meeting, 2:00 p.m.; Science Fair, 7:30 p.m.
	22	Sex Hygiene Meeting
	23	Sex Hygiene Meeting
April	4	Executive Board Meeting, 8:30 p.m.
	11	Gym Show, 7:30 p.m.
	26	Pre-School Meeting, 3:00 p.m.
May	2	Executive Board Meeting, 8:30 p.m.
	23	General Meeting, Installation of Officers, 8:00 p.m.
June	6	Teachers' Recognition Day Luncheon
	13	Joint Executive Board Meeting, 8:30 p.m.

FEBRUARY 1973

SUNDAY	MONDAY	TUESDAY	WEDNESDAY	THURSDAY	FRIDAY	SATURDAY
				1	2	3
ent of flowers does not travel against the wind, nor that of sandalwood or ara and Mallika flowers, but the odor of good people travels against the a good man pervades every place. — Sanskrit				PTA Ex. Bd. Mtg., Clear Stream, 9:30 a.m.		
4	5	6	7	8	9	10
	PTA Ex. Council Mtg., Corona Ave., 8:00 p.m.	C.H.S. Bd. of Ed. Mtg., 8:00 p.m.	Report Cards Sent Home PTA Ex. Bd. Mtgs., Shaw, 8:15 p.m. & Forest, 8:30 p.m. PTA Cake Sale, Clear Stream, 2:45 p.m.			
11	12	13	14	15	16	17
	LINCOLN'S BIRTHDAY SCHOOL CLOSED	SCHOOL CLOSED WINTER RECESS	SCHOOL CLOSED WINTER RECESS	SCHOOL CLOSED WINTER RECESS	SCHOOL CLOSED WINTER RECESS	
18	19	20	21	22	23	24
	WASHINGTON'S BIRTHDAY SCHOOL OPEN		PTA Founder's Day Mtg., Shaw, 8:15 p.m. for all schools	Pre-School Mtg., Forest, 3:00 p.m.		
25	26	27	28	HAPPINESS—is a perfume you cannot pour on others without getting a few drops on yourself. — Ralph Waldo Emerson		
		Dist. No. 30 Bd. of Ed. Mtg., 8:15 p.m.	Music Show, Forest			

THE DEVELOPMENT OF PERCEPTUAL SKILLS

The close relationship between the perceptual development of the young child and the learning process has been well established.

Perception is the ability to understand the world around us. It involves the brain's interpretation of what the eyes see in terms of meaning and action. No one is born with this ability; it is developed. It does not have a direct connection with intelligence. A child develops perceptual skills through the use of all his senses. The greatest period of perceptual growth occurs between the ages of 3½ and 8 years.

Perceptual ability is more than receiving sensory impressions from the world around us through one's body. It is the ability to identify and interpret these sensory impressions and also to integrate them with previous experiences. Therefore, a child perceives and develops an understanding of his world in relation to his own body and his experiences.

The following is a brief outline of the kinds of activities you and your child can do together which will help to develop perceptual skills and abilities within this five year span. It should be remembered however that children develop at different rates and the activities selected should be within the child's capabilities.

I. MOTOR DEVELOPMENT

A. Large muscle coordination:

1. Games involving skipping, jumping, climbing, hopping and throwing
2. Creeping and crawling games (such as following knee and hand prints along a course)

B. Fine motor coordination:

1. Buttoning
2. Lacing
3. Clay work
4. Finger painting
5. Puzzles

C. Visual-Motor activities:

1. Ball throwing and catching
2. Nail pounding
3. Bead stringing
4. Block building

II. BODY IMAGE

The child has to develop an understanding of the left and right side of his own body, as well as an understanding of what is the left or right side of whatever object he is looking at. The child must know that left or right are always in reference to himself.

- A. Identification of body parts (touch your toes, head, neck, etc.)
- B. Figure assembly

III. PERCEPTUAL CONSTANCY

This refers to the ability to recognize an object regardless of its position, color, size and brightness.

- A. Matching and sorting different geometric shapes or objects
- B. Picture selection on the basis of likenesses or differences
- C. Finding different sizes of the same objects

IV. AUDITORY PERCEPTION

This refers to the ability to discriminate between different sounds and associate these sounds with previous experiences.

- A. Listening to records
- B. Listening games in which the child must:
 1. Identify various sounds (humming, clapping, tapping, etc.)
 2. Discriminate between high and low pitch, loud and soft, like and unlike, and near and far sounds

V. TACTILE DISCRIMINATION

A. Seeing, touching and comparing objects of different texture, temperature, and size

B. Identifying different shapes when blindfolded

This *limited* list of suggested activities will aid your child in developing the ability to select and coordinate the information he receives through his senses and provide a base for future learning.

ADA KEANEY
Reading Consultant

MARCH 1973

SUNDAY	MONDAY	TUESDAY	WEDNESDAY	THURSDAY	FRIDAY	SATURDAY
			<p>IDS are to be enjoyed—like flowers, or music, or the stars; — They are not used like napkins, umbrellas, or crutches. — Walter Adams</p> <p>people consider the things government does for them to be social progress, they regard the things government does for others as socialism. — Earl Warren</p>	1 PTA Ex. Bd. Mtg., Clear Stream, 9:30 a.m.	2	3
4	5	6	7 ASH WEDNESDAY PTA Ex. Bd. Mtgs., Shaw, 1:00 p.m. & Forest, 8:30 p.m.	8	9 PTA Father, Son, Daughter Night, Clear Stream, 7:30 p.m.	10
11	12	13 C.H.S. Bd. of Ed. Mtg., 8:00 p.m. Pre-School Mtg., Shaw & Washington, 3:00-3:30 p.m.	14	15 PTA Gen Mtg., & Workshop, Clear Stream, 1:30 p.m.	16	17
18 Sex Hyg. Mtg., Forest	19	20 PTA Fashion Show, Shaw Sex Hyg. Mtg., Forest	21 Pre-School Mtg., Forest, 2:00 p.m. Science Fair, Forest, 7:30 p.m.	22 Sex Hyg. Mtg., Forest	23 District Music Concert, Shaw, 8:15 p.m. Sex Hyg. Mtg., Forest	24
25 Sex Hyg. Mtg., (6th gr. Boys & Girls) Clear Stream, 7:30 p.m.	26	27 Dist. No. 30 Bd. of Ed. Mtg., 8:15 p.m.	28	29	30	31

PARENTS AS MODELS FOR CHILDREN'S SPEECH

When a child enters school he has already acquired a pattern of language and speech. By means of a process of trial and error he has adjusted to his family and friends' language and speech structure. His own system of communication is a result. He can't quite produce all sounds, he can approximate them as to be understood. He is said to have a vocabulary of one thousand words or more for each year of his life. This is a large vocabulary, to be sure, but in our complex society it is not large enough. It is necessary for him to learn additional meanings for the words he knows and to increase his vocabulary. He also has to refine his sound production so that it becomes readily understandable.

As parents and teachers we can provide models for children to grow naturally and build upon what the child already knows. The following is a suggested list of things we as parents and teachers can do to help:

1. Set a good example by using clear, unhurried speech. A child learns by imitation!
2. Don't let other children in the family speak for a child.
3. Teach your children to *listen* (to directions, stories, poems, etc.). Poor listening habits should not be confused with faulty hearing. A child's hearing may be perfect and yet he may not be able to listen well enough to hear the difference between similar consonants (p-b, t-d).
4. Keep your face turned toward your child while conversing. In order to imitate correctly, the child must perceive the correct formation of tongue, lips and teeth.

5. Don't talk baby talk! Encourage independence. A child will cling to immature patterns for security and protection.

6. Don't overcorrect or nag. Merely repeat a sound or word gently and correctly.

7. If your child hesitates or repeats sounds (which is quite normal) do *not* ask him to slow down, take a deep breath, and start over. Do not call attention to his speech pattern.

8. Present a calm unhurried atmosphere in which your child can communicate freely.

9. Remember to name things for children, and to expose them whenever possible to enriching experiences (trips, shopping, museums, etc.) which will increase language skills.

In District No. 30 great emphasis is placed on expanding vocabulary and encouraging good listening and communication in the early grades. The speech teachers conduct weekly lessons in Kindergarten and First grade which are reinforced by daily classroom activities.

Beginning in second grade, those children who need additional help with developing language or specific speech sounds are placed in a corrective program. It is a district policy to begin actual speech therapy in second grade except where a severe communication disorder is evident. Children work in small groups, with the children leaving their classrooms at a time mutually arranged by the classroom and the speech teacher.

RAYDINE TEICHEIRA
Speech Consultant

APRIL 1973

SUNDAY	MONDAY	TUESDAY	WEDNESDAY	THURSDAY	FRIDAY	SATURDAY
1	2 PTA Council Mtg., Wm. L. Buck School, 8:00 p.m.	3	4 PTA Gen. Mtgs., afternoon, Shaw & 8:30 p.m., Forest	5 PTA Ex. Bd. Mtg., Clear Stream, 9:30 a.m.	6	7
8	9	10 C.H.S. Bd. of Ed. Mtg., 8:00 p.m.	11 Gym Show, Forest, 7:30 p.m.	12	13 Cultural Arts Assembly, Shaw PTA Family Nite at the Movies, Clear Stream, 7:30 p.m.	14
15 SUNDAY	16 EASTER RECESS SCHOOL CLOSED	17 FIRST DAY OF PASSOVER SCHOOL CLOSED	18 SECOND DAY OF PASSOVER SCHOOL CLOSED	19 HOLY THURSDAY SCHOOL CLOSED	20 GOOD FRIDAY SCHOOL CLOSED	21 Reg. for school budget vote, 7 a.m. to 12 Noon, Each school
22 SUNDAY	23 SEVENTH DAY OF PASSOVER SCHOOL CLOSED	24 EIGHTH DAY OF PASSOVER SCHOOL CLOSED	25 SCHOOL REOPENS Report Cards Sent Home	26 Sex Hyg. Mtg., Shaw, 8:00 p.m. Pre-School Mtg., Forest, 3:00 p.m. Reg. for school budget vote, 4-10 p.m. each school	27 Reg. for next year's Kindergarten, each school, 9-11 a.m.	28 Vision Screening, Shaw, a.m.
29	30 Dist. No. 30 Bd. of Ed. Mtg., 8:15 p.m.	<p>DON'T LOSE FAITH IN HUMANITY: Think of all the people in the United States who never played you a nasty trick. — Elbert Hubbard</p> <p>Lord, when we are wrong, make us willing to change, and when we are right, make us easy to live with. — Peter Marshall</p> <p style="text-align: right;">— Copyright</p>				

SCHOOL POLICIES

SCHOOL HOURS

hours for grades 1, 2, and 3 are from 9:00 a.m. to 3:00 p.m.
 hours for grades 4, 5, and 6 are from 8:30 a.m. to 2:45 p.m.

LUNCH

is served beginning with the first day of school. Pupils go home for lunch, bring lunch from home, or buy the school lunch in the cafeteria for 40c. Monthly menus are provided so if foods are served which your child does not eat, you can eat other provisions for him for those days. In case a child forgets his lunch money or his lunch, or loses either, we have a system to cover the emergency. The cashier in the cafeteria keeps the record of such charges and contacts the parents if a charge not be paid in a reasonable time.

ICE CREAM

Ice cream is sold daily to those pupils who wish it. It is not sold with the hot lunch and costs an additional 10c.

RECESS MILK

Recess milk is available to all children beginning about the first week of the school year and is sold at a cost of 25c per week each Thursday for the following week. You will be billed as to the exact date. Money brought in late (Friday) cannot be accepted. In case of a child's absence, no refund is made for periods of less than a full week.

ABSENCES

If your child has been absent, State law requires that he bring a note from you explaining the absences and the date(s) of absence(s). The note should be presented to the nurse before he goes to the classroom. Please be specific. Just saying, "he was sick" is not enough. Indicate whether it was "virus," "fever," "flu," etc. A note is required for an absence due to a religious observance. A note is required for any tardiness, giving the reason. If your child contracts a contagious disease, such as mumps, measles, etc., please phone the school nurse so that she can advise the parents in your child's class that their children have been exposed. Be sure to keep the emergency card up to date so we will know whom to call should your child become ill and go home.

NOON HOUR RULES

When pupils misbehave in the cafeteria, auditorium, or on the playground during the noon hour, after repeated reminders, the teachers have the authority to exclude them from staying in school for lunch for a few days, or longer, depending on the misbehavior. If you receive such a note from us, we would appreciate your cooperation. Whether or not a mother is home during the noon hour has no bearing on this exclusion.

RELEASED TIME FOR RELIGIOUS INSTRUCTION

A Release Form signed by the parent is necessary should you want your child excused from school for religious instruction. Such forms can be obtained from your church. The time provided is the last hour of school on Wednesday afternoons.

EXITS AND ENTRANCES

Your child's class is assigned a specific exit and entrance to use. You will thus know where to meet him if you come to pick him up. Parents picking up children are asked to meet them at the exit, *not the classroom*.

ENTRANCE TIMES

Morning—All Schools	Noontime—Shaw & Forest
Grades 1, 2, & 3—8:50	Grades 1, 2, & 3—12:50
Grades 4, 5, & 6—8:20	Grades 4, 5, & 6—12:20
Noontime—Clear Stream: Grades 5 & 6—12:05	
Grades 3 & 4—12:35; Grades 1 & 2—1:05	

Because there is no supervision of the playground in the morning, we suggest you arrange your child's departure from home to allow him to arrive just in time to enter the building during the proper interval. In inclement weather he may come into the designated area five minutes before the above times.

CLASS INTERRUPTIONS

No unnecessary interruptions of classes are allowed once the day's sessions have begun. When your child forgets a book, homework, sneakers, lunch money, etc., please bring these to the office. All pupils are instructed to check with the office at lunch time for such forgotten items. In the interest of the child's all-round education, we urge you not to make a practice of bringing forgotten items to school. The child should be developing his own sense of responsibility for these things.

MAY 1973

MONDAY	TUESDAY	WEDNESDAY	THURSDAY	FRIDAY	SATURDAY
1 Anism is conviction of purpose reed or birthplace. —Theodore Roosevelt h to be happier than other this is always difficult of at- t. for we believe others to be than we are. —Montesquieu	2 VOTING ON SCHOOL BUDGET, 7 a.m.-10 p.m., All Schools PTA Ex. Bd. Mtgs., Clear Stream, 9:30 a.m. & Forest, 8:30 p.m.	3 PTA Ex. Bd. Mtg., Shaw, 1:00 p.m.	4 PTA Vision Screening, Clear Stream	5 PTA Vision Screening, Clear Stream	6 PTA Vision Screening, Clear Stream
7 Sex Hyg. Mtg., (Gr. 5 & 6) Shaw, 1:00 p.m.	8 C.H.S. Bd. of Ed. Mtg., 8:00 p.m.	9 Sex Hyg. Mtg., 5th Gr. Girls, 3:00 p.m., Shaw Teacher's Recognition Day, Clear Stream	10 Sex Hyg. Mtg., 6th Gr. Girls, Shaw, 3:00 p.m.	11 Sex Hyg. Mtg., 6th Gr. Girls, Shaw, 3:00 p.m.	12 PTA Vision Screening, Clear Stream
13 r's Day	14 Art Exhibit, Forest Road, 7:30 to 9:00 p.m.	15 Art Exhibit, Shaw Ave., 7:30 to 9:00 p.m. PTA Gen. Mtg., Clear Stream	16 Art Exhibit, Shaw Ave., 7:30 to 9:00 p.m. PTA Gen. Mtg., Clear Stream	17 Art Exhibit, Clear Stream, 7:30 to 9:00 p.m. PTA Cake Sale, Clear Stream	18 PTA Gen. Mtg., Clear Stream
19 MEMORIAL DAY SCHOOL CLOSED	20 Dist. No. 30 Bd. of Ed. Mtg., 8:15 p.m.	21 PTA Gen. Mtgs., Installation, Shaw & Forest, 8:00 p.m.	22 PTA Gen. Mtg., Clear Stream, 7:30 to 9:00 p.m. PTA Cake Sale, Clear Stream	23 PTA Gen. Mtg., Clear Stream	24 PTA Gen. Mtg., Clear Stream
25 MEMORIAL DAY SCHOOL CLOSED	26 MEMORIAL DAY SCHOOL CLOSED	27 MEMORIAL DAY SCHOOL CLOSED	28 MEMORIAL DAY SCHOOL CLOSED	29 MEMORIAL DAY SCHOOL CLOSED	30 MEMORIAL DAY SCHOOL CLOSED
31 MEMORIAL DAY SCHOOL CLOSED	32 MEMORIAL DAY SCHOOL CLOSED	33 MEMORIAL DAY SCHOOL CLOSED	34 MEMORIAL DAY SCHOOL CLOSED	35 MEMORIAL DAY SCHOOL CLOSED	36 MEMORIAL DAY SCHOOL CLOSED

The great thing in this world is not so much where we are but in what direction we are moving.
 — Oliver Wendell Holmes
 Success is not always final. If you

SCHOOL POLICIES

GYM SUITS AND SNEAKERS

Gym suits are required of pupils below the 3rd grade, but sneakers are necessary for any pupils using the gym. Boys and girls from the 3rd through 6th grades are required to wear gym suits and sneakers on the assigned gym days. The gym teachers will explain this to the pupils, but many times they do not bring correct information home.

Who **MUST PURCHASE A NEW SUIT** should buy the best ROYAL BLUE, bloomer type, with elastic bottoms, or ROYAL BLUE shorts with elastic insert in the cuff, and a white shirt. Boys should wear ROYAL BLUE shorts, with elastic top, and sneakers (high top ones preferred), and white or SCHOOL "T" shoes.

Who **HAS ANOTHER COLOR, OR TYPE, HE DOES NOT NEED TO BUY A NEW ONE.** The above apparel may be purchased at many local stores in Valley Stream. **NO ONE IS ALLOWED ON THE GYM FLOOR WITHOUT SNEAKERS.**

APPOINTMENTS WITH TEACHERS

Remember that pupils' classtime be used to the fullest advantage, and request that parents do not seek conferences with teachers during school hours. If you wish a conference, please make an appointment to see the teacher after school. Teachers are available for such conferences every day except Wednesdays and Fridays.

BICYCLES

Bicycles are allowed at either Forest Road or Clear Stream Schools because no child lives far enough from the school to make them necessary. They are allowed at Shaw, but are restricted to pupils in grades 4, 5, and 6 who live NORTH OF SHAW AVENUE. Bicycles used to come to the Shaw Avenue School will be assigned a number. All must have a lock and helmet for safety purposes.

GIFTS TO TEACHERS PROHIBITED

Policy of the school district which became effective Jan-1956, is to prohibit the acceptance of gifts by faculty members on school premises, and to prohibit the solicitation of funds for personal gifts purposes, by any person, or persons on the premises.

IN-DAY PROGRAM

In inclement weather, there is an in-day program of motion pictures provided for those pupils who eat in the cafeteria. Pupils who go home to lunch are not allowed to participate in this program because of space limitations, so we ask parents to return these pupils to school on such days just in time for the afternoon session—not before 12:50 p.m. for grades 1 to 3, and 12:20 p.m. for grades 4 to 6 at Shaw and Forest; and not before 12:05 for grades 5 and 6, 12:35 for grades 3 and 4, and 1:05 for grades 1 and 2 at Clear Stream.

HOMEWORK REQUIREMENTS

Homework is required of all pupils, but it will vary from day to day. First and second grade pupils may have fifteen to twenty minutes of homework per day, while third and fourth grade pupils are likely to have thirty to forty minutes. Fifth and sixth graders are expected to devote as much as an hour to homework, but again this may not be every day—it will depend on the pupil and his needs.

LOST AND FOUND

Unmarked articles lost by pupils are placed in the Lost-and-Found, which is in the Nurse's Office at Shaw & Forest, and the custodian's office at Clear Stream. Such articles, if not claimed at the end of the school year, are given to a charitable organization. However, any article bearing a child's name is returned directly to him. Please place your child's name on all his belongings.

STAYING AFTER SCHOOL

To eliminate any confusion or problems, the school may have your child every day for an additional half hour. During this half hour beyond the regular school day, the teacher may schedule your child for special help or keep him for any of several reasons. We ask that you keep this in mind and not schedule dental appointments, dancing lessons, etc. until after that interval. Teachers are also available to parents during the half hour after school, except on Wednesday and Friday, for conferences.

ASSEMBLIES

When your child's class puts on the assembly, we welcome your attendance, but we do ask you not to bring pre-school children. As much as we realize that it is a thrill for them to see big brother perform, they are often distracting to all concerned. Picture taking is not allowed without prior approval.

JUNE 1973

SUNDAY	MONDAY	TUESDAY	WEDNESDAY	THURSDAY	FRIDAY	SATURDAY
					1	2
We never know what ripples of healing we set in motion by simply smiling on one another. — Henry Drummond						
He that has no fools, knaves, nor beggars in his family was begot by a flash of lightning. — Thomas Fuller						
The most important single ingredient in the formula of success is knowing how to get along with people. — Theodore Roosevelt						
3	4 PTA Council Mtg., Memorial J.H.S., 8:00 p.m.	5	6 PTA Ex. Bd. Mtg., Shaw, 1:00 p.m. Teachers Recognition Day Luncheon, Forest	7 PTA Joint Ex. Bd. Mtg., Clear Stream, 8:00 p.m.	8	9
10	11	12 C.H.S. Bd. of Ed. Mtg., 8:00 p.m.	13 PTA Ex. Bd. Mtg., Forest, 8:30 p.m.	14 FLAG DAY	15	16
17 MOTHER'S DAY	18	19	20 Closing Exercises for 6th Grade	21	22 LAST DAY OF SCHOOL	23
24	25 Annual School Census Begins	26 Dist. No. 30 Bd. of Ed. Mtg., 8:15 p.m.	27	28	29	30

SHAW AND WASHINGTON AVENUE SCHOOLS

CLASS MOTHER LIST

Class Mother Chairman Marie DiGiamo, LO 1-0079

Class Mother	Tel. Number	Teacher
Kindergarten Representative	Susan Jacobs, 872-3144	
AM Mrs. Audino	285-6212	Miss Stelzer
AM Mrs. Chmurzynski	285-7209	Miss Blessinger
PM Mrs. Musto	872-3247	Miss Blessinger
PM Mrs. Giacalone	825-3854	Miss Starler
1st Grade Representative	Ginny Kropas, 872-8117	
Mrs. Abandolo	285-7792	Mrs. Hartman
Mrs. Ingargiola	CU 5-5162	Mrs. Lazar
Mrs. Salvaggio	825-7896	Mrs. Levine
Mrs. Kelly	825-0113	Mrs. Barra
Mrs. Maglione	825-7440	Miss Laraway
2nd Grade Representative	Lonnie DiLuccio, LO 1-6837	
Mrs. Viviano	285-7167	Miss Shapiro
Mrs. Schlaeger	CU 5-7588	Mrs. Okpych
Mrs. Lynch	872-3887	Miss Cohen
Mrs. Fennenboch	825-7419	Mrs. Erbig
3rd Grade Representative	Anita Filosa, LO 1-0074	
Mrs. Filosa	LO 1-0074	Mrs. Sweet
Mrs. Hadjiyane	CU 5-7434	Mrs. Strumpf
Mrs. Keenan	CU 5-6068	Mrs. Stevens
Mrs. Duffe	LO 1-9291	Mrs. Curtin

Gr.	Room	Class Mother	Tel. Number	Teacher
4th Grade Representative		Ruth Cohen, VA 5-4381		
4	108	Mrs. Audino	285-6212	Mrs. King
4	109	Mrs. Baumgardner	561-0138	Mrs. Benedetto
4	110	Mrs. Ingargiola	CU 5-5162	Mr. Riccobono
4	114	Mrs. Cohen	VA 5-4381	Mrs. Stiefel
5th Grade Representative		Lee Short, 825-5019		
5	116	Mrs. Sbashnig	285-6623	Miss Schwartz
5	118	Mrs. Schlaeger	CU 5-7588	Mrs. Hamcke
5	121	Mrs. Genova	825-7894	Mrs. Seid
5	122	Mrs. Short	825-5019	Mr. Beyer
6th Grade Representative		Maureen Pascale, 825-0303		
6	123	Mrs. Yannetti	VA 5-3180	Miss Visentin
5	124	Mrs. Purrazzella	CU 5-8542	Mrs. Sherman
6	125	Mrs. DiGiamo	LO 1-0079	Mrs. Rosche
6	127	Mrs. Cook	872-6079	Mr. Giacalone
Special	Cl. 131	Mrs. Clarelli	599-6528	Mrs. Lewis

JULY 1973

SUNDAY	MONDAY	TUESDAY	WEDNESDAY	THURSDAY	FRIDAY	SATURDAY
1	2	3	4 INDEPENDENCE DAY	5	6	7
8	9	10	11	12	13	14
15	16	17	18	19	20	21
22	23	24 Dist. No. 30 Bd. of Ed. Mtg., 8:15 p.m. (Tentative)	25	26	27	28
29	30	31	For all your days prepare, And meet them ever alike: When you are the anvil, bear— The best inheritance a parent can give to his When you are the hammer, strike. — Edwin Markham children is a few minutes of each day. I don't know what your destiny will be, but one thing I know: the only ones			

CLEAR STREAM AVENUE SCHOOL

CLASS MOTHER LIST

Grade	Room	Class Mother	Tel. Number	Teacher
*Kindergarten Representative Eileen Calandrino, 825-6778				
K	8:30 a.m.	Stella Rusinyak	285-8094	Miss Starler
K	8:30 a.m.	Eileen De Acetes	872-8168	Miss Starler
K	11:00 a.m.	Bernice Castello	561-0241	Miss Eden
K	11:00 a.m.	Mary Frost	561-0889	Miss Eden
K	1:30 p.m.	Sue Farrell	872-8026	Miss Eden
K	1:30 p.m.	Lenore Vita	285-5394	Miss Eden
*1st Grade Representative Rose McMeekin, 285-4925				
1	B	Marie Cusumano	VA 5-4956	Mrs. Schaaf
1	B	Stephanie Gladkowski	825-8205	Mrs. Schaaf
1	B	Pat Lynch	825-5958	Mrs. Schaaf
1	B	Madeline Weiss	825-1719	Mrs. Schaaf
1	7	Jean Blohm	285-8892	Mrs. Lauria
1	7	Ann Ciaramella	285-5072	Mrs. Lauria
1	7	Linda Dysart	285-9493	Mrs. Lauria
1	7	Fran Gleason	285-9067	Mrs. Lauria
*2nd Grade Representative Beverly Jablonowski, 825-2489				
2	6	JoAnn La Barbera	285-9820	Mrs. Guberman
2	6	Marie Boyle	825-7599	Mrs. Guberman
2	6	JoAnn Esposito	285-8815	Mrs. Guberman
2	6	Marilyn Palazzo	872-3372	Mrs. Guberman
2	5	Blanche Bartsch	LO 1-6034	Mrs. Galati
2	5	Barbara Bevacqua	872-3504	Mrs. Galati
2	5	Fran Ciniglio	285-7996	Mrs. Galati
2	5	Stephanie Klein	825-0151	Mrs. Galati
2	2	Rose La Russo	872-8079	Miss Schindelmann
2	2	Marie Pascuzzi	825-8401	Miss Schindelmann
2	2	Regina Schneider	872-8409	Miss Schindelmann
2	2	Beverly Jablonowski	825-2489	Miss Schindelmann
*3rd Grade Representative Jean Savarese, 285-5116				
3	4	Elaine Cirenza	285-5671	Mrs. Quinn
3	4	Nettie Ghiradella	561-9450	Mrs. Quinn
3	4	Jennie Tretola	872-9527	Mrs. Quinn
3	4	Jean Savarese	285-5116	Mrs. Quinn
3	1	Marie Acquavella	825-2272	Miss Firpo
3	1	Joan Bastone	285-5040	Miss Firpo
3	1	Ann Docar	285-8914	Miss Firpo
3	1	Rose Ann Potter	872-9337	Miss Firpo
3	A	Terry DiGregorio	561-9407	Miss Patterson
3	A	Ann Impelizzeri	285-5510	Miss Patterson
3	A	Connie Magrino	285-7837	Miss Patterson
3	A	Julie Sagginareo	285-8670	Miss Patterson
*4th Grade Representative JoAnn La Barbera, 285-9820				
4	23	Eleanor King	LO 1-6824	Mrs. Galbraith
4	23	Carolyn Hand	825-9660	Mrs. Galbraith
4	23	Stella Rusinyak	285-8094	Mrs. Galbraith
4	3	Lois Barry	CU 5-8654	Mrs. Cummings
4	3	Gloria Corradi	CU 5-8255	Mrs. Cummings
4	3	Connie Deering	CU 5-8210	Mrs. Cummings
4	3	Gertrude Barewald	872-3253	Mrs. Cummings
4	8	Rose Bochichio	285-4868	Miss Yelland
4	8	Barbara Bevacqua	872-3504	Miss Yelland
4	8	Beverly Jablonowski	285-2489	Miss Yelland
4	8	Merrily Spagnolia	872-0918	Miss Yelland
*5th Grade Representative Mary Ammann, CU 5-6090				
5	28	Mary Ann Boody	561-0029	Mrs. Gerdyk
5	28	Dolly Make	872-3007	Mrs. Gerdyk
5	28	Rose McMeekin	285-4925	Mrs. Gerdyk
5	28	Ann Prisco	CU 5-5744	Mrs. Gerdyk
5	27	Elaine Dysart	285-5716	Mrs. Wiesen
5	27	Betsy Mulato	285-6048	Mrs. Wiesen
5	27	Mary Reising	VA 5-5001	Mrs. Wiesen
5	27	Kay Schmidt	872-8692	Mrs. Wiesen

*Grade Coordinator

5	25	Terry Annarumma	285-9336	Mr. Camilleri
5	25	Fay Birbeglia	CU 5-9439	Mr. Camilleri
5	25	Barbara McLaughlin	825-6162	Mr. Camilleri
5	25	Dorothy Walz	825-8011	Mr. Camilleri
*6th Grade Representative Marie Pascuzzi, 825-9401				
6	21	Rosalie Ciullo	LO 1-1925	Mr. Cooper
6	21	Theresa Fileccia	LO 1-0938	Mr. Cooper
6	21	Hilda Flynn	VA 5-6081	Mr. Cooper
6	21	Marie LoRosi	285-8020	Mr. Cooper
6	22	Pat Collins	CU 5-8839	Miss Melzer
6	22	Terry Keller	CU 5-7016	Miss Melzer
6	22	Barbara Passaro	825-1608	Miss Melzer
6	22	Jean Savarese	285-5116	Miss Melzer
6	24	Marge Croak	VA 5-9352	Miss Lanell
6	24	Jeanette Ermier	VA 5-6368	Miss Lanell
6	24	JoAnn La Barbera	285-9820	Miss Lanell
6	24	Muriel Watterson	825-5478	Miss Lanell

FOREST ROAD SCHOOL

CLASS MOTHER LIST

Class Mother Chairmen

Trena Danels, 791-1506 and Paulette Kirschenbaum, 791-7045

Grade	Room	Class Mother	Tel. Number	Teacher
K	AM	201 Chickie Heym	561-7237	Mrs. Murray
K	AM	201 Rochelle Ladetsky	791-3995	Mrs. Murray
K	PM	201 Marsha Gordon	791-2863	Mrs. Murray
K	PM	201 Rochelle Koval	791-1232	Mrs. Murray
*K	PM	201 Betty Sabbatini	791-8165	Mrs. Murray
1	203	Marilyn Sparber	791-6837	Miss Caifso
*1	203	Estelle Glazer	791-5308	Miss Caifso
1	204	Ruth Clayman	791-3934	Mrs. Kalhofer
1	204	Sheila Boritz	791-9886	Mrs. Kalhofer
*2	205	Evelyn Grabois	791-1604	Mrs. Williams
2	205	Marie Briody	791-5817	Mrs. Williams
2	205	Rhoda Blaustein	791-6475	Mrs. Williams
2	206	Phyllis Finkle	791-2568	Miss Post
2	206	Anita Suriani	791-3960	Miss Post
*3	207	Edith Magee	LO 1-7064	Mrs. Cummings
3	207	Abby Tedesco	791-2157	Mrs. Cummings
3	209	Florence Goldberg	791-7746	Miss Clarke
3	209	Ginnie Levine	872-9165	Miss Clarke
4	211	Nancy Cesta	791-8028	Mrs. Inwald
4	211	Ruth Bazil	791-8556	Mrs. Inwald
*4	210	Corky Shaw	791-8807	Miss Bendin
4	210	Bea Spector	791-5216	Miss Bendin
5	216	Marsha Horowitz	791-3529	Mrs. Bratt
5	216	Betty Franey	791-9460	Mrs. Bratt
5	218	Doris Bernanke	791-3790	Mrs. Caravaggio
5	218	Evelyn Perry	791-8898	Mrs. Caravaggio
5	218	Bernice Eisenberg	791-6792	Mrs. Caravaggio
6	215	Phyllis Wolin	791-8120	Mrs. Kessler
6	215	Ellie Klein	791-3060	Mrs. Kessler
6	217	Marion Lowenbraun	791-3980	Mrs. Melnick
6	217	Marsha Goldman	791-8929	Mrs. Melnick
*6	220	Pearl Lustbader	791-9854	Mr. Kaufmann
6	220	Marlyn Fogel	791-4701	Mr. Kaufmann
6	220	Alberta Schectman	791-3471	Mr. Kaufmann
6	220	Marsha Balaban	791-7598	Mr. Kaufmann

*Grade Coordinator

AUGUST 1973

MONDAY	TUESDAY	WEDNESDAY	THURSDAY	FRIDAY	SATURDAY
what you eat that causes ulcers; it's what's eating		1	2	3	4
are no degrees of honesty. — Capt. Eddie Rickenbacker					
child comes with the message that God is not yet raged with man. — Tagore					
5	6	7	8	9	10
12	13	14	15	16	18
	C.H.S. Bd. of Ed. Mtg., 8:00 p.m.				
19	20	21	22	23	25
26	27	28	29	30	31
	Dist. No. 30 Bd. of Ed. Mtg., 8:15 p.m.				

**UNION FREE SCHOOL DISTRICT No. 30 AND
CENTRAL HIGH SCHOOL DISTRICT No. 1,
VALLEY STREAM, NEW YORK**

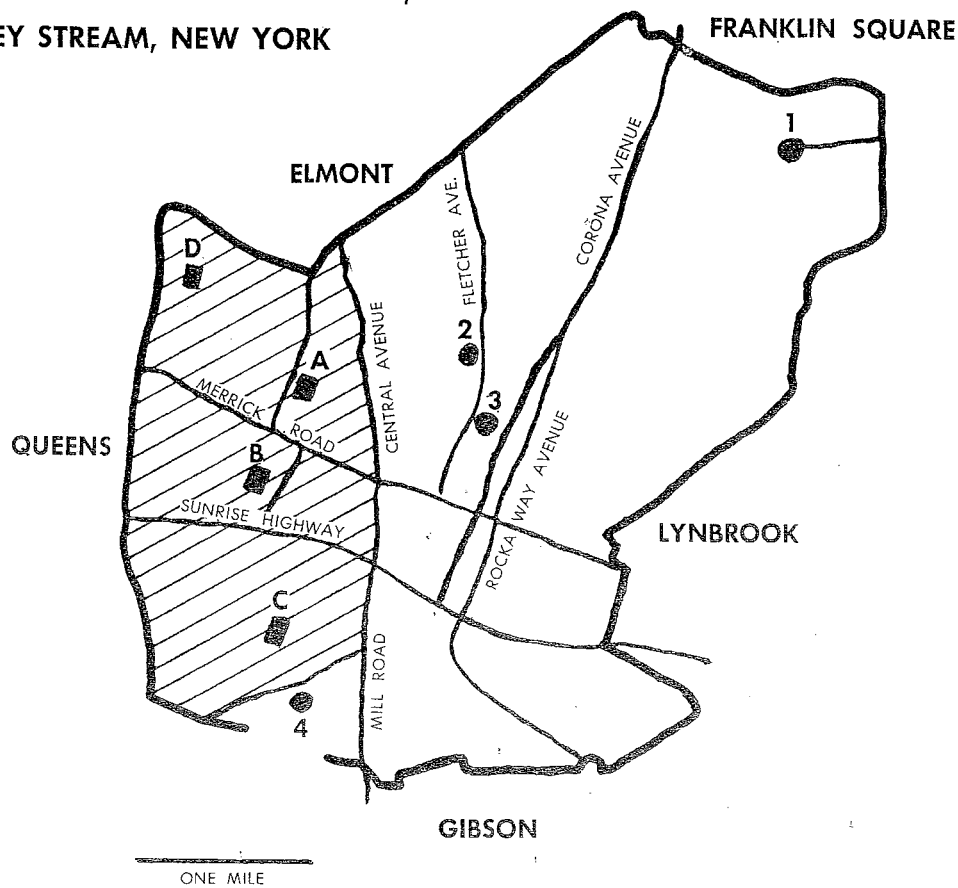

DISTRICT No. 30 SCHOOLS

Shaw Avenue	A
Clear Stream Avenue	B
Forest Road	C
Washington Avenue	D

Shaded Area — District 30

HIGH SCHOOLS

North High	1
Memorial Junior	2
Central High	3
South High	4

SCHOOL TELEPHONE DIRECTORY

OFFICE: SHAW AVENUE SCHOOL	
Principal	VA 5-9131
Office	VA 5-9131
Business Manager	VA 5-9131
Forest Stream Avenue School	
Principal's Office	VA 5-3044
Office	VA 5-3044
Washington Avenue School	
Principal's Office	PY 1-7676
Office	PY 1-7676

Shaw Avenue School	
Principal's Office	VA 5-9131
Nurse's Office	VA 5-9131
Washington Avenue School	
Office	VA 5-9131
Special Services	
Administrative Assistant/Curriculum	VA 5-9131
Psychologist	VA 5-9131
Speech Consultant	VA 5-9131
Reading Consultant	PY 1-7676
Audio-Visual Consultant	LO 1-1165

INDEX

Board of Education and School Calendar	see October
Administration and Special Services	see November
Clear Stream PTA	see December
Shaw and Washington Avenue PTA	see January
Forest Road PTA	see February
The Development of Perceptual Skills	see March
Parents as Models for Children's Speech	see April
School Policies	see May and June
Shaw and Washington Class Mothers	see July
Clear Stream and Forest Class Mothers	see August
Map of the District	see facing page

CENTRAL HIGH SCHOOL DISTRICT NO. 1
Telephone Number: VA 5-8642
Use this number for all high school buildings, offices and personnel

NOTES

FOR 1972-1973

Calendar

SCHOOL ACTIVITIES

UNION FREE SCHOOL DISTRICT THIRTY
VALLEY STREAM, NEW YORK

UNION FREE SCHOOL DISTRICT THIRTY
VALLEY STREAM, NEW YORK

30

SCHOOL ACTIVITIES

Calendar

FOR 1973-1974

PUBLISHED BY THE BOARD OF EDUCATION AND PARENT TEACHER ASSOCIATION

TELEPHONE DIRECTORY

INDEX

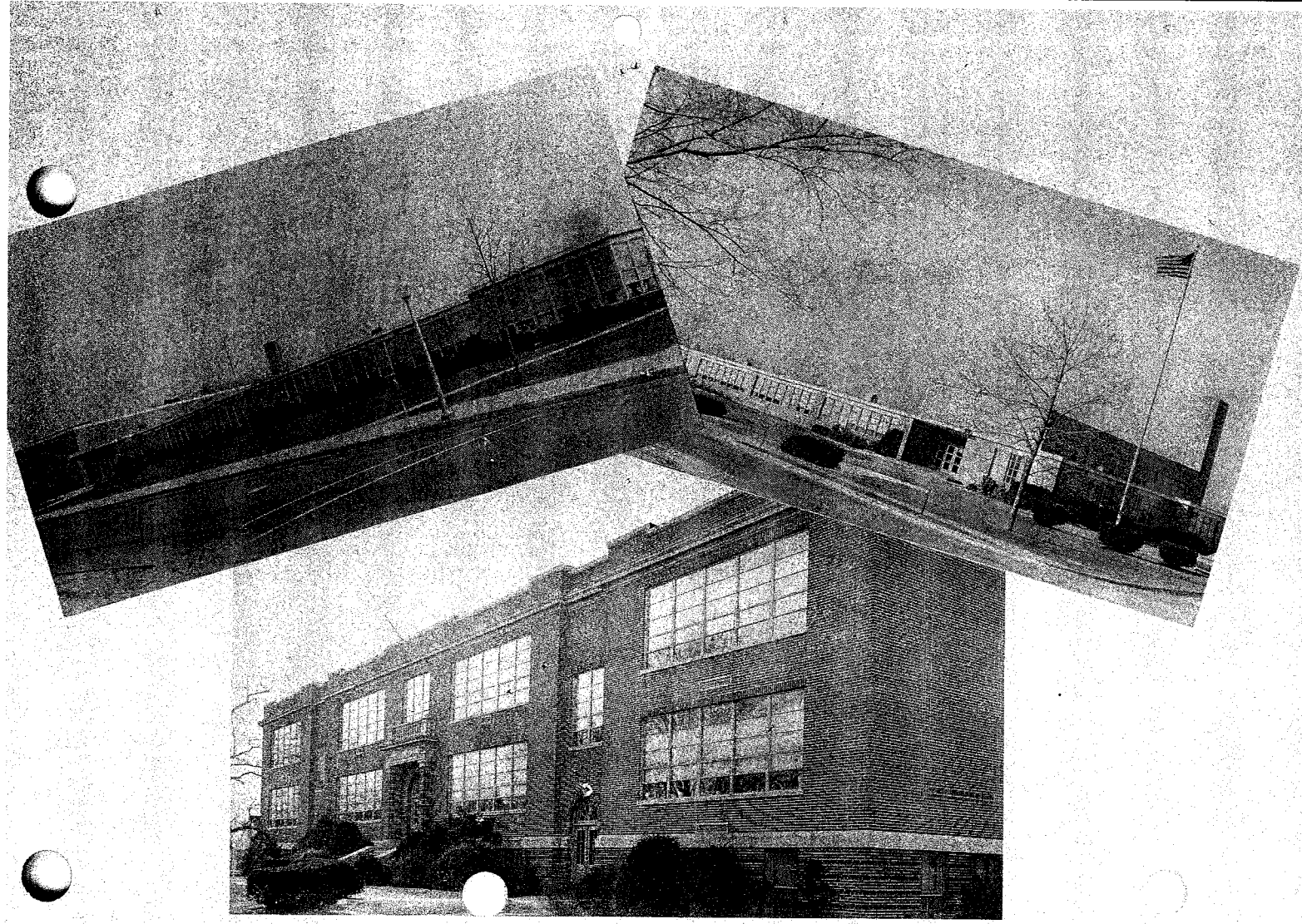

SEPTEMBER 1973

SUNDAY	MONDAY	TUESDAY	WEDNESDAY	THURSDAY	FRIDAY	SATURDAY
						1
2	3 LABOR DAY	4 Faculty Meeting	5 SCHOOL OPENS PTA Book Cover Sale, Clear Stream, 2:45 P.M.	6 PTA Ex. Bd. Mtg., Clear Stream, 9:30 A.M. Book Cover Sale, Clear Stream, 2:45 P.M.	7	8
9	10	11 C.H.S. Bd. of Ed. Mtg., 8:00 P.M. Class Mothers' Mtg., Forest, 8:30 P.M. Parents' Night, Wash., 8:15 P.M.	12 PTA Ex. Bd. Mtg., Shaw, 1:00 P.M.	13 Ex. Bd. & Class Mother Mtg., Clear Stream, 9:30A.M. Parents' Night, Shaw, 8:15 P.M.	14	15
16	17	18 Bowling Starts, Forest, 12:30 P.M. PTA Sweat Shirt Sale, Shaw & Washington	19 "Meet the Teacher Nite", Forest, 8:30 P.M.	20 PTA Gen. Mtg., Clear Stream, 8:00 P.M. Parents' Night, Shaw, 8:15 P.M.	21	22
23	24 Parents' Night, (K-3) Clear Stream	25 Dist. #39 Bd. of Ed. Mtg. 8:15 P.M.	26	27 ROSH HASHANAH SCHOOL CLOSED	28 ROSH HASHANAH SCHOOL CLOSED	29

somehow cling to the wondrous fancy, that in all men hiddenly reside certain wondrous, occult properties . . . which by some happy but rare accident (as bronze was discovered by the melting of iron and brass in the turning of Corinth) may chance to be called forth. — Herman Melville

BOARD OF EDUCATION



Standing (left to right): Eleanor Zeller, Board Clerk; George Adams, School Attorney; Joseph Barry, Vice President; Eleanor Berger, Board Treasurer; Sherwood Quick, District Principal. Seated: James R. Smith*, President; Nathaniel Altschul*, Elinor McAuliffe*, Robert Bell.
 *Also serves on High School Board.

SCHOOL CALENDAR, 1973-1974

City Meetings	Tues., Sept. 4	Winter Recess	Mon., Feb. 11
Schools Open for Students	Wed., Sept. 5	(Includes Lincoln's & Washington's Birthdays)	
Hashanah	Thurs., Fri., Sept. 27, 28	Reopen	Tues., Feb. 19
Columbus Day	Mon., Oct. 8	Easter Recess	Mon., Apr. 8
Trans' Day	Mon., Oct. 22	(Includes all Passover Days)	
Thanksgiving Recess	(Close of A.M. Session) Wed., Nov. 21	Reopen	Mon., Apr. 15
	Reopen	Memorial Day	Mon., May 27
Christmas Recess	Mon., Nov. 26	Last Day of School	Fri., June 21
	Mon., Dec. 24		
	Reopen		
	Wed., Jan. 2		

OCTOBER 1973

SUNDAY	MONDAY	TUESDAY	WEDNESDAY	THURSDAY	FRIDAY	SATURDAY
	1 PTA Council Mtg., 8:00 P.M., Wheeler Avenue	2 Parents' Night, (4-6) Clear Stream, 7:30 P.M.	3 PTA Ex. Bd. Mtg., Forest, 8:30 P.M. PTA Gen. Mtg., Shaw, 8:00 P.M.	4 PTA Ex. Bd. Mtg., Clear Stream, 9:30 A.M.	5 Cultural Arts Assembly, Shaw	6 YOM KIPPUR
7	8 COLUMBUS DAY SCHOOL CLOSED Childrens' Movie, Clear Stream, 1:00 P.M.	9 C.H.S. Bd. of Ed. Mtg., 8:00 P.M.	10	11 First Day of Sukkoth	12	13
14	15	16 Jelly Apple Sale, Clear Stream, 2:45 P.M.	17 Hoshana Rabba Jelly Apple Sale, Clear Stream, 2:45 P.M.	18 Shemini Atzereth	19 Simhath Torah	20
21	22 VETERANS DAY SCHOOL CLOSED Childrens' Movie, Clear Stream, 1:00 P.M.	23 Dist. #30 Bd. of Ed., Mtg., 8:15 P.M.	24 PTA Gen. Mtg., Forest, 8:30 P.M.	25	26 6th Gr. Hallowe'en Party, Forest	27
28	29	30	31 HALLOWE'EN 5th & 6th Gr. Hallowe'en Party,	It would seem quite apparent that there is no <i>one</i> creative process, and there may well be as many creative processes as there are creative people. — H. Herbert Fox		

SCHOOL ADMINISTRATION

Dr. William T. Callahan, *District Superintendent*

Sherwood S. Quick
District Principal

SCHOOL PRINCIPALS

CLEAR STREAM AVENUE SCHOOL
Richard M. Burbell

FOREST ROAD SCHOOL
Maurice E. St. Mary

SHAW AVENUE SCHOOL
Lawrence Cid

William J. Van Ness, *Administrative Assistant/Curriculum*
George W. Niederhauser, *Administrative Assistant/Business*

SCHOOL SECRETARIES

Jeanne Feeney, *Clear Stream Avenue*
Mary McDowell, *Forest Road*
Jean Annona, *Shaw Avenue*

DISTRICT SECRETARIAL STAFF

Margaret Bradley Lucy Felice Mary Ribando
Annie O'Connell Gloria Zweier Caroline Young
Edythe Sanchez

Evelyn Pearn, *Cafeteria Manager*

DISTRICT SPECIALISTS AND SPECIAL TEACHERS

Frank DeMarco, *Director of Educational Communications*
Rosalyn Kessler, *Psychologist*
Estelle Friedman, *Psychologist*
Raydine Teicheira, *Speech Consultant*
Frances Pollet, *Speech Teacher*
Susan Wasserman, *Foreign Language Consultant*
Henry Kohlmann, *Instrumental Music Teacher*
Barbara Epstein, *Instrumental Music Teacher*

OTHER SPECIALISTS AND SPECIAL TEACHERS

Clear Stream Avenue School

Cathleen Meneilly, *Special Counselor*
Janet Poppe, *Reading Specialist*
Grace Giacobone, *Art*
Philip Hessemer, *Physical Education*
Charles Parker, *Physical Education*
Linda Pratt, *Music*
Ruth Newman, *Library Media Specialist*
To Be Announced, *Nurse-Teacher*

Forest Road School

Helen Fink, *Special Counselor*
Ada Keaney, *Reading Consultant*
Eileen Goldsmith, *Art*
Alfred Stevens, *Physical Education*
Charles Parker, *Physical Education*
Frances Gibson, *Music*
Rose Agree, *Library Media Specialist*
Hilda Rosenfeld, *Nurse-Teacher*

Shaw Avenue School

Noel Giambalvo, *Special Counselor*
Jeanne Colton, *Reading Specialist*
Rosemary Williams, *Reading Teacher*
Linda Sleiertin, *Art*
Anita Lafayette, *Art*
Thomas Rouse, *Physical Education*
Linda Kelly, *Physical Education*
Kathryn Egan, *Music*
Barbara Briker, *Music*
Sylvia Berkowitz, *Library Media Specialist*
Dorothy McCutchan, *Nurse-Teacher*

NOVEMBER 1973

SUNDAY	MONDAY	TUESDAY	WEDNESDAY	THURSDAY	FRIDAY	SATURDAY
				1 PTA Ex. Bd. Mtg., Clear Stream, 9:30 A.M.	2	3
4	5	6 ELECTION DAY SCHOOL OPEN	7 PTA Ex. Bd. Mtg., Forest, 8:30 P.M. Hygiene Film, 5th Gr. girls, Clear Stream, 3:00 P.M. PTA Ex. Bd. Mtg., Shaw, 1:00 P.M.	8 PTA Gen. Mtg., Clear Stream, 8:00 P.M.	9	10 PTA Movie, Shaw
11	12	13 C.H.S. Bd. of Ed. Mtg., 8:15 P.M.	14 Pre-School Mtg., Forest, 3:00 P.M. Teacher Recognition Day Luncheon, Shaw	15	16 PTA Fashion Show at Cooky's Green Acres, Clear Stream PTA, 7:30 P.M.	17
18 Pre-School Mtg., Shaw & Washington, 3:00 P.M.	19	20	21 SCHOOL CLOSES AT NOON	22 THANKSGIVING DAY SCHOOL CLOSED	23 SCHOOL CLOSED	24
25	26	27 Dist. #30 Bd. of Ed. Mtg., 8:15 P.M.	28 PTA Gen. Mtg., Forest, 8:15 P.M.	29	30	

find that images appear only if we give our ideas uncontrolled freedom when we are dreaming while awake. As soon as full consciousness, unitary consciousness returns, images weaken, darken; they seem to withdraw to some unknown region. — Alfred Binet

CLEAR STREAM AVENUE PARENT TEACHER ASSOCIATION

ELECTED OFFICERS 1973-1974

Co-President	Dorothy Walz	825-8011
Co-President	Irene Wood	872-8627
First Vice President	Terry Keller (Program)	285-7016
Second Vice President	Rose McMeekin (Pre-School)	285-4925
Treasurer	Connie Deering	285-6210
Membership	Beverly Jablonowski	825-2489
Recording Secretary	Stephanie Klein	825-0151
Corresponding Secretary	Sue Farrell	872-8026
Delegates to Council	Marilyn Palazzo	872-3372
	Miss Poppy	Faculty
	Marie Li Rosi	285-8020
	Marge Croak	825-9352
Past Presidents	Margaret Carlson	285-8857
	Marilyn Margolies	285-9465

COMMITTEE CHAIRMEN

Arts and Flyers	Gloria Corradi	285-5255
Typing	Marge Croak	825-9352
Audio-Visual	Frank DeMarco	Faculty
Budget	Jean Savarese	285-5116
Cultural Arts	Mrs. Linda Pratt	Faculty
Health	Ann Docar	CU 5-8914
Juvenile Protection	Marie Boyle	825-7509
Historian	Miss Melzer	Faculty
Legislation	Mary Ann Boody	561-0029
Mimeographers	Marilyn Margolies	285-9465
	Margaret Carlson	285-8857
	Terry Annaruma	285-9336
	Netti Ghiardella	561-6450
School & Community	Mary Ammann	285-6090
Pre-School	Dominick DeCandia	825-7242
	Rose McMeekin	285-4925
Sunshine	Stephanie Klein	825-0151
THE STREAMER—Editor	Ann Prisco	285-5744
Distribution	Dorothy Fusco	CU 5-5526
Ways & Means	Terry Annaruma	285-9336
Fashion Show	Kay Ciccione	LO 1-9207
Cake Sale	Connie Deering	285-6210
Jelly Apple Sale	Mary Ammann	285-6090
	Fran Carnavale	
Bowling	Rosemary Koncelerski	
	Evelyn McGowan	285-6222
Movies	Marie Grande	LO 1-1848
	Mary Tragner	285-9502
	Ann Prisco	285-5744
	Gloria Corradi	285-5255
Hospitality	Eileen Calandrino	825-6778
	Kay MacDonald	825-3313
	Sheryl Holton	561-9055
	Marie Li Rosi	285-8020
Publicity	Marie Pascuzzi	825-8401
Publications	Jean Savarese	285-5116
Grade Rep. Chairman	Lois Barry	285-8654

Kindergarten Rep.
1st Grade Rep.
2nd Grade Rep.
3rd Grade Rep.
4th Grade Rep.
5th Grade Rep.
6th Grade Rep.

Ann Prisco	285-5744
Eileen Calandrino	825-6778
Rose McMeekin	285-4925
Beverly Jablonowski	825-2489
Jean Savarese	285-5116
Mary Tragner	285-9502
Mary Ammann	285-6090

P.T.A. PROGRAM

Special Note: There will be a bowling league from Clear Stream that will meet on Tuesdays at the Green Acres Bowling Alley beginning Sept. 11th at 10 A.M. Car pools are arranged for kindergarten mothers. There will also be a Junior Bowling League for boys and girls in the 4th thru 6th grades that will meet on Monday afternoons after school (3:00-3:15) at the same bowling alley.

Sept.	5	Book Cover Sale, 2:45 P.M.
	6	Executive Board Meeting, 9:30 A.M.
	6	Book Cover Sale, 2:45 P.M.
	13	Executive Board and Class Mother Meeting, 9:30 A.M.
	20	General Meeting, 8:00 P.M.
	24	Parents' Night (K-3), 7:30 P.M.
Oct.	2	Parents' Night (4-6), 7:30 P.M.
	4	Executive Board Meeting, 9:30 A.M.
	8	Children's Movie, 1:00 P.M.
	16	Jelly Apple Sale, 2:45 P.M.
	17	Jelly Apple Sale, 2:45 P.M.
	22	Children's Movie, 1:00 P.M.
	31	Halloween Party for 5th and 6th grades
Nov.	1	Executive Board Meeting, 9:30 A.M.
	7	Hygiene Film for 5th grade girls, 3:00 P.M.
	8	General Meeting, 8:00 P.M.
	16	Fashion Show at Cooney's Restaurant, Green Acres, 7:30 P.M.
Dec.	6	Executive Board Meeting, 9:30 A.M.
	13	PTA Holiday Assembly
Jan.	3	Executive Board Meeting, 9:30 A.M.
	17	General Meeting, 8:00 P.M.
Feb.	6	PTA Cake Sale for Children, 2:45 P.M.
	7	Executive Board Meeting, 9:30 A.M.
	27	Cultural Arts Program, 9:00 A.M.
Mar.	7	Executive Board Meeting, 9:30 A.M.
	15	Father-Son-Daughter Night, 7:30 P.M.
	21	General Meeting, 8:00 P.M.
	25	Showing of Sex Hygiene Film to 5th and 6th grade boys and girls and their parents, 7:30 P.M.
	26	Sex Hygiene Meeting, 6th grade boys & girls, 3:00 P.M.
	27	Sex Hygiene Meeting, 5th grade boys & girls, 3:00 P.M.
Apr.	4	Executive Board Meeting, 9:30 P.M.
	18	Show date—Show involving children and/or parents
	25	Hygiene Film for 4th grade girls, 3:00 P.M.
May	1	Executive Board Meeting, 9:30 A.M.
	8	Teachers' Recognition Day
	16	General Meeting & Installation of Officers, 8:00 P.M.
	23**	Art Exhibit and PTA Cake Sale, 7:30 P.M.
	**	Assuming this is in accordance with District Plans
June	6	Joint Executive Board Meeting, 8:00 P.M.

DECEMBER 1973

SUNDAY	MONDAY	TUESDAY	WEDNESDAY	THURSDAY	FRIDAY	SATURDAY
						1
2	3 PTA Council Mtg., 8:00 P.M., Brooklyn Avenue	4	5 PTA Ex. Bd. Mtg., Forest, 8:30 P.M. PTA Gen. Mtg., Shaw, 8:15 P.M.	6 PTA Ex. Bd. Mtg., Clear Stream, 9:30 A.M.	7	8
9	10	11 C.H.S. Bd. of Ed. Mtg., 8:00 P.M.	12	13 Pre-School Mtg., Forest, 2:00 P.M. PTA Holiday Assembly, Clear Stream	14 PTA Holiday Assembly, Shaw	15
16	17	18 Dist. #30 Bd. of Ed. Mtg., 8:15 P.M.	19 Music Show, Forest, 8:00 P.M.	20 HANUKKAH	21 SCHOOL CLOSURES FOR CHRISTMAS VACATION AT REGULAR TIMES	
23 CHRISTMAS EVE SCHOOL CLOSED	24	25 CHRISTMAS SCHOOL CLOSED	26 SCHOOL CLOSED	27 LAST DAY OF HANUKKAH	28 SCHOOL CLOSED	29

SHAW AND WASHINGTON AVENUES PARENT TEACHER ASSOCIATION

ELECTED OFFICERS 1973-1974

President	Diane Keenan	CU 5-8068
First Vice President	Marie Casale	825-7872
Second Vice President	Grace Pisano	872-3097
Treasurer	Louise Kiel	CU 5-9651
Recording Secretary	Mary Zeiner	285-9898
Financial Secretary	Anita Filosa	LO 1-0074
Corresponding Secretary	Grace Duffy	LO 1-9291
Delegates to Council	Kay Hadjiyane	CU 5-7434
	Gail Starler	Faculty
Past President	Jean Layden	285-7624

COMMITTEE CHAIRMEN

Audio-Visual	John Giacalone	Faculty
Budget	Stella Schlaeger	CU 5-7588
	Lee Short	825-5019
	Eileen Coughlin	825-2264
	Carmela D'Auria	285-4808
	Eleanor Nazzaro	825-4741
	Camille Audino	285-6212
Cheer	Lillian Ging	CU 5-6072
	Angela Maglioni	825-7440
Cultural Arts & Programs	Kay Hadjiyane	CU 5-7434
	Carmela D'Auria	285-4808
	Vera Manzo	872-8717
Distribution	Cathy Dwyer	CU 5-5283
Grade Rep. Coordinator	Elaine Kelly	825-0113
Historian	Lois Patronzino	285-5102
Health & Safety	Sheila Jacobs	285-9052
	Irene Inargiola	CU 5-5162
	Eleanor Nazzaro	825-4741
	Sue Magnus	825-8038
	Joan Di Cataldo	872-3666
Hospitality	Jean Yocono	VA 5-0728
	Sheila Jacobs	285-9052
	Grace Duffy	LO 1-9291
	Lorraine Tucci	825-7581
	Susan Jacobs	872-3144
	Anita Filosa	LO 1-0074
Legislation	Angela Maglioni	825-7440
	Lillian Fayet	551-6973
	Jean Layden	285-7624
	Stella Schlaeger	285-7588
Membership	Ethel Paone	285-7029
	Camille Audino	285-6212
	Jean Layden	285-7624
Mimeograph	Ethel Paone	285-7029
	Madeline Kelly	285-9543
Newsletter	Cathy Rosenbaum	285-5059
	Elaine Kelly	285-0113
Parent Education	Susan Jacobs	872-3144
Parliamentarian	Jean Layden	285-7624
Pre-School	Peggy Nugent	872-6878
	Lorraine Tucci	825-7581
	Elaine Mosca	825-0414
	Madeline Kelly	285-9543
	Grace Duffy	LO 1-9291
	Jean Layden	285-7624
	Claire Piemonte	825-8032
	Grace Pisano	872-3097
	Louise Kiel	CU 5-9651
	Vera Manzo	872-8717
	Angela Maglioni	825-7440

Ways & Means

Bowling League, Pres.	Mary Zeiner	285-9898
	Stella Schlaeger	285-7588
	Lillian Ging	CU 5-6072
Cup Cake Sale	Anita Filosa	LO 1-0074
Fashion Show	Elaine Kelly	825-0113
	Madeline Kelly	285-9543
	Cathy Rosenbaum	285-5059
	Lonnie Di Luccio	LO 1-6837
Movies	Anita Filosa	LO 1-0074
Art Auction & Sweat Shirt Sale	Marie Casale	825-7872
	Lillian Field	VA 5-8581
	Barbara Baumgardener	872-9241
	Phyllis Musto	872-3247
	Anita Filosa	LO 1-0074
	Ethel Paone	285-7029
	Angela Maglioni	825-7440
Kindergarten Rep.	Carmela D'Auria	285-4808
1st Grade Rep.	Susan Jacobs	872-3144
2nd Grade Rep.	Ginny Kropas	872-8117
3rd Grade Rep.	Lonnie Di Luccio	LO 1-6837
4th Grade Rep.	Anita Filosa	LO 1-0074
5th Grade Rep.	Cathy Rosenbaum	285-5059
6th Grade Rep.	Lee Short	825-5019

P.T.A. PROGRAM

Sept.	11	Parents' Night, Washington Avenue, 8:15 P.M.
	12	PTA Board Meeting, 1:00 P.M.
	13	Parents' Night, Shaw Avenue, 8:15 P.M.
	18	PTA Sweat Shirt Sale, Shaw & Washington Avenue
	20	Parents' Night, Shaw Avenue, 8:15 P.M.
Oct.	3	PTA General Meeting, Shaw Avenue, 8:00 P.M.
	5	PTA Cultural Arts Assembly, Shaw Avenue
Nov.	7	PTA Board Meeting, 1:00 P.M.
	10	PTA Movie, Shaw Avenue
	14	Teachers' Recognition Day Luncheon
	19	Pre-School Meeting, Shaw & Washington Ave., 3-3:30 P.M.
Dec.	5	PTA General Meeting, Shaw Avenue, 8:15 P.M.
	14	PTA Holiday Assembly, Shaw Avenue
Jan.	9	PTA Board Meeting, 1:00 P.M.
	16	Cupcake Sale, Shaw & Washington Avenue,
	21	Pre-School Meeting, Shaw & Washington Ave., 3-3:30 P.M.
Feb.	6	PTA General Meeting, Shaw Avenue, 8:00 P.M.
	23	PTA Art Auction, Shaw Avenue, 8:15 P.M.
Mar.	6	PTA Board Meeting, 1:00 P.M.
	11	Pre-School Meeting, Shaw & Washington Ave., 3-3:30 P.M.
	21	PTA Fashion Show
April	3	PTA General Meeting, Shaw Avenue, 8:00 P.M.
	5	Cultural Arts Assembly, Shaw Avenue
	20	Vision Screening, Shaw Avenue, A.M.
	25	Sex Hygiene Meeting, Fathers & 6th grade boys, 8:00 P.M.
	26	Registration for next year's kindergarten, A.M.
May	2	PTA Board Meeting, Shaw Avenue, 1:00 P.M.
	6	Sex Hygiene Meeting, 5th & 6th grade mothers, 1:00 P.M.
	8	Sex Hygiene Meeting, 5th grade girls, 3:00 P.M.
	10	Sex Hygiene Meeting, 6th grade girls, 3:00 P.M.
	29	PTA Installation Night
June	5	PTA Joint Board Meeting, 1:00 P.M.

JANUARY 1974

SUNDAY	MONDAY	TUESDAY	WEDNESDAY	THURSDAY	FRIDAY	SATURDAY
<p>no idea whence this tide comes, where it goes, but when it begins rise in my heart, I know that a is in the offing.</p> <p style="text-align: right;">— Dorothy Canfield</p>		1 NEW YEAR'S DAY SCHOOL CLOSED	2 SCHOOL REOPENS PTA Ex. Bd. Mtg., Forest, 8:30 P.M.	3 PTA Ex. Bd. Mtg., Clear Stream, 9:30 P.M.		
6	7	8 C.H.S. Bd. of Ed. Mtg., 8:00 P.M.	9 PTA Ex. Bd. Mtg., Shaw, 1:00 P.M.	10	11	12
13	14	15	16 PTA Gen. Mtg., Forest, 8:30 P.M. PTA Cupcake Sale, Shaw & Washington	17 PTA Gen. Mtg., Clear Stream, 8:00 P.M.	18	19
20	21 Pre-School Mtg., Shaw & Washington, 3:00 P.M.	22 Dist. #30 Bd. of Ed. Mtg., 8:15 P.M.	23 Pre-School Mtg., Forest, 2:00 P.M.	24	25	26
27	28	29	30	31	Creativity is defined as the ability to make new combinations of social	

FOREST ROAD PARENT TEACHER ASSOCIATION

ELECTED OFFICERS 1973-1974

<i>President</i>	Ginny Levine	872-9165
<i>First Vice President</i>	Ruth Bazil	791-8556
<i>Second Vice President</i>	Shelly Koval	791-1232
<i>Third Vice President</i>	Judy Orloff	791-3820
<i>Fourth Vice President</i>	Evelyn Grabois	791-1604
<i>Treasurer</i>	Edith Magee	LO 1-7064
<i>Financial Secretary</i>	Doris Bernanke	791-3790
<i>Recording Secretary</i>	Barbara Rovin	791-1360
<i>Corresponding Secretary</i>	Paulette Kirschenbaum	791-7045
<i>Delegates to Council</i>	Renee Pepper	791-3857
	Rhoda Blaustein	791-6475

COMMITTEE CHAIRMEN

<i>Amblyopia</i>	Judy Orloff	791-3820
	Evelyn Grabois	791-1604
<i>Bowling (Adult)</i>	Doris Bernanke	791-3790
	Felicia Katz	791-9501
<i>Bowling (Children)</i>	Doris Bernanke	791-3790
	Anita Suriani	791-3960
<i>Budget</i>	Lydia Rosen	791-5488
<i>Class Mothers</i>	Irena Danels	791-1506
	Marie Briody	791-5817
<i>Cultural Arts</i>	Irene Bochner	791-6351
<i>Children's Theatre</i>	Marie Briody	791-5817
<i>Ecology</i>	Evelyn Grabois	791-1604
<i>Family Living</i>	Abbey Tedesco	791-2157
	Florence Goldberg	791-7746
<i>Flyers</i>	Ellen Filler	872-6377
	Carol Provenzano	825-5915
<i>Goodwill</i>	Linda Zahn	791-4516
<i>Hospitality</i>	Audrey Rumph	791-5794
	Irene Bochner	791-6351
	Claire Gendelman	791-5811
<i>Health & Safety</i>	Felicia Katz	791-9501
<i>Historian</i>	Rhoda Blaustein	791-6475
<i>Legislation</i>	Toby Kaller	791-2104
<i>Membership</i>	Doris Bernanke	791-3790
<i>Mimeograph</i>	Anita Suriani	791-3960
	Kathy McClellan	872-9794
<i>Newsletter</i>	Marie Spiwok	791-3307
	Marion Lowenbraun	791-3980
<i>Parliamentarian</i>	Corky Shaw	791-8807
<i>Posters</i>	Prudy Lotierzo	791-1381
<i>Pre-School</i>	Shelly Koval	791-1232
<i>Program Chairman</i>	Ruth Bazil	791-8556
<i>Publicity</i>	Barbara Smerling	791-2540

School Bd. Rep.—Elem.
School Bd. Rep.—Hg. Sch.
Teachers Rep.
Typist
Ways & Means
Book Fair

Nancy Cesta 791-8028
 Ellie Klein 791-3060
 Hilda Rosenfeld Faculty
 Terry Schultz 561-2989

Holiday Boutique

Irene Bochner 791-6351
 Shelly Koval 791-1232
 Renee Pepper 791-3857
 Paulette Kirschenbaum 791-7045

Kindergarten Rep.
1st Grade Rep.
2nd Grade Rep.
3rd Grade Rep.
4th Grade Rep.
5th Grade Rep.
6th Grade Rep.

Evelyn Grabois 791-1604
 Paulette Kirschenbaum 791-7045
 Elaine Sandler 791-5765
 Judy Orloff 791-3820
 Renee Pepper 791-3857
 Irene Bochner 791-6351
 Doris Bernanke 791-3790

P.T.A. PROGRAM

Sept.	11	Class Mother Meeting, 8:30 P.M.
	18	Bowling Starts, 12:30 P.M.
	19	Meet the Teacher Nite, 8:30 P.M.
Oct.	3	Executive Board Meeting, 8:30 P.M.
	24	General Meeting, 8:30 P.M.
	26	6th Grade Halloween Party
Nov.	7	Executive Board Meeting, 8:30 P.M.
	14	Pre-School Meeting, 3:00 P.M.
	28	General Meeting, 8:30 P.M.
Dec.	5	Executive Board Meeting, 8:30 P.M.
	13	Pre-School Meeting, 2:00 P.M.
	19	Music Show, 8:00 P.M.
Jan.	2	Executive Board Meeting, 8:30 P.M.
	16	General Meeting, 8:30 P.M.
	23	Pre-School Meeting, 2:00 P.M.
Feb.	6	Executive Board Meeting, 8:30 P.M.
	20	Founder's Day, 8:30 P.M.
	28	Pre-School Meeting, 3:00 P.M.
Mar.	6	Executive Board Meeting, 8:30 P.M.
	20	Pre-School Meeting, 2:00 P.M.
	20	General Meeting, 8:30 P.M.
April	3	Executive Board Meeting, 8:30 P.M.
	17	General Meeting, 8:30 P.M.
	25	Pre-School Meeting, 3:00 P.M.
May	1	Executive Board Meeting, 8:30 P.M.
	8	Teachers' Recognition Day Luncheon
	15	General Meeting & Installation, 8:30 P.M.
June	5	Joint Executive Board Meeting, 8:30 P.M.

FEBRUARY 1974

SUNDAY	MONDAY	TUESDAY	WEDNESDAY	THURSDAY	FRIDAY	SATURDAY
					1	2
3	4 PTA Council Mtg., 8:00 P.M., Willow Road	5 C.H.S. Bd. of Ed. Mtg., 8:00 P.M.	6 PTA Ex. Bd. Mtg., Forest, 8:30 P.M. PTA Cake Sale for Children, Clear Stream, 2:45 P.M. PTA Gen. Mtg., Shaw, 8:00 P.M.	7 HAMISHAH ASAR BISHVAT PTA Ex. Bd. Mtg., Clear Stream, 9:30 A.M.	8	9
10	11 WINTER RECESS SCHOOL CLOSED	12 WINTER RECESS LINCOLN'S BIRTHDAY	13 WINTER RECESS SCHOOL CLOSED	14 WINTER RECESS SCHOOL CLOSED	15 WINTER RECESS SCHOOL CLOSED	16
17	18 WINTER RECESS SCHOOL CLOSED	19 SCHOOL REOPENS	20 PTA Founders' Day Mtg., Forest, 8:30 P.M. For All Schools	21	22 WASHINGTON'S BIRTHDAY	PTA Art Auction, Shaw, 8:15 P.M.
24	25	26 Dist. #30 Bd. of Ed.	27 PTA Cultural Arts Pro., Clear Stream	28 Pre-School Mtg., Forest, 2:00 P.M.	The ability to relate and to connect, sometimes in odd yet in striking fashion, lies at the very heart of any creative use of the mind no matter	

EVERYONE IS CREATIVE IN SOME WAY

Our theme for this Activity Calendar is creativity and thus all the quotations in it have to do with this subject.

In years gone by, most authorities felt that creative people were only artists, musicians, or writers, but research in recent years has pin-pointed that creativity takes place in all walks of life, not only in the field of art.

Professor Calvin Taylor of the University of Utah, has done extensive research on this subject and has identified over fifty different forms of creativity. Some may not agree with his definition of what creativity actually is but it makes sense to us.

For instance, both divergent thinking and convergent thinking are considered two forms of creativity. The person who thinks divergently will take some small idea and expand it so that many, many new ideas come from the lone original thought. A man in Research and Development for a big corporation would be a thinker of this type.

A convergent thinker is one who can take many ideas and "sift out the chaff" bringing all these ideas to a head. An editor is a thinker of this type.

Though we don't agree with all his characteristics, we here-with present John W. Haefele's Profile of a Creative Person.

IN RELATION TO OTHERS:

Not a joiner—Few close friends—Independent—Dominant—Assertive, bold, Courageous—Little interest in interpersonal relations—Independence from parents—Independence of judgment, especially under pressure—Conventional morality

IN JOB ATTITUDES:

Preference for things and ideas to people—High regard for intellectual interests—Less emphasis on and value in job security—Less enjoyment in and satisfaction from detail work and routine—High level of resourcefulness and adaptability—Skeptical—Precise, critical—Honesty, integrity—Ability to toy with elements—Capacity to be puzzled—High tolerance from ambiguity—Persistence—Emphasis on theoretical values

ATTITUDES TOWARD SELF:

Introspective, egocentric, internally preoccupied—Openness to experiences—Less in need to protect self—Inner maturity—Great ego strength, strength of character—Highly responsive emotionally—Less emotionally stable—Less self acceptance

OTHER CHARACTERISTICS:

Spontaneity, enthusiasm—Stubbornness—Originality—Adventurous—High Excitability and irritability—Compulsive—Complex as a person—Anxious.

We have seen exceptions to some of these characteristics but they do give us a guide to think about.

That's the reason for this article. As it takes both parents and the school to educate a child, knowing what a creative person is like may give us all some guidance in developing the most important resource we have—our gifted, creative youngsters!

MARCH 1974

SUNDAY	MONDAY	TUESDAY	WEDNESDAY	THURSDAY	FRIDAY	SATURDAY
<p>One morning, after sleeping poorly, I woke with a start and witnessed, as from a seat in a theatre, three acts which brought to life an epoch and characters about which I had no documentary information and which I regarded moreover as forbidding. Long after, I succeeded in writing the play. — Jean Cocteau</p>					1	2
3	4	5	6 PTA Ex. Bd. Mtg., Forest 8:30 P.M. & Shaw, 1:00 P.M.	7 "Lights On For Education," Memorial J.H.S. PTA Ex. Bd. Mtg., Clear Stream, 9:30 A.M.	8 PURIM	9
10	11 Pre-School Mtg., Shaw & Washington, 3:00 P.M.	12 C.H.S. Bd. of Ed. Mtg., 8:00 p.m.	13	14	15 Father-Son-Daughter Night, Clear Stream, 7:30 P.M.	16
17	18 Family Living, 5th & 6th Gr. Parents, Forest, 8:00 P.M.	19	20 Pre-School Mtg., Forest, 2:00 P.M. PTA Gen. Mtg., Forest, 8:30 P.M.	21 Family Living, Forest, 8:00 P.M. PTA Gen. Mtg., Clear Stream, 8:00 P.M. PTA Fashion Show, Shaw	22	23
24	25 Sex Hyg. Film for 5th & 6th Gr. Boys & Girls & Parents, Clear Stream	26 Dist. #30 Bd. of Ed. Mtg., 8:15 P.M. Sex Hyg. Mtg., 6th Gr., Clear Stream	27 Sex Hyg. Mtg., 5th Gr., Clear Stream, 8:00 P.M.	28 Family Living 6th Gr. Pupils and Parents. 8 P.M.	29 District Music Concert, Shaw, 8:15 P.M.	30
31						

THE TEACHING OF RESPONSIBILITY

If we are trying to effect "a school without failure,"* then one of the most important tasks is the teaching of responsibility. Ordinarily children learn by means of a loving relationship with responsible parents, an involvement which implies parental example and parental teaching. Through the proper combination of love and discipline the responsible parent creates the necessary involvement with his child and teaches him responsibility. Children, who are not exposed early in their lives to others who care about them enough to love and discipline them, may never learn to be responsible. For that failure they may suffer interminably.

Responsibility can be learned at any age. Never-the-less, it is easier to learn correctly at first than to overcome bad learning. Learning how to study in college is more difficult than learning in elementary or high school.

Many parents will agree—that children do not learn responsibility easily. Children do not know that what seems so simple to them will not fulfill their needs, so almost from infancy they rebel against reality that they must learn from their parents how to fulfill their needs. Later, when they are old enough to recognize reality, they test their parents with irresponsible behavior. Through discipline, tempered with love, parents are teaching their children to behave better. The child knows that the parent cares.

Children want to become responsible, but they won't accept discipline and learn better ways unless they feel the parents care enough to show them actually the responsible way to behave.

A common example is the child who wants to play with his friends or watch television even though he has not done his homework. He promises, threatens, begs and cajoles his parents in an effort to evade his responsibility. He sometimes gets his way, but has he learned about reality? Confronted in school with his homework not completed, he will often blame his parents and not himself, thus further compounding his own irresponsibility. Later when he is faced with a difficult situa-

tion, not having learned responsibility, he is unprepared to cope with it. Parents, who are willing to suffer the pain of the child's intense anger by firmly holding him to the responsible course, are teaching him a lesson that will help him his entire life. Parents who do not do so are setting the pattern for further irresponsibility, which prevents the child from fulfilling the need to feel worthwhile—to be a failure.

Parents must not only hold the child to the correct course of action, but also they must show by example that they are also capable of taking the responsible course. Parents cannot successfully discipline a child unless they are self-disciplined. A parent who never reads a book, or who spends a great amount of time in front of the television screen and doesn't demonstrate any of the values of using his intellect, will be hard-pressed to teach his child the value of doing well in school through diligent study. The child who does not learn by instruction and example will not respect his parents. If they continue to fail him, he may cease to love them because, in a sense, they are depriving him of a chance to fulfill his needs. When discipline is reasonable and understandable, and when the parents' own behavior is consistent with their demands on the child, he will love and respect them even though his surface attitude may not always show it. Parents must understand that taking the responsible course will never permanently alienate the child.

Children learn responsibility through involvements with fellow human beings, preferably loving parents and teachers, who will love and discipline them properly; who are intelligent enough to allow them the freedom to try out their newly acquired responsibility as soon as they show readiness to do so.

HELEN FINK
Special Counselor
Forest Road School

*Glasser, William, M.D., *Schools Without Failure*, Harper & Row, New York, 1969.

APRIL 1974

SUNDAY	MONDAY	TUESDAY	WEDNESDAY	THURSDAY	FRIDAY	SATURDAY
	1 PTA Council Mtg., 8:00 P.M., Shaw Avenue	2 C.H.S. Bd. of Ed. Mtg., 8:00 P.M.	3 PTA Ex. Bd. Mtg., Forest, 8:30 P.M. PTA Gen. Mtg., 8:00 P.M., Shaw	4 PTA Ex. Bd. Mtg., Clear Stream, 9:30 A.M.	5 Cultural Arts Assembly, Shaw	6
7 M SUNDAY	8 Easter Recess SCHOOL CLOSED	9 Easter Recess SCHOOL CLOSED	10 Easter Recess SCHOOL CLOSED	11 Easter Recess HOLY THURSDAY SCHOOL CLOSED	12 Easter Recess GOOD FRIDAY SCHOOL CLOSED	13 SEVENTH DAY OF PASSOVER
14 ER SUNDAY HHTH DAY PASSOVER	15 SCHOOL REOPENS	16	17 PTA Gen. Mtg., Forest, 8:30 P. M.	18 PTA Show Date, Clear Stream	19	20 Vision Screening, Shaw, A.M.
21	22	23 Dist. #30 Bd. of Ed. Mtg., 8:15 P.M.	24	25 Pre-School Mtg., Forest, 3:00 P.M. Sex Hyg. Film for 4th Gr. girls, Clear Stream, 3 P.M. Sex Hyg. Mtg., 6th Gr., Shaw (Boys)	26 Reg. for next Year's Kindergarten, Each school, 9-11 A.M.	27 Reg. for school budget vote, 7 A.M. Noon, Each School Vision Screening, Forest, 9:00 A.M.
28	29	30	<p>The mere formulation of a real problem is far more essential than its solution, which may be merely a matter of mathematical or experimental skill. To raise new questions, new possibilities, to regard old problems from a new angle requires creative imagination and marks real advances in science.</p> <p style="text-align: right;">— Albert Einstein</p>			

SCHOOL POLICIES

SCHOOL HOURS

for grades 1, 2, and 3 are from 9:00 a.m. to 3:00 p.m.
for grades 4, 5, and 6 are from 8:30 a.m. to 2:45 p.m.

LUNCH

Lunch is served beginning with the first day of school. Pupils may go home for lunch, bring lunch from home, or buy the school lunch in the cafeteria for 50c. Monthly menus are provided so that if foods are served which your child does not eat, you can make other provisions for him for those days. In case a child forgets his lunch money or his lunch, or loses either, we have a charge system to cover the emergency. The cashier in the cafeteria keeps the record of such charges and contacts the parents should a charge not be paid in a reasonable time.

ICE CREAM

Ice cream is sold daily to those pupils who wish it. It is not part of the hot lunch and costs an additional 10c.

RECESS MILK

Recess milk is available to all children beginning about the third week of the school year and is sold at a cost of 50c per week payable each Thursday for the following week. You will be notified as to the exact date. Money brought in late (Friday) cannot be accepted. In case of a child's absence, no refund is made for periods of less than a full week.

ABSENCES

When your child has been absent, State law requires that he bring a note from you explaining the absences and the date(s) of absence(s). The note should be presented to the nurse before going to the classroom. Please be specific. Just saying, "he was sick" is not enough. Indicate whether it was "virus," "fever," "cold," etc. A note is required for an absence due to a religious holiday. A note is required for any tardiness, giving the reason. If your child contracts a contagious disease, such as mumps, measles, etc., please phone the school nurse so that she can alert the parents in your child's class that their children have been exposed. Be sure to keep the emergency card up to date so that we will know whom to call should your child become ill and have to go home.

NOON HOUR RULES

When pupils misbehave in the cafeteria, auditorium, or on the playground during the noon hour, after repeated reminders, the teachers have the authority to exclude them from staying in school for lunch for a few days, or longer, depending on the misbehavior. If you receive such a note from us, we would appreciate your cooperation. Whether or not a mother is home during the noon hour has no bearing on this exclusion.

RELEASED TIME FOR RELIGIOUS INSTRUCTION

A Release Form signed by the parent is necessary should you want your child excused from school for religious instruction. Such forms can be obtained from your church. The time provided is the last hour of school on Wednesday afternoons.

EXITS AND ENTRANCES

Your child's class is assigned a specific exit and entrance to use. You will thus know where to meet him if you come to pick him up. Parents picking up children are asked to meet them at the exit, not the classroom.

ENTRANCE TIMES

Morning — All Schools	Noontime — Shaw & Forest
Grades 1, 2, & 3 — 8:50	Grades 1, 2, & 3 — 12:50
Grades 4, 5, & 6 — 8:20	Grades 4, 5, & 6 — 12:20
Noontime — Clear Stream: Grades 5 & 6 — 12:05	
Grades 3 & 4 — 12:35; Grades 1 & 2 — 1:05	

Because there is no supervision of the playground in the morning, we suggest you arrange your child's departure from home to allow him to arrive just in time to enter the building during the proper interval. In inclement weather he may come into the designated area five minutes before the above times.

CLASS INTERRUPTIONS

No unnecessary interruptions of classes are allowed once the day's sessions have begun. When your child forgets a book, homework, sneakers, lunch money, etc., please bring these to the office. All pupils are instructed to check with the office at lunch time for such forgotten items. In the interest of the child's all-round education, we urge you not to make a practice of bringing forgotten items to school. The child should be developing his own sense of responsibility for these things.

MAY 1974

SUNDAY	MONDAY	TUESDAY	WEDNESDAY	THURSDAY	FRIDAY	SATURDAY
			1 PTA Ex. Bd. Mtgs., Clear Stream, 9:30 A.M. & Forest, 8:30 P.M.	2 Reg. for school budget vote, 4-10 P.M., Each School PTA Ex. Bd. Mtg., Shaw, 1:00 P.M.	3	4
	5 Art Ex., Forest, 7:30 to 9:00 P.M. Sex Hyg. Mtg., 5th & 6th Gr. Mothers, Shaw, 1:00 P.M.	6	7	8 Voting on School Budget, 7 A.M. to 10:00 P.M., all schools Teach. Rec. Day Lunch, Forest & Clear Stream Sex Hyg. Mtg., 5th Gr. girls, Shaw, 3:00 P.M.	9	10 Lag B'omer Sex Hyg. Mtg., 6th Gr. girls, Shaw, 3:00 P.M.
11	12	13 Family Living Mtg., Parents of 4th Gr. girls, Forest, 8:00 P.M.	14	15 PTA Gen. Mtg., Installation, Forest, 8:30 P.M.	16 Family Living Mtg., 4th Gr. girls, Forest, 2:45 P.M. PTA Gen. Mtg., Clear Stream, 8:00 P.M.	17
18	19	20	21 Art Exhibit, Clear Stream, 7:30 to 9:00 P.M. Cake Sale, Clear Stream, 7:30 P.M.	22	23 Art Exhibit, Shaw, 7:30 to 9:00 P.M.	24
25	26	27 MEMORIAL DAY SCHOOL CLOSED SHAWOITH	28	29 PTA Gen. Mtg., Installation, Shaw, 8:00 P.M.	30	31

SCHOOL POLICIES

GYM SUITS AND SNEAKERS

Gym suits are required of pupils below the 3rd grade, but sneakers are necessary for any pupils using the gym. Boys and girls from the 3rd through 6th grades are required to wear gym suits and sneakers on the assigned gym days. The gym teachers will explain this to the pupils, but many times they do not bring correct information home.

Boys who MUST PURCHASE A NEW SUIT should buy the one-piece ROYAL BLUE, bloomer type, with elastic bottoms, or ROYAL BLUE shorts with elastic insert in the cuff, and a white t-shirt. Boys should wear ROYAL BLUE shorts, with elastic top, sneakers (high top ones preferred), and white or SCHOOL "T" sneakers.

IF A CHILD HAS ANOTHER COLOR, OR TYPE, HE DOES NOT HAVE TO BUY A NEW ONE. The above apparel may be purchased at many local stores in Valley Stream. NO ONE IS ALLOWED ON THE GYM FLOOR WITHOUT SNEAKERS.

APPOINTMENTS WITH TEACHERS

In order that pupils' classtime be used to the fullest advantage, we request that parents do not seek conferences with teachers during school hours. If you wish a conference, please make an appointment to see the teacher after school. Teachers are available for such conferences every day except Wednesdays and Fridays.

BICYCLES

Bicycles are allowed at either Forest Road or Clear Stream Avenue Schools because no child lives far enough from the school to make them necessary. They are allowed at Shaw, but are restricted to pupils in grades 4, 5, and 6 who live NORTH OF FORESTER AVENUE. Bicycles used to come to the Shaw Avenue School will be assigned a number. All must have a lock and chain for safety purposes.

GIFTS TO TEACHERS PROHIBITED

The policy of the school district which became effective January 1956, is to prohibit the acceptance of gifts by faculty members on school premises, and to prohibit the solicitation of funds for personal gifts purposes, by any person, or person on the premises.

IN-DAY PROGRAM

In inclement weather, there is an in-day program of motion pictures provided for those pupils who eat in the cafeteria. Pupils who go home to lunch are not allowed to participate in this program because of space limitations, so we ask parents to return these pupils to school on such days just in time for the afternoon session—not before 12:50 p.m. for grades 1 to 3, and 12:20 p.m. for grades 4 to 6 at Shaw and Forest; and not before 12:05 for grades 5 and 6, 12:35 for grades 3 and 4, and 1:05 for grades 1 and 2 at Clear Stream.

HOMEWORK REQUIREMENTS

Homework is required of all pupils, but it will vary from day to day. First and second grade pupils may have fifteen to twenty minutes of homework per day, while third and fourth grade pupils are likely to have thirty to forty minutes. Fifth and sixth graders are expected to devote as much as an hour to homework, but again this may not be every day—it will depend on the pupil and his needs.

LOST AND FOUND

Unmarked articles lost by pupils are placed in the Lost-and-Found, which is in the Nurse's Office at Shaw & Forest, and the custodian's office at Clear Stream. Such articles, if not claimed at the end of the school year, are given to a charitable organization. However, any article bearing a child's name is returned directly to him. Please place your child's name on all his belongings.

STAYING AFTER SCHOOL

To eliminate any confusion or problems, the school may have your child every day for an additional half hour. During this half hour beyond the regular school day, the teacher may schedule your child for special help or keep him for any of several reasons. We ask that you keep this in mind and not schedule dental appointments, dancing lessons, etc. until after that interval. Teachers are also available to parents during the half hour after school, except on Wednesday and Friday, for conferences.

ASSEMBLIES

When your child's class puts on the assembly, we welcome your attendance, but we do ask you not to bring pre-school children. As much as we realize that it is a thrill for a child to see a big brother perform, they are often distracting to a child concerned. Picture taking is not allowed without prior approval.

JUNE 1974

SUNDAY	MONDAY	TUESDAY	WEDNESDAY	THURSDAY	FRIDAY	SATURDAY
						1
	2 PTA Council Mtg., 8:00 P.M., South H.S. String Recital, Shaw, 7:30 P.M.	3	4 String Recital, Forest, 7:30 P.M.	5 PTA Joint Ex. Bd. Mtg. Shaw, 1:00 P.M. String Recital, Clear Stream, 7:30 P.M. PTA Joint Ex. Bd. Mtg., Forest, 8:30 P.M.	6 PTA Joint Ex. Bd. Mtg., Clear Stream, 8:00 P.M.	7
		8				9
		10	11 C.H.S. Bd. of Ed. Mtg., 8:00 P.M.	12	13	14
		15				16
17 MOTHER'S DAY	18	19	20 Closing Exercise for 6th Grade	21	22 LAST DAY OF SCHOOL	23
24	25	26	27	28	29	30
31 Annual School Census Begins	32	33 Dist. #30 Bd. of Ed. Mtg., 8:15 P.M.				

seemed that I had inside me, swelling and gathering all the time, a huge black cloud and that this cloud was laden with electricity, pregnant crested, with a kind of hurricane violence that could not be held in check much longer, that the moment was approaching fast when it must break. Well all I can say is that the storm did break. It came in a torrent, and it is not over yet. — Thomas Wolfe

SHAW AND WASHINGTON AVENUE SCHOOLS

CLASS MOTHER LIST

Class Mother Chairman Elaine Kelly, 825-0113

Room	Class Mother	Tel. Number	Teacher
Kindergarten Representative Carmela D'Auria, 285-4808			
01 AM	Mrs. Audino	285-6212	Miss Stelzer
01 AM	Mrs. Chmurzynski	285-7209	Miss Blessinger
01 PM	Mrs. Musto	872-3247	Miss Blessinger
02 PM	Mrs. Giacalone	825-3854	Miss Starler
Grade Representative Susan Jacobs, 872-3144			
02	Mrs. Mac Ginley	285-8719	Mrs. Hartman
03	Mrs. Nolan	285-5525	Mrs. Lazar
03	Mrs. Unger	825-8162	Mrs. Levine
05	Mrs. Jacobs	872-3144	Mrs. Barra
Grade Representative Ginny Kropas, 872-8117			
26	Mrs. Layden	285-7624	Miss Shapiro
28	Mrs. Piemonte	825-8032	Mrs. Okpych
30	Mrs. Manzo	872-8717	Miss Cohen
33	Mrs. Donnelly	561-8382	Mrs. Williams
35	Mrs. Panarelli	825-7773	Miss Laraway
Grade Representative Lonnie Di Luccio, LO 1-6837			
04	Mrs. Nugent	872-6378	Mrs. Sweet
06	Mrs. Lynch	872-3887	Mrs. D. Stein
07	Mrs. Di Nonno	561-1785	Mrs. Strumpf
32	Mrs. Schlaeger	285-7588	Mrs. Stevens

Gr.	Room	Class Mother	Tel. Number	Teacher
4th Grade Representative Anita Filosa, LO 1-0074				
4	108	Mrs. Ging	CU 5-6072	Mrs. Bratt
4	109	Mrs. Duffe	LO 1-9291	Mrs. Benedetto
4	110	Mrs. Filosa	561-0074	Mr. Riccobono
4	114	Mrs. Hadjiyane	CU 5-7434	Mrs. Stiefel
5th Grade Representative Cathy Rosenbaum, 285-5059				
5	116	Mrs. Audino	285-6212	Mrs. Hearn
5	118	Mrs. Rosenbaum	285-5059	Mrs. Hamcke
5	121	Mrs. Rositano	872-3489	Mrs. Seid
5	122	Mrs. Zeiner	285-9898	Mr. Beyer
6th Grade Representative Lee Short, 285-5019				
6	123	Mrs. Magnus	825-8038	Miss Lanell
6	124	Mrs. Paone	285-7029	Mrs. Sherman
6	125	Mrs. Short	825-5019	Miss Visentin
6	127	Mrs. Kelly	285-5252	Mr. Giacalone
Special				
CL	131	Mrs. Feilke	CU 5-5157	Mrs. Lewis

JULY 1974

SUNDAY	MONDAY	TUESDAY	WEDNESDAY	THURSDAY	FRIDAY	SATURDAY
	1	2	3	4 INDEPENDENCE DAY	5	6
7	8	9 C.H.S. Bd. of Ed. Mtg., 8:00 P.M.	10	11	12	13
14	15	16	17	18	19	20
21	22	23 Dist. #30 Bd. of Ed. Mtg., 8:15 P.M. (Tentative)	24	25	26	27
28	29	30	31	The creative personality is unique in that in the initial stages he prefers the chaotic and disorderly and tends to reject what has already been systematized. <i>Polsh I. Hallman</i>		

CLEAR STREAM AVENUE SCHOOL

CLASS MOTHER LIST

Grade	Room	Class Mother	Tel. Number	Teacher
Kindergarten Representative Ann Prisco, 285-5744				
K9	9:00 a.m.	Kathy Cerrito	872-9079	Miss Eden
K9	9:00 a.m.	Rosemary Smith	561-8667	Miss Pden
K9	9:00 a.m.	Kathleen Pesce	285-5178	Miss Eden
K9	9:00 a.m.	Madelaine Weiss	825-1719	Miss Eden
K9	12:30 p.m.	Jan Pessa	285-6044	Miss Eden
K9	12:30 p.m.	Jean Sivillo	825-6003	Miss Eden
K9	12:30 p.m.	Fran Ciniglio	285-7996	Miss Eden
K9	12:30 p.m.	Margie Eichler	872-8113	Miss Eden
K8	12:30 p.m.	Ruth Settepani	285-5725	Miss Starler
K8	12:30 p.m.	Roseann Petruzillo	285-4795	Miss Starler
K8	12:30 p.m.	Lynn Valenti	872-8574	Miss Starler
K8	12:30 p.m.	Sally Prezotte	825-9597	Miss Starler
1st Grade Representative Eileen Calandrino, 825-6778				
1	A	JoAnn Esposito	285-6815	Miss Patterson
1	A	Kay McDonald	825-3313	Miss Patterson
1	A	Joan Bauer	285-5049	Miss Patterson
1	A	Eileen Calandrino	825-6778	Miss Patterson
1	B	Sue Farrell	872-8026	Mrs. Schaaf
1	B	Sheryl Holton	561-9055	Mrs. Schaaf
1	B	Stella Rusinyak	285-8094	Mrs. Schaaf
1	B	Lenore Vita	285-5394	Mrs. Schaaf
1	7	Bernice Castello	561-0241	Mrs. Lauria
1	7	Nancy Daly	285-4836	Mrs. Lauria
1	7	Millie DiBiase	285-0026	Mrs. Lauria
1	7	Sheila Bell	825-8972	Mrs. Lauria
2nd Grade Representative Rose McMeekin, 285-4925				
2	5	Jeanne Blohm	285-8892	Mrs. Galati
2	5	Anne Ciaramella	285-5072	Mrs. Galati
2	5	Fran Gleason	285-9067	Mrs. Galati
2	5	Rose McMeekin	285-4925	Mrs. Galati
2	6	Marie Cusumano	VA 5-4956	Mrs. Guberman
2	6	Pat Lynch	825-5958	Mrs. Guberman
2	6	Stella Rusinyak	285-8094	Mrs. Guberman
2	6	Irene Uzzi	825-9221	Mrs. Guberman
3rd Grade Representative Beverly Jablonowski, 325-2489				
3	1	Marion Acquavella	825-2272	Miss Firpo
3	1	Lynne Boyle	825-7509	Miss Firpo
3	1	Maureen Casey	285-9571	Miss Firpo
3	1	JoAnn Esposito	285-6815	Miss Firpo
3	2	Barbara Bevacqua	872-3504	Miss Schindelmann
3	2	Beverly Jablonowski	825-2489	Miss Schindelmann
3	2	Marie Pascuzzi	825-8401	Miss Schindelmann
3	2	Regina Schneider	872-8409	Miss Schindelmann
3	3	Blanche Bartsch	LO 1-6034	Mrs. Quinn
3	3	Phyllis Capitano	872-8313	Mrs. Quinn
3	3	JoAnn La Barbera	285-9820	Mrs. Quinn
3	3	Marilyn Palazzo	872-3372	Mrs. Quinn
4th Grade Representative Jean Savarese, 285-5116				
4	3	Eleana Cirenza	285-5671	Miss Inwald
4	3	Shirley Fifield	285-9081	Miss Inwald
4	3	Rose Ann Potter	872-9337	Miss Inwald
4	3	Jean Savarese	285-5116	Miss Inwald
4	23	Fran Carnivale	872-0493	Mrs. Galbraith
4	23	Nettie Ghiradella	561-6450	Mrs. Galbraith
4	23	Julie Sagginario	285-8670	Mrs. Galbraith
4	23	Jennie Tretola	872-9527	Mrs. Galbraith
5th Grade Representative Mary Tragnor, 285-9502				
5	25	Eleanor Schreiner	CU 5-9124	Mr. Camilleri
5	25	Barbara Bevaqua	872-3504	Mr. Camilleri
5	25	Gertrude Barewald	872-3253	Mr. Camilleri
5	25	Dolores O'Leary	VA 5-5943	Mr. Camilleri
5	27	Gloria Corradi	CU 5-5255	Miss Yelland
5	27	Beverly Jablonowski	285-2489	Miss Yelland
5	27	Regina Schneider	872-9409	Miss Yelland

5	27	Connie Deering	CU 5-6210	Miss Yelland
5	28	Mary Tragnor	285-9502	Mrs. Gerdyk
5	28	Lois Barry	CU 5-3654	Mrs. Gerdyk
5	28	Rose Bochichio	285-4868	Mrs. Gerdyk
5	28	Merrily Spagnola	872-6327	Mrs. Gerdyk
6th Grade Representative Mary Ammann, CU 5-6090				
6	21	Mary Ann Boody	561-0029	Mr. Cooper
6	21	Elaine Dysart	285-5716	Mr. Cooper
6	21	Betsy Mulato	CU 5-6048	Mr. Cooper
6	22	Kay Schmidt	872-8692	Mr. Cooper
6	22	Marie Grande	LO 1-1848	Miss Melzer
6	22	Barbara McLaughlin	VA 5-6162	Miss Melzer
6	22	Ann Prisco	CU 5-5744	Miss Melzer
6	24	Terry Annaruma	285-9336	Mrs. Wiesen
6	24	Fay Birbiglia	CU 5-9439	Mrs. Wiesen
6	24	Lynne Boyle	825-7509	Mrs. Wiesen
6	24	Carol Schmidt	825-3701	Mrs. Wiesen

FOREST ROAD SCHOOL

CLASS MOTHER LIST

Class Mother Chairmen

Irena Danels, 791-1506 and Marie Briody, 791-5817

Grade	Room	Class Mother	Tel. Number	Teacher
K	AM 201	Sandy Train	791-8221	Mrs. Murray
K	AM 201	Linda Zahn	791-4516	Mrs. Murray
*K	AM 201	Evelyn Grabois	791-1604	Mrs. Murray
K	PM 201	Linda Maerhofer	791-7327	Mrs. Murray
K	PM 201	Sylvia Markowitz	791-1257	Mrs. Murray
1	203	Sophie Gottlieb	791-6639	Miss Caffo
1	203	Pam Goldman	791-1128	Miss Caffo
1	204	Bea Spector	791-5216	Mrs. Kalhofer
*1	204	Paulette Kirschenbaum	791-7045	Mrs. Kalhofer
1	204	Carol Provanzano	825-5915	Mrs. Kalhofer
2	205	Beth Greenwald	791-7509	Miss Perrich
*2	205	Elaine Sandler	791-5765	Miss Perrich
2	205	Betty Fine	791-1806	Miss Perrich
2	206	Barbara Smerling	791-2540	Miss Post
2	206	Marcia Balaban	791-7598	Miss Post
*3	207	Judy Orloff	791-3820	Mrs. Cummings
3	207	Marion Lowenbraun	791-3980	Mrs. Cummings
3	207	Ruth Bazil	791-8556	Mrs. Cummings
3	209	Kathy McClellan	872-9794	Miss Clarke
3	209	Jean Stone	791-7182	Miss Clarke
3	209	Audrey Chason	791-8248	Miss Clarke
*4	210	Renee Pepper	791-3857	Mrs. Cabral
4	210	Marilyn Fogel	791-4701	Mrs. Cabral
4	210	Andrea Port	791-1353	Mrs. Cabral
4	211	Mrs. Langbart	791-8442	Miss Nancken
4	211	Abby Tedesco	791-2157	Miss Nancken
5	215	Joyce Sprung	791-9122	Mrs. Kessler
5	215	Shelly Koval	791-1232	Mrs. Kessler
5	218	Claire Gendelman	791-5811	Mrs. Neuman
5	218	Pat Block	791-4920	Mrs. Neuman
*5	218	Irene Bochner	791-6351	Mrs. Neuman
5	218	Marie Briody	791-5817	Mrs. Neuman
6	217	Anita Suriani	791-3980	Mrs. Melnick
6	217	Irena Danels	791-1506	Mrs. Melnick
*6	217	Doris Bernanke	791-3790	Mrs. Melnick
6	217	Ruth Clayman	791-3934	Mrs. Melnick
6	220	Rhoda Blaustein	791-6475	Mr. Kaufman
6	220	Diane Kahn	791-4756	Mr. Kaufman
6	220	Lydia Rosen	791-5488	Mr. Kaufman
6	220	Anna Hirschowitz	791-1877	Mr. Kaufman

*Grade Coordinator

AUGUST 1974

SUNDAY	MONDAY	TUESDAY	WEDNESDAY	THURSDAY	FRIDAY	SATURDAY
				1	2	3
4	5	6	7	8	9	10
11	12	13 C.H.S. Bd. of Ed. Mtg., 8:00 p.m.	14	15	16	17
18	19	20	21	22	23	24
25	26	27 Dist. No. 30 Bd. of Ed. Mta., 8:15 p.m.	28	29	30	31

**UNION FREE SCHOOL DISTRICT No. 30 AND
CENTRAL HIGH SCHOOL DISTRICT No. 1,
VALLEY STREAM, NEW YORK**

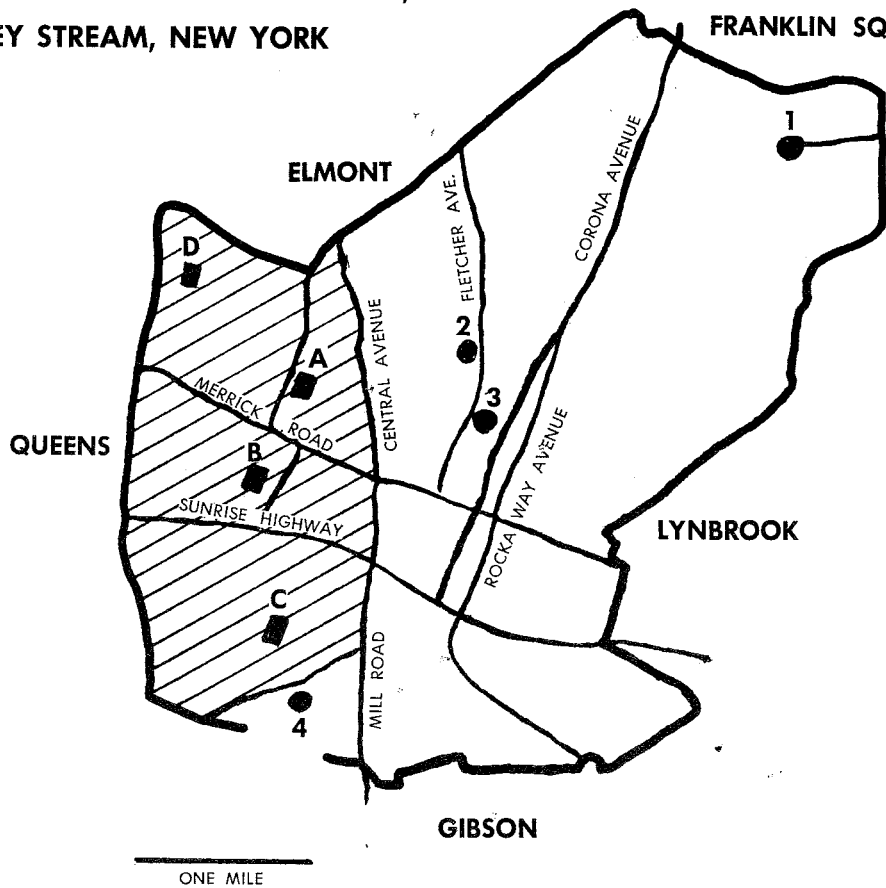

DISTRICT No. 30 SCHOOLS

- Shaw Avenue A
- Clear Stream Avenue B
- Forest Road C
- Washington Avenue D

Shaded Area — District 30

HIGH SCHOOLS

- North High 1
- Memorial Junior 2
- Central High 3
- South High 4

SCHOOL TELEPHONE DIRECTORY

IN OFFICE: SHAW AVENUE SCHOOL

Principal VA 5-9131

Business Office VA 5-9131

Administrative Manager VA 5-9131

Clear Stream Avenue School

Principal's Office VA 5-3044

Business Office VA 5-3044

Forest Road School

Principal's Office PY 1-7676

Business Office PY 1-7676

Shaw Avenue School

Principal's Office VA 5-9131

Nurse's Office VA 5-9131

Washington Avenue School

Office VA 5-9131

Special Services

Administrative Assistant/Curriculum VA 5-9131

Psychologist VA 5-9131

Speech Consultant VA 5-9131

Reading Consultant PY 1-7676

Audio-Visual Consultant LO 1-1165

INDEX

- Board of Education and School Calendar see October
- Administration and Special Services see November
- Clear Stream PTA see December
- Shaw and Washington Avenue PTA see January
- Forest Road PTA see February
- Everyone is Creative in Some Way see March
- The Teaching of Responsibility see April
- School Policies see May & June
- Shaw and Washington Class Mothers see July
- Clear Stream and Forest Class Mothers see August
- Map of the District see facing page

CENTRAL HIGH SCHOOL DISTRICT NO. 1
Telephone Number: VA 5-8642

Use this number for all high school buildings, offices and personnel

NOTES

UNION FREE SCHOOL DISTRICT THIRTY
VALLEY STREAM, NEW YORK

30

SCHOOL ACTIVITIES

Calendar

FOR 1973-1974

PUBLISHED BY THE BOARD OF EDUCATION

AND PARENT-TEACHER ASSOCIATIONS

VALLEY STREAM UNION FREE SCHOOL
DISTRICT THIRTY

30

SCHOOL ACTIVITIES

Calendar

FOR 1974-1975

PUBLISHED BY THE BOARD OF EDUCATION
AND PARENT-TEACHER ASSOCIATIONS

TELEPHONE DIRECTORY

INDEX

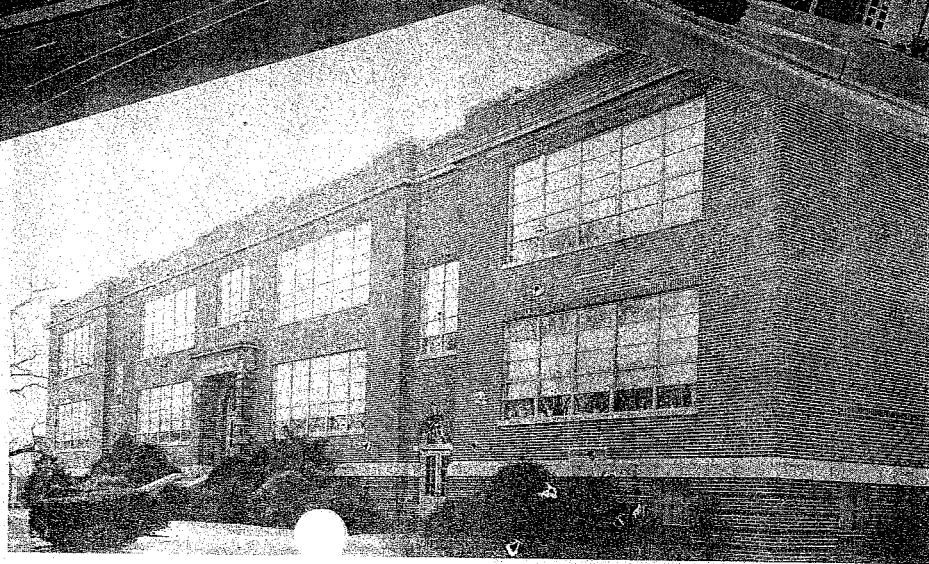

SEPTEMBER 1974

SUNDAY	MONDAY	TUESDAY	WEDNESDAY	THURSDAY	FRIDAY	SATURDAY
1	2 LABOR DAY	3 Faculty Meeting	4 SCHOOL OPENS PTA Book Cover Sale, Clear Stream, 2:45 P.M.	5 PTA Exec. Bd. Mtg., Clear Stream, 9:30 A.M. Book Cover Sale, Clear Stream, 2:45 P.M.	6	7
8	9	10 PTA Bowling Starts, Forest Road, 12:30 P.M. C.H.S. Bd. of Ed. Mtg., 8:00 P.M.	11 "Meet the Teacher Night", Forest, 8:30 P.M.	12 Parents' Night, Shaw, 8:15 P.M. (Grades 4-6)	13	14
15	16	17 ROSH HASHANAH SCHOOL CLOSED	18 ROSH HASHANAH SCHOOL CLOSED	19 Parents' Night, Shaw, 8:15 P.M. (Grades K-3) PTA Gen. Mtg., Clear Stream, 8:00 P.M.	20	21
22	23	24 Dist. #30 Bd. of Ed. Mtg., 8:15 P.M. Parents' Night, Washington, 8:15 P.M.	25 PTA Exec. Bd. Mtg., Shaw, 1:00 P.M.	26 YOM KIPPUR SCHOOL CLOSED	27	28
29	30	Sometimes a neighbor whom we have disliked a lifetime for his arrogance and conceit lets fall a single commonplace remark that shows us another side, another man, really; a man un-				

SCHOOL ADMINISTRATION

Dr. William T. Callahan, *District Superintendent*

Sherwood S. Quick
District Principal

SCHOOL PRINCIPALS

CLEAR STREAM AVENUE SCHOOL
Richard M. Burbell

FOREST ROAD SCHOOL
Maurice E. St. Mary

SHAW AVENUE SCHOOL
Lawrence Cid

William J. Van Ness, *Administrative Assistant/Curriculum*
George W. Niederhauser, *Administrative Assistant/Business*

SCHOOL SECRETARIES

Jeanne Feeney, *Clear Stream Avenue*
Mary McDowell, *Forest Road*
Anna Docar, *Shaw Avenue*

DISTRICT SECRETARIAL STAFF

Margaret Bradley
Innie O'Connell
Tella Schlaeger

Lucy Felice
Gloria Zweier

Mary Ribando
Jean Annona
Edythe Sanchez

Evelyn Pearn, *Cafeteria Manager*

DISTRICT SPECIALISTS AND SPECIAL TEACHERS

Frank DeMarco, *Director of Educational Communications*
Rosalyn Kessler, *Psychologist*
Estelle Friedman, *Psychologist*
Raydine Teicheira, *Speech Consultant*
Robin Hananel, *Speech Teacher*
Susan Wasserman, *Foreign Language Consultant*
Henry Kohlmann, *Instrumental Music Teacher*
Barbara Epstein, *Instrumental Music Teacher*

OTHER SPECIALISTS AND SPECIAL TEACHERS

Clear Stream Avenue School

Cathleen Danowski, *Special Counselor*
Janet Poppe, *Reading Specialist*
Grace Giacobone, *Art*
Philip Hessemer, *Physical Education*
Joan Henningsen, *Physical Education*
Linda Pratt, *Music*
Anita Strelisker, *Library Media Specialist*
Edna Giebel, *Nurse-Teacher*

Forest Road School

Helen Fink, *Special Counselor*
Ada Keane, *Reading Consultant*
Eileen Goldsmith, *Art*
Alfred Stevens, *Physical Education*
Joan Henningsen, *Physical Education*
Diane Kislin, *Music*
Rose Agree, *Library Media Specialist*
Hilda Rosenfeld, *Nurse-Teacher*

Shaw Avenue School

Noel Giambalvo, *Special Counselor*
Florence Galbraith, *Reading Teacher*
Rosemary Williams, *Reading Teacher*
Linda Muckle, *Art*
Anita Zetlin, *Art*
Thomas Rouse, *Physical Education*
Joan Stein, *Physical Education*
Kathryn Egan, *Music*
Barbara Briker, *Music*
Sylvia Berkowitz, *Library Media Specialist*
Dorothy McCutchan, *Nurse-Teacher*

NOVEMBER 1974

SUNDAY	MONDAY	TUESDAY	WEDNESDAY	THURSDAY	FRIDAY	SATURDAY
The art of living does not consist in preserving and clinging to a particular mood of happiness, but in allowing happiness to change its form without being disappointed by the change; or happiness, like a child, must be allowed to grow up. — Charles Langbridge Morgan					1	2
3	4	5 ELECTION DAY SCHOOL OPEN	6 PTA Exec. Bd. Mtg., Forest, 9:45 A.M.	7 PTA Exec. Bd. Mtg., Clear Stream, 9:30 A.M. Parent-Faculty Sport Night, Clear Stream, 7:30 P.M.	8	9 PTA Movie, Shaw, 12:00 Noon
10	11 VETERANS' DAY SCHOOL CLOSED	12 C.H.S. Bd. of Ed. Mtg., 8:00 P.M.	13 Pre-School Mtg., Forest 3:00 P.M.	14 PTA Gen. Mtg., Clear Stream, 8:00 P.M.	15	16
17 Pre-School Mtg., Shaw & Washington, 3:00 P.M.	18	19	20 PTA Exec. Bd. Mtg., Shaw, 1:00 P.M.	21	22 PTA Fashion Show, Clear Stream	23
24	25	26 Dist. #30 Bd. of Ed. Mtg., 8-15 P.M.	27 SCHOOL CLOSING AT NOON	28 THANKSGIVING DAY SCHOOL CLOSED	29 SCHOOL CLOSED	30

CLEAR STREAM AVENUE PARENT TEACHER ASSOCIATION

ELECTED OFFICERS 1974-1975

Co-President	Dorothy A. Walz	825-8011
Co-President	Terry Keller	285-7016
First Vice President	Irene Wood	872-8627
Second Vice President	Sheryl Holton	561-9055
Treasurer	Connie Deering	285-6210
Membership	Sandy Henry	825-6572
	Stephanie Klein	825-0151
Recording Secretary	Sue Farrell	872-8026
Corresponding Secretary	Kay MacDonald	825-3313
Delegates to Council	Linda Pratt	Faculty
	Rose McMeekin	285-4925
Past Presidents	Barbara McLaughlin	825-6162
	Margaret Carlson	285-8857
	Marilyn Margolies	285-9465

COMMITTEE CHAIRMEN

Arts and Flyers	Gloria Corradi	285-5255
Typing	Rita Angerthal	872-8252
Audio-Visual	Frank DeMarco	Faculty
Budget	Lenore Vita	285-5394
Cultural Arts	Louise LeJeune Quinn	Faculty
	Ann Docar	285-8914
Health	Edna Giebel	Faculty
Human Relations	Arlene Ercole	285-8127
Juvenile Protection	Barbara McLaughlin	825-6162
Historian	Jennie Tretola	872-9527
Legislation	Marie LiRosi	285-8020
	Rose Ann Potter	872-9337
Mimeographers	Terry Annaruma	285-7598
School & Community	Dominiek DeCandia	825-7242
Pre-School	Cheryl Holton	561-9055
	Stephanie Klein	825-0151
Sunshine	Ann Prisco	235-5744
THE STREAMER—Editor	Dorothy Fusco	285-5526
Distribution	Terry Annaruma	285-7598
Ways & Means		
Fashion Show	Terry Keller	235-7016
	Dorothy Walz	825-8011
Boutique	Connie Deering	825-6210
	Marie Pascuzzi	825-8401
Cake Sales	Kay Ciccone	561-9207
Jelly Apple & Book Covers	Kay Ciccone	561-9207
Bowling	Fran Carnaval	872-0433
	Marie Grande	561-1848
Junior Bowling	Evelyn McGowan	285-4712
	Marie Grande	561-1848
	Evelyn McGowan	285-4712
	Marilyn Tibball	561-9244
Hospitality	Dorothy Walz	825-8011
	Eileen Calandrino	825-6470
	Amelia Pascoello	872-3119
	Ann Guagliardo	325-6879
	Fran Passarelli	872-9429
Publicity	Marie Pascuzzi	825-8401
Publications	Marilyn Palazzo	872-3372
Kindergarten Rep.	Lenore Vita	285-5394
1st Grade Rep.	Ann Prisco	285-5744
2nd Grade Rep.	Eileen Calandrino	825-6470
3rd Grade Rep.	Rose McMeekin	285-4925

4th Grade Rep.
5th Grade Rep.
6th Grade Rep.

Beverly Jablonowski 825-2489
Jean Savarese 285-5116
Mary Tragner 285-9502

P.T.A. PROGRAM

Sept.	4	Book Cover Sale, 2:45 P.M.
	5	PTA Executive Board Meeting, 9:30 A.M.
	5	Book Cover Sale, 2:45 P.M.
	19	PTA General Meeting, 8:00 P.M.
Oct.	1	Primary Parents Night, 8:00 P.M.
	2	Intermediate Parents Night, 8:00 P.M.
	3	PTA Executive Board Meeting, 9:30 A.M.
	15	Human Relations Workshop, 3:00 P.M. (Parent-Child Communication)
	16	Jelly Apple Sale, 2:45 P.M.
	17	Jelly Apple Sale, 2:45 P.M.
Nov.	31	5th & 6th Gr. Halloween Party, 7:30 P.M.
	7	PTA Executive Board Meeting, 9:30 A.M.
	7	Parent-Faculty Sport Night, 7:30 P.M.
	14	PTA General Meeting, 8:00 P.M.
Dec.	22	Fashion Show at St. Theresa Knights of Columbus, 7:00 P.M.
	5	PTA Executive Board Meeting, 9:30 A.M.
	5	Pre-School Meeting, 1:30 P.M. (Parents of 4 year olds)
	12	Holiday Boutique, 2:45 P.M.
	13	Holiday Boutique, 2:45 P.M.
	19	Holiday Assembly, 1:30 P.M.
Jan.	2	PTA Executive Board Meeting, 9:30 A.M.
	16	PTA General Meeting, 3:00 P.M.
	27	Sex Hygiene Film 6th Grade Children, 7:30 P.M.
	28	Sex Hygiene Film 5th Grade Children, 7:30 P.M.
	29	Sex Hygiene Rap Session 5th & 6th, 3:00 P.M.
Feb.	6	PTA Executive Board Meeting, 9:30 A.M.
	6	Cake Sale, 2:45 P.M.
	19	PTA Founders' Day Celebration, 8:30 P.M.
	27	Human Relations Workshop, 3:00 P.M. (Alcoholism in Youth)
Mar.	3	Pre-School Meeting, 1:30 P.M. (Parents & 4 year olds)
	5	PTA Executive Board Meeting, 1:30 P.M.
	7	Father-Son-Daughter Night, 7:30 P.M.
	20	PTA General Meeting, 3:00 P.M.
Apr.	2	PTA Executive Board Meeting, 1:30 P.M.
	5	Vision Screening, 9:00 A.M.
	7	Pre-School Meeting, 1:30 P.M. (Parents of 3 year olds)
	17	Cultural Arts Program, 1:30 P.M.
	23	Teachers' Recognition Day, 11:00 A.M.
	24	Hygiene Film 4th Grade Girls, 3:00 P.M.
May	1	Mothers Day Boutique, 2:45 P.M.
	2	Mothers Day Boutique, 2:45 P.M.
	2	Mother-Daughter Buffet Supper, 7:00 P.M.
	7	PTA Executive Board Meeting, 1:30 P.M.
	15	PTA General Meeting, 7:30 P.M. (Installation & Spring Concert)
	20	Art Exhibit & Cake Sale, 7:30 P.M.
June	4	PTA Joint Executive Board Meeting, 8:00 P.M.
	12	Human Relations Workshop, 3:00 P.M. (Drugs & Youth)

DECEMBER 1974

SUNDAY	MONDAY	TUESDAY	WEDNESDAY	THURSDAY	FRIDAY	SATURDAY
1	2 PTA Council Mtg., 8:00 P.M., Clear Stream	3	4 PTA Exec. Bd. Mtg., Forest, 9:45 A.M.	5 PTA Exec. Bd. Mtg., Clear Stream, 9:30 A.M. Pre-School Mtg., Clear Stream, 1:30 P.M. (Parents of 4 year olds)	6 PTA Holiday Assembly, Shaw	7 PTA Movie, Shaw, 12:00 Noon
8	9 HANUKKAH	10 C.H.S. Bd. of Ed. Mtg., 8:00 P.M.	11 PTA Gen. Mtg., Shaw, 8:15 P.M., Ann Pascale, Handwriting Analyst	12 PTA Holiday Boutique, Shaw & Washington Pre-School Mtg., Forest 2:00 P.M. PTA Holiday Boutique, Clear Stream, 2:45 P.M.	13 PTA Holiday Boutique, Clear Stream, 2:45 P.M. Holiday Chorus Program, Shaw, 1:30 P.M.	14
15	16	17 Dist. #30 Bd. of Ed. Mtg., 8:15 P.M.	18	19 PTA Holiday Assembly, Clear Stream, 1:30 P.M.	20 SCHOOL CLOSURES AT REGULAR TIMES FOR CHRISTMAS VACATION	21
22	23 SCHOOL CLOSED	24 CHRISTMAS EVE SCHOOL CLOSED	25 CHRISTMAS SCHOOL CLOSED	26 SCHOOL CLOSED	27 SCHOOL CLOSED	28
29	30 SCHOOL CLOSED	31 NEW YEAR'S EVE SCHOOL CLOSED	This learned I from the shadow of a tree, That to and fro did sway against a wall, Our shadow selves, our influence, may fall Where we ourselves can never be			

SHAW AND WASHINGTON AVENUES PARENT TEACHER ASSOCIATION

ELECTED OFFICERS 1974-1975

resident	Diane Keenan	285-6068
First Vice President	Marie Casale	825-7872
Second Vice President	Elaine Kelly	825-0113
Recording Secretary	Louise Kiel	285-9651
Corresponding Secretary	Lillian Ging	285-6072
Delegates to Council	Grace Duffe	561-9291
	Miriam Sweet	Faculty
	Ethel Paone	285-7029
	Angela Maglione	825-7440
Financial Secretary	Anita Filosa	561-0074
Past President	Jean Layden	285-7624

COMMITTEE CHAIRMEN

Audio-Visual	Mr. J. Giacalone	Faculty
Budget	Stella Schlaeger	285-7588
Cheer	Lois Patranzino	285-5102
Cultural Arts & Programs	Vera Manzo	872-8717
	Carol Ruggiero	285-8286
Distribution	Diane Keenan	285-6068
Ecology	Sheila Jacobs	285-9052
Grade Rep. Coordinator	Cathy Rosenbaum	285-5059
Historian	Mary Ann Bono	285-6405
Hospitality	Angela Maglione	825-7440
Legislation	Stella Schlaeger	285-7588
Membership	Stella Schlaeger	285-7588
Mimeograph	Ethel Paone	285-7029
Newsletter	Grace Duffe	561-9291
Parent Education	Elaine Kelly	825-0113
Parliamentarian	Jean Layden	285-7624
Pre-School	Peggy Nugent	872-6378
Publicity	Marianne Farella	285-6924
School Board Rep.	Diane Keenan	285-6068
Vision-Screening	Louise Kiel	285-9651
Ways & Means	Marie Casale	825-7872
(Movies, Boutiques, Cup Cake Sale, Sweat Shirt Sale)		
Fashion Show	Elaine Kelly	825-0113
Bowling League, President	Mary Zeiner	225-9898

P.T.A. PROGRAM

Sept.	12	Parents' Night, Shaw (Grades 4-6), 8:15 P.M.
	19	Parents' Night, Shaw (Grades K-3), 8:15 P.M.
	24	Parents' Night, Washington, 8:15 P.M.
	25	PTA Executive Board Meeting, Shaw, 1:00 P.M.
Oct.	8	PTA Sweat Shirt Sale, Shaw & Washington
	11	Cultural Arts Assembly, Shaw
	23	PTA General Meeting (Credda Ross, Astrologer) Shaw, 8:00 P.M.
	26	PTA Ecology Drive (6th graders), 9-12 Noon
Nov.	9	PTA Movie, Shaw, 12:00 Noon
	18	Pre-School Meeting, Shaw & Washington, 3:00 P.M.
	20	PTA Executive Board Meeting, Shaw, 1:00 P.M.
Dec.	6	PTA Holiday Assembly, Shaw
	7	PTA Movie, Shaw, 12:00 Noon
	11	PTA General Meeting, (Ann Pascale, Handwriting Analyst) 8:15 P.M.
	12	PTA Holiday Boutique, Shaw & Washington
Jan.	8	PTA Cup Cake Sale, Shaw & Washington
	15	PTA General Meeting, Shaw, 8:00 P.M.
	20	Pre-School Meeting, Shaw & Washington, 3:00 P.M.
Feb.	7	PTA's Happy Birthday for Shaw (25 years), 8:00 P.M.
	19	PTA Executive Board Meeting, Shaw, 1:00 P.M.
Mar.	6	PTA Fashion Show
	10	Pre-School Meeting, Shaw & Washington, 3:00 P.M.
	15	PTA Ecology Drive (5th graders), 9-12 Noon
	19	PTA Executive Board Meeting, Shaw, 1:00 P.M.
	21	PTA Cultural Arts Assembly, Shaw
Apr.	12	PTA Ecology Drive (School-Clean-Up Day) Shaw, 9-12 Noon
	16	PTA General Meeting, Shaw (Helen Beyer, Oriental Cooking), 8:15 P.M.
	19	Vision Screening, Shaw, A.M.
	24	Sex Hygiene Meeting, Shaw, (6th grade Boys)
May	1	PTA Mother's Day Boutique, Shaw & Washington
	5	Sex Hygiene Meeting, 5th & 6th grade Mothers Shaw, 1:00 P.M.
	7	Sex Hygiene Meeting, 5th grade girls, Shaw, 3:00 P.M.
	9	Sex Hygiene Meeting, 6th grade girls, Shaw, 3:00 P.M.
	15	Teachers' Recognition Day, Shaw
	21	PTA General Meeting, Installation
	24	PTA Ecology Drive (4th graders), Shaw, 9-12 Noon
June	4	PTA Joint Executive Board Meeting, Shaw, 1:00 P.M.
	12	PTA Fathers' Day Boutique, Shaw & Washington

JANUARY 1975

SUNDAY	MONDAY	TUESDAY	WEDNESDAY	THURSDAY	FRIDAY	SATURDAY
			1	2	3	4
			NEW YEAR'S DAY SCHOOL CLOSED	SCHOOL REOPENS PTA Exec. Bd. Mtg., Clear Stream, 9:30 A.M.		
5	6	7	8	9	10	11
			PTA Cup Cake Sale, Shaw & Washington PTA Exec. Bd. Mtg., Forest, 9:45 A.M.			
12	13	14	15	16	17	18
		C.H.S. Bd. of Ed. Mtg., 8:00 P.M.	PTA Gen. Mtg., Shaw, 8:00 P.M. Pre-School Mtg., Forest, 2:00 P.M.	PTA Gen. Mtg., Clear Stream, 3:00 P.M.		
19	20	21	22	23	24	25
	Pre-School Mtg., Shaw & Washington, 3:00 P.M.					
26	27	28	29	30	31	
	Sex Hyg. Film, 6th Grade Children, Clear Stream,	Sex Hyg. Film, 5th Grade Children, Clear Stream, 7:30 P.M. Dist. #30	Sex Hyg. Rap Session, 5th and 6th Grades, Clear Stream,			

FOREST ROAD PARENT TEACHER ASSOCIATION

ELECTED OFFICERS 1974-1975

<i>President</i>	GINNY LEVINE	872-9165
<i>First Vice President</i>	LYDIA ROSEN	791-5488
<i>Second Vice President</i>	SHELLY KOVAL	791-1232
<i>Third Vice President</i>	JUDY ORLOFF	791-3820
<i>Fourth Vice President</i>	RUTH BAZIL	791-8556
<i>Treasurer</i>	EDITH MAGEE	561-7064
<i>Financial Secretary</i>	DORIS BERNANKE	791-3790
<i>Corresponding Secretary</i>	PAULETTE KIRSCHENBAUM	791-7045
<i>Recording Secretary</i>	MARIE BRIODY	791-5817
<i>Delegates to Council</i>	RHODA BLAUSTEIN	791-6475
	MARIE SPIWAK	791-3307

<i>Newsletter</i>	MARIE SPIWAK	791-3307
<i>Parliamentarian</i>	CORKY SHAW	791-8807
<i>Posters</i>	PRUDY LOTIERZO	791-1381
<i>Pre-School</i>	LYDIA ROSEN	791-5488
<i>Program Chairman</i>	SHELLY KOVAL	791-1232
<i>Publicity</i>	BARBARA SMERLING	791-2540
<i>School Bd. Rep.—Elem.</i>	NANCY CESTA	791-8028
<i>School Bd. Rep.—High</i>	BARBARA ROVIN	791-1360
<i>Teacher's Rep.</i>		
<i>Typist</i>	TERRY SCHULTZ	561-2989

COMMITTEE CHAIRMEN

<i>Amblyopia</i>	JUDY ORLOFF	791-3820
<i>Bowling (Adult)</i>	EVELYN GRABOIS	791-1604
<i>Bowling (Children)</i>	DORIS BERNANKE	791-3790
<i>Budget</i>	FELICIA KATZ	791-9501
<i>Class Mothers</i>	IRENE BOCHNER	791-6351
<i>Cultural Arts</i>	TOBY KALLER	791-2104
<i>Children's Theatre</i>	RUTH BAZIL	791-8556
<i>Ecology</i>	RHODA BLAUSTEIN	791-6475
<i>Family Living</i>	JUDY ORLOFF	791-3820
<i>Flyers</i>	TRENA DANELS	791-1506
<i>Goodwill</i>	MARIE BRIODY	791-5817
<i>Hospitality</i>	RUTH BAZIL	791-8556
<i>Health & Safety</i>	ABBY TEDESCO	791-2157
<i>Historian</i>	ELLEN FILLER	872-6377
<i>Legislation</i>	CAROL PROVANZANO	825-5915
<i>Membership</i>	LINDA ZAHN	791-4516
<i>Mimeograph</i>	PHYLLIS SELTZER	791-2376
	CLAIRE GENDELMAN	791-5811
	AUDREY RUMPH	791-5794
	DONNA LOBEL	791-4568
	MARION LOWENBRAUN	791-3980
	BETTY SABATTINI	791-8165
	DORIS BERNANKE	791-3790
	ANITA SURIANI	791-3960
	KATHY MCCLELLAN	872-9794

P.T.A. PROGRAM

Sept.	10	Bowling Starts, 12:30 P.M.
	11	Meet the Teacher Night, 8:30 P.M.
Oct.	4	5th and 6th Grade Bowling Starts
	16	Executive Board Meeting, 9:45 A.M.
	25	6th Grade Halloween Party
Nov.	6	Executive Board Meeting, 9:45 A.M.
	13	Pre-School Meeting, 3:00 P.M.
Dec.	4	Executive Board Meeting, 9:45 A.M.
	12	Pre-School Meeting, 2:00 P.M.
Jan.	8	Executive Board Meeting, 9:45 A.M.
	15	Pre-School Meeting, 2:00 P.M.
Feb.	5	Executive Board Meeting, 9:45 A.M.
	20	Pre-School Meeting, 3:00 P.M.
Mar.	5	Executive Board Meeting, 9:45 A.M.
	17	Family Living Program, Parents, Grades 4, 5, 6, 8:00 P.M.
	18	Family Living Program, 5th Grade Boys and Girls, 2:45 P.M.
	19	Pre-School Meeting, 2:00 P.M.
	20	Family Living Programs: 6th Grade Girls and Mothers, 7:00 P.M.; 6th Grade Boys and Fathers, 8:30 P.M.
Apr.	2	Executive Board Meeting, 9:45 A.M.
	17	Pre-School Meeting, 3:00 P.M.
	24	Family Living Program, 4th Grade Girls, 3:00 P.M.
	30	Executive Board Meeting, 9:45 A.M.
May	14	Teachers' Recognition Day Luncheon, 11:30 A.M.
	21	General Meeting and Installation, 8:30 P.M.
June	4	Joint Executive Board Meeting, 9:45 A.M.

FEBRUARY 1975

DAY	MONDAY	TUESDAY	WEDNESDAY	THURSDAY	FRIDAY	SATURDAY
						1
2	3 PTA Council Meeting, 8:00 P.M., Donahue School	4	5 PTA Exec. Bd. Mtg., Forest, 9:45 A.M.	6 PTA Exec. Bd. Mtg., Clear Stream, 9:30 A.M. PTA Cake Sale, Clear Stream, 2:45 P.M.	7 PTA's Happy Birthday for Shaw (25 yrs.) 8:00 P.M.	8
9	10	11 C.H.S. Bd. Mtg., 8:00 P.M. SCHOOL CLOSURES AT REGULAR TIMES FOR WINTER RECESS	12 WINTER RECESS SCHOOL CLOSED	13 WINTER RECESS SCHOOL CLOSED	14 WINTER RECESS SCHOOL CLOSED	15
16	17 WINTER RECESS SCHOOL CLOSED	18 SCHOOL REOPENS	19 PTA Exec. Bd. Mtg., Shaw, 1:00 P.M. PTA Founders' Day Celebration, Clear Stream, 8:30 P.M.	20 Pre-School Mtg., Forest, 3:00 P.M.	21	22
23	24	25 PURIM Dist. #30. Bd. of Ed. Mtg., 8:15 P.M.	26	27 PTA Human Relations Workshop (Alcoholism in Youth) Clear Stream,	28	

ughter, of course, is in activity not of the jaw muscles, but of the mind; indeed, silent laughter is usually the most
g and satisfied form of mirth with which to confront matters of the profoundest import. The ability to laugh,
tly or aloud, at moments of ultimate crisis is a sublime attribute; an expression of everything in us that is
an and most civilized.

— Julius Novick

THE EDUCATIONAL TEAM—TEACHER, SPECIALISTS AND ADMINISTRATORS

The focus of any educational team must be the child. The preparation of that child to assume an adult role in society should be the ultimate aim of the school. In order to achieve this goal the child must develop basic skills, and a general fund of information which will allow him to develop a feeling of responsibility and confidence in himself. The rapid changes in patterns of society as well as the ever increasing amounts of technical knowledge makes this a huge assignment.

The classroom teacher is the key member of any educational team and it is his responsibility to diagnose the instructional needs of each pupil and to prescribe those learning experiences which will satisfy these needs. He must also see the child in relation to his peers in order to properly determine his social needs. Other members of the educational team who represent a variety of disciplines and who are experts in their respective fields are available to assist the teacher in working with their pupils. The educational team is coordinated by district administration. The members of the team are as follows:

THE ADMINISTRATIVE TEAM:

Each member of the administrative team was selected for his expertise in one or more curriculum areas in addition to general administrative training, therefore each building administrator aside from his building responsibilities is assigned to one or more curriculum areas for which he has district wide responsibility. All curriculum areas are coordinated by the administrative assistant for curriculum who reports directly to the District Principal the status of each area.

DIRECTOR OF EDUCATIONAL COMMUNICATION:

One of the primary functions of this member of the team is to foster learning opportunities for all pupils. This is accomplished by exposing the individual student to a myriad of audio visual materials and equipment which is best suited to his own individual learning style and educational needs. The Director of Educational Communications, is therefore, actively involved in the selection and evaluation of all non print learning resource materials. These of course are chosen on the basis of individual needs of children, as well as their ability to meet district curriculum goals and courses of study.

NURSE:

The three nurse-teachers, in addition to being responsible for the general health and welfare of the children in their individual buildings, also act in an advisory capacity to formulate and implement the health curriculum. They also speak

ers and display on a variety of topics concerning health and safety and occasionally, upon request, go into the classroom to teach. All information concerned with the physical health of children is processed through each building's health office.

PSYCHOLOGIST:

The school psychologists administer individual tests, interview teachers, consultants, and parents and on the basis of their findings recommend procedures for teachers to use in the classroom to satisfy individual pupil needs. They also make referrals to outside agencies for some pupils.

READING CONSULTANTS AND SPECIALISTS:

This part of the team includes four members—one reading consultant and three reading specialists. The reading consultant coordinates the work of the reading specialists. Each specialist is assigned to a building where she is responsible, under the direction of the reading consultant, for teacher workshops, diagnostic testing, demonstration lessons, consultation with teachers, and remedial reading instruction.

SPECIAL COUNSELORS:

There is one special counselor in each building. Their function is to provide support for pupils who are experiencing personal or social difficulties. Occasionally they provide academic support through a non-directed method for pupils who need success in this area. They are also available to pupils who have had a traumatic experience and who need someone in whom they can confide. Through the use of this type of outlet serious psychological problems are often avoided.

SPEECH CONSULTANT AND SPEECH TEACHER:

The two members of this department perform two services. First, they conduct a developmental speech program in the kindergartens and first grades, coordinated with the reading readiness program, and secondly they conduct a speech correction program for children who have been diagnosed to have such a need.

The work of all these specialists is coordinated by the Administrative Assistant/Curriculum, who conducts weekly meetings with them at which time individual pupils are discussed as to their progress, or lack of it, and further plans may be made as to how to handle these special cases. *The emphasis is on the child, and it is felt that all members working together as a team will surely prove of benefit to the child so that every pupil will have the opportunity to progress to the utmost of his ability.*

MARCH 1975

SUNDAY	MONDAY	TUESDAY	WEDNESDAY	THURSDAY	FRIDAY	SATURDAY
						1
2	3 Pre-School Mtg. (Parents & 4 yr. olds) Clear Stream, 1:30 P.M.	4	5 PTA Exec. Bd. Mtg., Forest, 9:45 A.M. PTA Exec. Bd. Mtg., Clear Stream, 1:30 P.M.	6 PTA Fashion Show, Shaw "Lights On For Education", Memorial J.H.S.	7 Father-Son-Daughter Night, Clear Stream, 7:30 P.M.	8
9	10 Pre-School Mtg., Shaw & Washington, 3:00 P.M.	11 C.H.S. Bd. of Ed. Mtg., 8:00 P.M.	12	13	14 District Music Concert, Shaw, 8:15 P.M.	15 PTA Ecology Drive (5th Grades) Shaw, 9-12 Noon
16	17 Parents Preview Family Living Film (4-5-6) Forest, 8:00 P.M.	18 Family Living Film— 5th Gr. Boys & Girls — Forest, 2:45 P.M. Dist. #30 Bd. of Ed. Mtg., 8:15 P.M.	19 PTA Exec. Bd. Mtg., Shaw, 1:00 P.M. Pre-School Mtg., Forest, 2:00 P.M.	20 Fam. Liv. Prog.: 6th Gr. Girls & Mothers, 7:00- 8:30 P.M.; 6th Gr. Boys & Fathers, 8:30-10 P.M., Forest; PTA Gen. Mtg., Clear Stream, 3:00 P.M.	21 PTA Cultural Arts Assembly, Shaw SCHOOL CLOSURES AT REGULAR TIMES FOR EASTER RECESS	22
23 EASTER RECESS SCHOOL CLOSED	24 EASTER RECESS SCHOOL CLOSED	25 EASTER RECESS SCHOOL CLOSED	26 EASTER RECESS SCHOOL CLOSED	27 FIRST DAY OF PASSOVER HOLY THURSDAY	28 SECOND DAY OF PASSOVER GOOD FRIDAY	29
30 SCHOOL CLOSURE	31 SCHOOL CLOSURE					

EDUCATIONAL SCHOOL SYSTEMS — VALLEY STREAM

In deference to the new residents of the district, and a refresher to those who have lived here for a while, we present an explanation of the make-up of the Valley Stream schools.

There are three elementary school districts (Nos. 13, 24, and 30) which are separate and autonomous. Each of these has school boards elected by the taxpayers of that district and each has its own budget upon which its voters must pass in any given year.

The Board of Education of Central High School District No. 1 is made up of three members from each of the three elementary school districts. These members are elected to serve on the high school board by the elementary school boards of education.

The Central High School budget is separate from the elementary budgets but is voted on each year at the same time — usually the first Wednesday in May.

Notwithstanding that each district is autonomous unto itself, there is great collaboration among the four districts. The Boards of Education have formed what is called the "Joint Boards" which meets several times each year to consider matters of mutual concern — i.e., teacher salaries and bylaws.

Cooperation among the districts is epitomized by a committee composed of representatives of each elementary district and the high school district (the Inter-district Committee). These staff members meet at least once a month and coordinate such matters as assignment of student teachers; curriculum areas, such as social studies, to insure continuity from the elementary schools to the high schools; the setting up of village-wide in-service courses for teachers; forming of evaluation committees to study some particular program (such a committee is now assessing our Foreign Language Program); and many other areas of concern to all Valley Stream schools.

The following diagram depicts just how the school districts are set up.

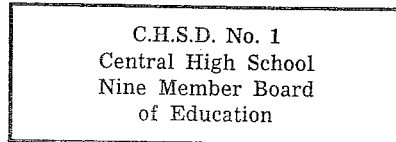

Three members of each elementary board of education are elected by the individual elementary boards to serve on the high school board of education.

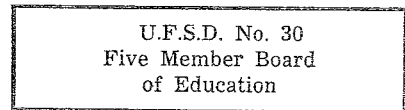
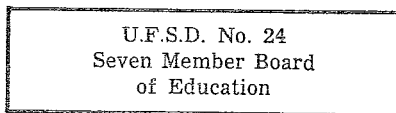
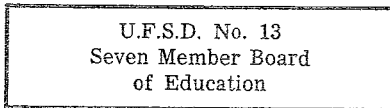

Taxpayers of this district vote on their own budget and school board members.

Taxpayers of this district vote on their own budget and school board members.

Taxpayers of this district vote on their own budget and school board members.

Taxpayers from three districts vote on the high school budget.

APRIL 1975

SUNDAY	MONDAY	TUESDAY	WEDNESDAY	THURSDAY	FRIDAY	SATURDAY
<p>man empties his purse into his no man can take it away from an investment in knowledge pays best interest. — B. Franklin</p>	1	2	<p>SEVENTH DAY OF PASSOVER. PTA Exec. Bd. Mtg., Forest, 9:45 A.M. PTA Exec. Bd. Mtg., Clear Stream, 1:30 P.M.</p>	3	4	<p>Vision Screening, Clear Stream, 9:00 A.M.</p>
6	<p>Pre-School Mtg., (Parents of 3 year olds) Clear Stream, 1:30 P.M.</p>	8	9	10	11	<p>PTA Ecology Drive (Clean Up Day) Shaw, 9:00 A.M. to 12:00 Noon</p>
13	<p>PTA Council Meeting, Howell Road, 8:00 P.M.</p>	15	<p>PTA Gen. Mtg., Shaw, 8:15 P.M. Helen Beyer, Oriental Cooking</p>	17	<p>Pre-School Mtg., Forest, 3:00 P.M. PTA Cultural Arts Program, Clear Stream, 1:30 P.M.</p>	19
20	21	22	<p>Teacher Recognition Day, Clear Stream, 11:00 A.M.</p>	24	<p>Sex Hyg. Mtg., (6th Gr. Boys) Shaw, Fam. Liv. Prog., (4th Gr. Girls) Forest, 3:00 P.M. Hyg. Film, 4th Gr. Girls, Clear Stream, 3:00 P.M.</p>	25
27	28	29	30	<p>We can secure other people's approval if we do right and try hard; but our own is worth a hundred of it and no way has been found out of securing that. —Mark Twain</p>		

SCHOOL POLICIES

SCHOOL HOURS

hours for grades 1, 2, and 3 are from 9:00 a.m. to 3:00 p.m.
 hours for grades 4, 5, and 6 are from 8:30 a.m. to 2:45 p.m.

LUNCH

Lunch is served beginning with the first day of school. Pupils may go home for lunch, bring lunch from home, or buy the school lunch in the cafeteria for 50c. Monthly menus are provided so that if foods are served which your child does not eat, you can make other provisions for him for those days. In case a child forgets his lunch money or his lunch, or loses either, we have a charge system to cover the emergency. The cashier in the cafeteria keeps the record of such charges and contacts the parents to make a charge not be paid in a reasonable time.

ICE CREAM

Ice cream is sold daily to those pupils who wish it. It is not included in the hot lunch and costs an additional 10c.

RECESS MILK

Recess milk is available to all children beginning about the first week of the school year and is sold at a cost of 40c per week available each Thursday for the following week. You will be notified as to the exact date. Money brought in late (Friday) cannot be accepted. In case of a child's absence, no refund is made for periods of less than a full week.

ABSENCES

When your child has been absent, State law requires that he bring a note from you explaining the absences and the date(s) of absence(s). The note should be presented to the nurse before going to the classroom. Please be specific. Just saying, "he was sick" is not enough. Indicate whether it was "virus," "fever," "cold," etc. A note is required for an absence due to a religious holiday. A note is required for any tardiness, giving the reason. If your child contracts a contagious disease, such as mumps, measles, etc., please phone the school nurse so that she can notify the parents in your child's class that their children have been exposed. Be sure to keep the emergency card up to date that you will know whom to call should your child become ill and have to go home.

NOON HOUR RULES

When pupils misbehave in the cafeteria, auditorium, or on the playground during the noon hour, after repeated reminders, the teachers have the authority to exclude them from staying in school for lunch for a few days, or longer, depending on the misbehavior. If you receive such a note from us, we would appreciate your cooperation. Whether or not a mother is home during the noon hour has no bearing on this exclusion.

RELEASED TIME FOR RELIGIOUS INSTRUCTION

A Release Form signed by the parent is necessary should you want your child excused from school for religious instruction. Such forms can be obtained from your church. The time provided is the last hour of school on Wednesday afternoons.

EXITS AND ENTRANCES

Your child's class is assigned a specific exit and entrance to use. You will thus know where to meet him if you come to pick him up. Parents picking up children are asked to meet them at the exit, *not the classroom*.

ENTRANCE TIMES

Morning — All Schools	Noontime — Shaw & Forest
Grades 1, 2, & 3 — 8:50	Grades 1, 2, & 3 — 12:50
Grades 4, 5, & 6 — 8:20	Grades 4, 5, & 6 — 12:20
Noontime — Clear Stream: Grades 5 & 6 — 12:05	
Grades 3 & 4 — 12:35; Grades 1 & 2 — 1:05	

Because there is no supervision of the playground in the morning, we suggest you arrange your child's departure from home to allow him to arrive just in time to enter the building during the proper interval. In inclement weather he may come into the designated area five minutes before the above times.

CLASS INTERRUPTIONS

No unnecessary interruptions of classes are allowed once the day's sessions have begun. When your child forgets a book, homework, sneakers, lunch money, etc., please bring these to the office. All pupils are instructed to check with the office at lunch time for such forgotten items. In the interest of the child's all-round education, we urge you not to make a practice of bringing forgotten items to school. The child should be developing his own sense of responsibility for these things.

MAY 1975

SUNDAY	MONDAY	TUESDAY	WEDNESDAY	THURSDAY	FRIDAY	SATURDAY
				PTA Mothers' Day Boutique, Shaw & Washington PTA Mothers' Day Boutique, Clear Stream, 2:45 P.M.	Mother-Daughter Buffet Supper, Clear Stream, 7:00 P.M. PTA Mothers' Day Boutique, Clear Stream, 2:45 P.M.	
	Sex Hygiene Mtg., 5th & 6th Gr. Mothers, Shaw, 1:00 P.M. Art Exhibit, Forest, 7:30-9:00 P.M.		Sex Hyg. Mtg., 5th Gr. Girls, Shaw, 3:00 P.M. Voting on School Budget, 7:00 A.M. to 10:00 P.M. All Schools PTA Exec. Bd. Mtg., Clear Stream, 1:30 P.M.			Sex. Hyg. Mtg., 6th Grade Girls, Shaw, 3:00 P.M.
		C.H.S. Bd. of Ed. Mtg., 8:00 P.M.	Teachers' Recognition Day Luncheon, Forest, 11:30 A.M.	Teachers' Recognition Day, Shaw PTA Gen. Mtg. (Spring Concert Installation) Clear Stream, 7:30 P.M.	SHAVOUT	SHAVOUT
		Art Exhibit, Clear Stream, 7:30-9:00 P.M. PTA Cake Sale, Clear Stream, 7:30 P.M.	PTA Gen. Mtg. (Installation) Shaw PTA Installation, Forest, 8:30 P.M.	Art Exhibit, Shaw, 7:30-9:00 P.M.		PTA Ecology Drive (4th Grades) Shaw, 9:00 A.M. to 12:00 Noon
	MEMORIAL DAY SCHOOL CLOSED	Dist. #30 Bd. of Ed. Mtg., 8:15 P.M.				

SCHOOL POLICIES

GYM SUITS AND SNEAKERS

Gym suits are required of pupils below the 3rd grade, but sneakers are necessary for any pupils using the gym. Boys and girls from the 3rd through 6th grades are required to wear gym suits and sneakers on the assigned gym days. The gym teachers explain this to the pupils, but many times they do not bring correct information home.

Who MUST PURCHASE A NEW SUIT should buy the piece ROYAL BLUE, bloomer type, with elastic bottoms, or ROYAL BLUE shorts with elastic insert in the cuff, and a white t-shirt. Boys should wear ROYAL BLUE shorts, with elastic top, sneakers (high top ones preferred), and white or SCHOOL "T" shirts.

IF A CHILD HAS ANOTHER COLOR, OR TYPE, HE DOES NOT HAVE TO BUY A NEW ONE. The above apparel may be purchased at many local stores in Valley Stream. NO ONE IS ALLOWED ON THE GYM FLOOR WITHOUT SNEAKERS.

APPOINTMENTS WITH TEACHERS

In order that pupils' classtime be used to the fullest advantage, we request that parents do not seek conferences with teachers during school hours. If you wish a conference, please make an appointment to see the teacher after school. Teachers are available for such conferences every day except Wednesdays and Fridays.

BICYCLES

Bicycles are allowed at either Forest Road or Clear Stream Intermediate Schools because no child lives far enough from the school to make them necessary. They are allowed at Shaw, but are restricted to pupils in grades 4, 5, and 6 who live NORTH OF CLEAR STREAM AVENUE. Bicycles used to come to the Shaw Avenue School will be assigned a number. All must have a lock and helmet for safety purposes.

GIFTS TO TEACHERS PROHIBITED

A policy of the school district which became effective January 1, 1956, is to prohibit the acceptance of gifts by faculty members on school premises, and to prohibit the solicitation of funds for personal gifts purposes, by any person, or person on the premises.

IN-DAY PROGRAM

In inclement weather, there is an in-day program of motion pictures provided for those pupils who eat in the cafeteria. Pupils who go home to lunch are not allowed to participate in this program because of space limitations, so we ask parents to return these pupils to school on such days just in time for the afternoon session—not before 12:50 p.m. for grades 1 to 3, and 12:20 p.m. for grades 4 to 6 at Shaw and Forest; and not before 12:05 for grades 5 and 6, 12:35 for grades 3 and 4, and 1:05 for grades 1 and 2 at Clear Stream.

HOMEWORK REQUIREMENTS

Homework is required of all pupils, but it will vary from day to day. First and second grade pupils may have fifteen to twenty minutes of homework per day, while third and fourth grade pupils are likely to have thirty to forty minutes. Fifth and sixth graders are expected to devote as much as an hour to homework, but again this may not be every day—it will depend on the pupil and his needs.

LOST AND FOUND

Unmarked articles lost by pupils are placed in the Lost-and-Found, which is in the Nurse's Office at Shaw & Forest, and the custodian's office at Clear Stream. Such articles, if not claimed at the end of the school year, are given to a charitable organization. However, any article bearing a child's name is returned directly to him. Please place your child's name on all his belongings.

STAYING AFTER SCHOOL

To eliminate any confusion or problems, the school may have your child every day for an additional half hour. During this half hour beyond the regular school day, the teacher may schedule your child for special help or keep him for any of several reasons. We ask that you keep this in mind and not schedule dental appointments, dancing lessons, etc. until after that interval. Teachers are also available to parents during the half hour after school, except on Wednesday and Friday, for conferences.

ASSEMBLIES

When your child's class puts on the assembly, we welcome your attendance, but we do ask you not to bring pre-school children. As much as we realize that it is a thrill for them to see a big brother perform, they are often distracting to all concerned. Picture taking is not allowed without prior approval.

JUNE 1975

SUNDAY	MONDAY	TUESDAY	WEDNESDAY	THURSDAY	FRIDAY	SATURDAY
1	2 String Recital, Shaw, 7:30 P.M. PTA Council Meeting, North, 8:00 P.M.	3 String Recital, Clear Stream, 7:30 P.M.	4 String Recital, Forest, 7:30 P.M. PTA Joint Exec. Bd. Mtg., Shaw, 1:00 P.M. PTA Joint Exec. Bd. Mtg., Forest, 9:45 A.M. PTA Joint Exec. Bd. Mtg., Clear Stream, 8:00 P.M.	5	6	7
8	9	10 C.H.S. Bd. of Ed. Mtg., 8:00 P.M.	11	12 PTA Fathers' Day Boutique, Shaw & Washington Human Relations Workshop (Drugs & Youth) Clear Stream, 3:00 P.M.	13	14
15	16	17	18 Closing Exercises for 6th Grade	19	20 LAST DAY OF SCHOOL	21
22	23	24 Dist. #30 Bd. of Ed. Mtg., 8:15 P.M.	25	26	27	28
29	30	Herein lies the tragedy of the age: not that men are poor—all men know something of poverty; not that men are wicked—who is good? Not that men are ignorant—what is truth? Nay, but that men know so little of men. — William DuBois				

SHAW AND WASHINGTON AVENUE SCHOOLS

CLASS MOTHER LIST

Class Mother Chairman Cathy Rosenbaum, 285-5059

Room	Class Mother	Tel. Number	Teacher
Kindergarten Representative Marianne Farella, 285-6924			
301 AM	Mrs. Waite	285-7955	Miss Stelzer
301 PM	Mrs. Farella	285-6924	Miss Stelzer
101 AM	Mrs. Gardner	285-7086	Miss Blessinger
101 PM	Mrs. S. Viggiano	872-9381	Miss Blessinger
1st Grade Representative Ginny DiNonno, 561-1785			
302	Mrs. Allora	285-7269	Mrs. Hartman
303	Mrs. Kirschner	285-6783	Mrs. Lazar
103	Mrs. Manzo	872-8717	Mrs. Levine
105	Mrs. Pisano	872-3097	Mrs. Barra
106	Mrs. Ameruso	825-0959	Mrs. Graffigino
2nd Grade Representative Camille Audino, 285-6212			
126	Mrs. Magnus	825-8038	Miss Shapiro
128	Mrs. Audino	285-6212	Mrs. S. Cohen
130	Mrs. Nazzaro	825-4741	Miss J. Cohen
133	Mrs. Giacalone	825-3854	Mrs. King
3rd Grade Representative Jo Anne Igljo, 285-6458			
104	Mrs. Kropas	872-8117	Mrs. Sweet
107	Mrs. Rosenbaum	285-5059	Mrs. Strumpf
132	Mrs. Abandola	285-7792	Mrs. Stevens
135	Mrs. Piemonte	285-8032	Mrs. Federici

Gr.	Room	Class Mother	Tel. Number	Teacher
4th Grade Representative Jeanette Allora, 285-7269				
4	108	Mrs. Mazza	285-7926	Mr. Carr
4	109	Mrs. Nickdow	285-4869	Mrs. Benedetto
4	110	Mrs. Nugent	872-6378	Mr. Riccobono
4	114	Mrs. Schlaeger	285-7588	Mrs. Stiefel
5th Grade Representative Connie Montana, LO 1-0267				
5	116	Mrs. Woods	285-8137	Miss Melzer
5	118	Mrs. Kelly	825-0113	Mrs. Hamcke
5	121	Mrs. Mosca	825-0414	Mrs. Seid
5	122	Mrs. S. Jacobs	872-3144	Mr. Beyer
6th Grade Representative Louise Kiel				
6	123	Mrs. Ging	285-6072	Miss Lanell
6	124	Mrs. Zeiner	285-9898	Mrs. Sherman
6	125	Mrs. Rosenblatt	825-3315	Mrs. Haydock
6	127	Mrs. Kiel	285-9651	Mr. Giacalone
Special				
CL	131	Mrs. Accardi	285-4811	Mrs. Lewis

JULY 1975

SUNDAY	MONDAY	TUESDAY	WEDNESDAY	THURSDAY	FRIDAY	SATURDAY
When a great man dies ars beyond our ken ght he leaves behind him lies he paths of men — Longfellow		1	2	3	4 INDEPENDENCE DAY	5
6	7	8 C.H.S. Bd. of Ed. Mtg., 8:00 P.M.	9	10	11	12
13	14	15	16	17	18	19
20	21	22 Dist. #30 Bd. of Ed. Mtg., 8:15 P.M. (Tentative)	23	24	25	26
27	28	29	30	31		

CLEAR STREAM AVENUE SCHOOL

CLASS MOTHER LIST

Grade	Room	Class Mother	Tel. Number	Teacher
K	AM	9 Mary Frost	561-0889	Andrea Eden
K	AM	9 Terry Gruenfelder	285-8034	Andrea Eden
K	AM	9 Mary Tragner	285-9502	Andrea Eden
K	AM	9 Mary Werkmeister	872-8987	Andrea Eden
K	PM	8 Ann Guagliardo	825-6879	Gail Starler
K	PM	8 Frances Passarelli	872-9429	Gail Starler
K	PM	8 JoAnne Santoro	285-8905	Gail Starler
K	PM	8 Rebecca Sheil	285-7779	Gail Starler
K	PM	9 Fran Gentile	872-3206	Andrea Eden
K	PM	9 Marge Limthong	561-2981	Andrea Eden
K	PM	9 Barbara McLaughlin	825-6162	Andrea Eden
K	PM	9 Angela Nardo	561-2410	Andrea Eden
1	A	Lucille Bertorello	872-3577	Mary Patterson
1	A	Lorraine Guibas	285-6711	Mary Patterson
1	A	Eleanor O'Brien	285-5643	Mary Patterson
1	A	Jean Sivillo	825-6003	Mary Patterson
1	B	Kay Margagliano	872-3958	Dorothy Schaaf
1	B	Kaye Pesce	285-5178	Dorothy Schaaf
1	B	Rosemary Smith	561-8667	Dorothy Schaaf
1	B	Madeline Weiss	825-1719	Dorothy Schaaf
1	7	Fran Ciniglio	285-7996	Pamela Lauria
1	7	Martha DeKnatel	285-7310	Pamela Lauria
1	7	Ann Prisco	285-5744	Pamela Lauria
2	2	Ruth Settepani	285-5725	Pamela Lauria
2	2	Bernice Castello	561-0241	Dale Schindelman
2	2	Sandy Henry	825-6572	Dale Schindelman
2	2	Fran Zizzo	825-2396	Dale Schindelman
2	2	Joan Hollywood	285-8719	Dale Schindelman
2	5	Eileen Calandrino	825-6470	Virginia Galati
2	5	Joan Bauer	285-5049	Virginia Galati
2	5	Marie Presti	285-9034	Virginia Galati
2	5	Marge Rollo	825-0929	Virginia Galati
2	6	Sue Farrell	872-8026	Lillian Guberman
2	6	Terry Keller	285-7016	Lillian Guberman
2	6	Cheryl Holton	561-9955	Lillian Guberman
2	6	Lenore Vita	285-5394	Lillian Guberman
3	1	Elizabeth Accomando	285-9315	Karen Firpo
3	1	Ann Ciaramello	285-5072	Karen Firpo
3	1	Ann Finazzo	285-6680	Karen Firpo
3	1	Stella Rusinyak	285-8094	Karen Firpo
3	4	Mary Cascio	872-9078	Louise LeJeune Quinn
3	4	Pat Lynch	825-5958	Louise LeJeune Quinn
3	4	Rose McMeekin	285-4925	Louise LeJeune Quinn
3	4	Irene Uzzi	825-9221	Louise LeJeune Quinn
4	3	Marion Acquavella	825-2272	Helen Inwald
4	3	Blanch Bartsch	561-6034	Helen Inwald
4	3	Eleanor Leyh	825-0459	Helen Inwald
4	3	Marie Grande	561-1848	Helen Inwald
4	23	Marie Pascuzzi	825-8401	Barbara Nancken
4	23	Maureen Casey	285-9571	Barbara Nancken
4	23	Phyllis Capitano	872-8313	Barbara Nancken
4	23	Arlene Ercole	285-8127	Barbara Nancken
4	25	Marge Croak	825-9352	Gerard Camilleri
4	25	Dorothy Walz	825-6011	Gerard Camilleri
4	25	Marilyn Palazzo	872-3372	Gerard Camilleri
4	25	Joanne Esposito	285-6815	Gerard Camilleri
5	27	Claire DiNapoli	285-6275	Mrs. Shaw
5	27	Rose Ann Potter	872-9337	Mrs. Shaw
5	27	Jean Savarese	285-5116	Mrs. Shaw

5	27	Jennie Tretola	872-9527	Mrs. Totten
5	28	Fran Carnival	872-0433	Marie Gerdyk
5	28	Eleana Cirenza	285-5671	Marie Gerdyk
5	28	Netti Ghiradella	561-6450	Marie Gerdyk
5	28	Julie Sagginario	285-8670	Marie Gerdyk
6	21	Lois Barry	285-8654	David Cooper
6	21	Barbara Bevacqua	872-6516	David Cooper
6	21	Connie Deering	285-6210	David Cooper
6	21	JoAnn LaBarbera	285-9820	David Cooper
6	22	Gertrude Baewald	872-3253	Edith May Yelland
6	22	Gloria Corradi	285-5255	Edith May Yelland
6	22	Ruth Wikane	285-5618	Edith May Yelland
6	22	Regina Schneider	872-8409	Edith May Yelland
6	24	Rose Bochichio	285-4868	Judith Wiesen
6	24	Rosalie Cuillo	561-1925	Judith Wiesen
6	24	Terry Fileccia	561-0938	Judith Wiesen
6	24	Beverly Jablonowski	825-2489	Judith Wiesen

FOREST ROAD SCHOOL

CLASS MOTHER LIST

Class Mother Chairmen
Rhoda Blaustein, 791-6475 and Judy Orloff, 791-3820

Grade	Room	Class Mother	Tel. Number	Teacher
*K	AM	201 Lenora Paletz	791-5274	Mrs. Murray
K	AM	201 Donna Lobell	791-4568	Mrs. Murray
K	PM	201 Betty Fine	791-1806	Mrs. Murray
K	PM	201 Jeanette Barkolas	791-5334	Mrs. Murray
1	203	Barbara Sultan	791-8021	Miss Cafiso
1	203	Sandy Schaefer	872-0838	Miss Cafiso
1	204	Joan Frischling	791-7663	Mrs. Kalhofer
1	204	Linda Zahn	791-4516	Mrs. Kalhofer
2	205	Carol Provenzano	825-5915	Miss Perrich
2	205	Bea Spector	791-5216	Miss Perrich
2	206	Marsha Gordon	791-2863	Miss Post
2	206	Joyce Sprung	791-9122	Miss Post
2	207	Harriet Drucker	791-6452	Mrs. Cummings
2	207	Andrea Port	791-1460	Mrs. Cummings
3	209	Estelle Glazer	791-5308	Miss Clarke
3	209	Fran Oza	791-5865	Miss Clarke
3	210	Rhoda Blaustein	791-6475	Mrs. Cabral
3	210	Anita Suriani	791-3960	Mrs. Cabral
3	211	Kathy McClellan	872-9794	Mr. Lesser
3	211	Judy Orloff	791-3820	Mr. Lesser
3	215	Renee Pepper	791-3357	Miss Schwartz
3	215	Edith Magee	561-7054	Miss Schwartz
3	218	Paulette Kirschenbaum	791-7045	Mrs. Neuman
3	218	Abby Tedesco	791-2157	Mrs. Neuman
6	217	Pat Block	791-4920	Mrs. Melnick
6	217	Irene Bochner	791-6351	Mrs. Melnick
6	217	Nancy Cesta	791-8028	Mrs. Melnick
6	217	Trena Danels	791-1506	Mrs. Melnick
6	217	Shelly Koval	791-1232	Mrs. Melnick
6	217	Anita Strelisker	791-7165	Mrs. Melnick
6	220	Ruth Bazil	791-8556	Mr. Kaufman
6	220	Doris Bernanke	791-3790	Mr. Kaufman
6	220	Felicia Katz	791-9501	Mr. Kaufman
6	220	Corky Shaw	791-8807	Mr. Kaufman
6	220	Marge White	791-5361	Mr. Kaufman

*Grade Co-Ordinator

AUGUST 1975

MONDAY	TUESDAY	WEDNESDAY	THURSDAY	FRIDAY	SATURDAY
				1	2
3	4	5	6	7	8
10	11	12	13	14	16
		C.H.S. Bd. of Ed. Mtg., 3:00 P.M.			
17	18	19	20	21	22
24	25	26	27	28	29
31		Dist. #30 Bd. of Ed. Mtg., 8:15 P.M.			30

When you get into a tight place and everything goes against you, till it seems that you cannot hold on a minute longer, never give up then for that is just the place and time that the tide will turn.
— Harriet Beecher Stowe

**UNION FREE SCHOOL DISTRICT No. 30 AND
CENTRAL HIGH SCHOOL DISTRICT No. 1,
VALLEY STREAM, NEW YORK**

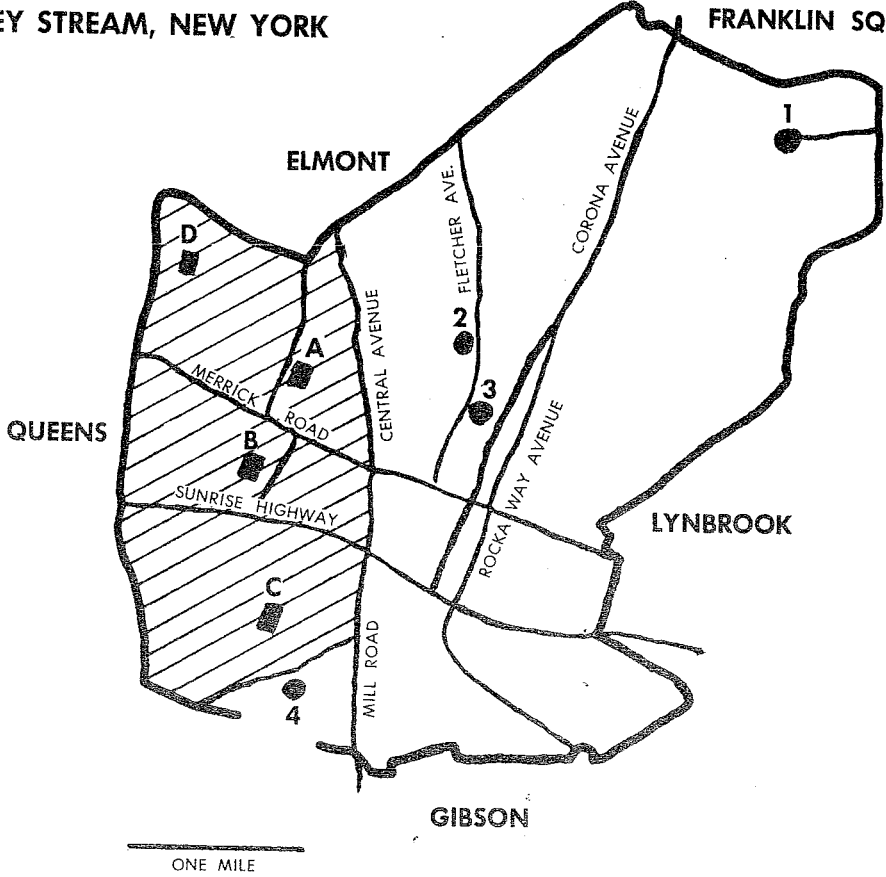

- DISTRICT No. 30 SCHOOLS**
- Shaw Avenue A
 - Clear Stream Avenue B
 - Forest Road C
 - Washington Avenue D
- Shaded Area — District 30

- HIGH SCHOOLS**
- North High 1
 - Memorial Junior 2
 - Central High 3
 - South High 4

SCHOOL TELEPHONE DIRECTORY

Principal's Office: SHAW AVENUE SCHOOL

Principal VA 5-9131

Assistant's Office VA 5-9131

Business Manager VA 5-9131

Washington Avenue School

Principal's Office VA 5-3044

Assistant's Office VA 5-3044

Clear Stream Avenue School

Principal's Office PY 1-7676

Assistant's Office PY 1-7676

Shaw Avenue School

Principal's Office VA 5-9131

Nurse's Office VA 5-9131

Washington Avenue School

Office VA 5-9131

Special Services

Administrative Assistant/Curriculum VA 5-9131

Psychologist VA 5-9131

Speech Consultant VA 5-9131

Reading Consultant PY 1-7676

Audio-Visual Consultant LO 1-1165

INDEX

Board of Education and School Calendar see October

Administration and Special Services see November

Clear Stream PTA see December

Shaw and Washington Ave. PTA see January

Forest Road PTA see February

The Educational Team — Teacher, Specialists and Administrators see March

Educational School Systems Valley Stream see April

School Policies see May and June

Shaw and Washington Class Mothers see July

Clear Stream and Forest Class Mothers see August

Map of District see facing page

CENTRAL HIGH SCHOOL DISTRICT NO. 1
Telephone Number: VA 5-8642

Use this number for all high school buildings, offices and personnel

NOTES

VALLEY STREAM UNION FREE SCHOOL
DISTRICT THIRTY

30

SCHOOL ACTIVITIES

Calendar

FOR 1974-1975

PUBLISHED BY THE BOARD OF EDUCATION AND PARENT-TEACHER ASSOCIATIONS

VALLEY STREAM UNION FREE SCHOOL
DISTRICT THIRTY

30

SCHOOL ACTIVITIES

Calendar

FOR 1976-1977

PUBLISHED BY THE BOARD OF EDUCATION AND PARENT-TEACHER ASSOCIATIONS

INDEX

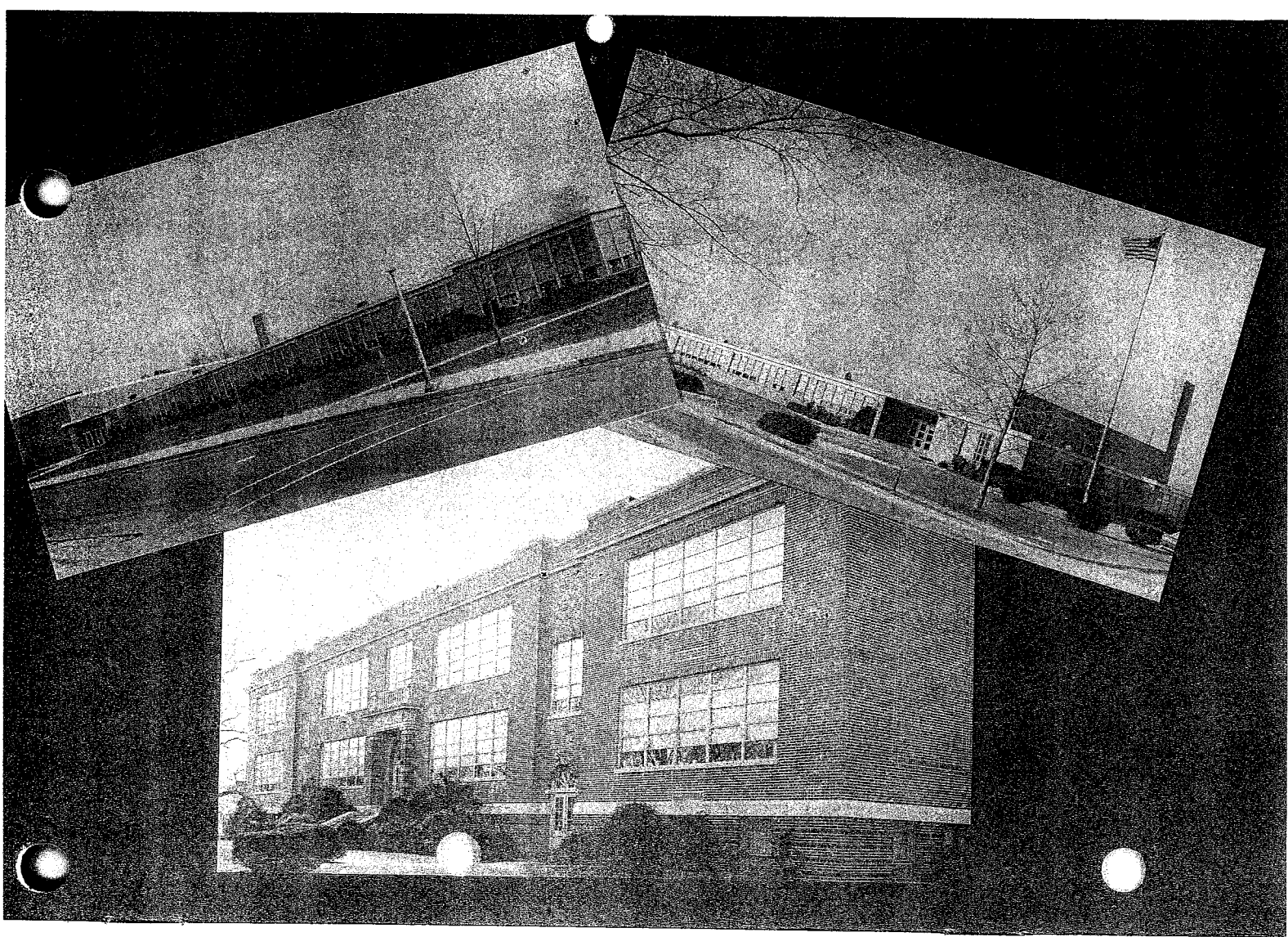

SEPTEMBER 1976

SUNDAY	MONDAY	TUESDAY	WEDNESDAY	THURSDAY	FRIDAY	SATURDAY
<p>need not know everything to be adequate, but one certainly have a field of perceptions rich and extensive enough to provide understanding of the events in which he is enmeshed and available when he needs them. Adequate people have such perceptual fields.</p> <p style="text-align: right;">—Arthur W. Combs</p>			1	2	3	4
5	6 LABOR DAY	7 Faculty Meeting	8 SCHOOL OPENS	9 PTA Ex. Bd. Mtg., Clear Stream, 9:30 A.M.	10	11
12	13 Gr. 4, 5, 6, Jr. Bowling Mtg., Shaw, 3:00 P.M.; Gym Shirt & Shorts Sale, Forest, 2:45 P.M.	14 C.H.S. Bd. of Ed. Mtg., 8:00 P.M.	15	16 Parents' Night, Shaw, Grs. 4-6, 8:15 P.M.	17	18
19	20 Jr. Bowling Starts, Shaw	21	22 PTA Ex. Bd. Mtg., Shaw 1:00 P.M.; PTA Gen. Mtg., & Parents' Night, Grs. K-3, Clear Stream, 7:30 P.M.; PTA "Meet the Teacher Night," Forest, 8:15 P.M.	23 Parents' Night, Shaw, Grs. K-3, 8:15 P.M.; PTA Bowling Starts, Shaw; PTA Gen. Mtg., Parents' Night, Grs. 4-6, Clear Stream, 7:30 P.M.	24	25 ROSH HASHANAH
26 HASHANAH	27	28 Dist. #30 Bd. of Ed. Mtg., 8:15 P.M. Parents' Night,	29	30	<p>For the development of a fully functioning self, a person needs to have opportunity to live the life good to live. This life, or his world, needs to be populated by people whom he can view as facilitating. It is entirely a</p>	

BOARD OF EDUCATION

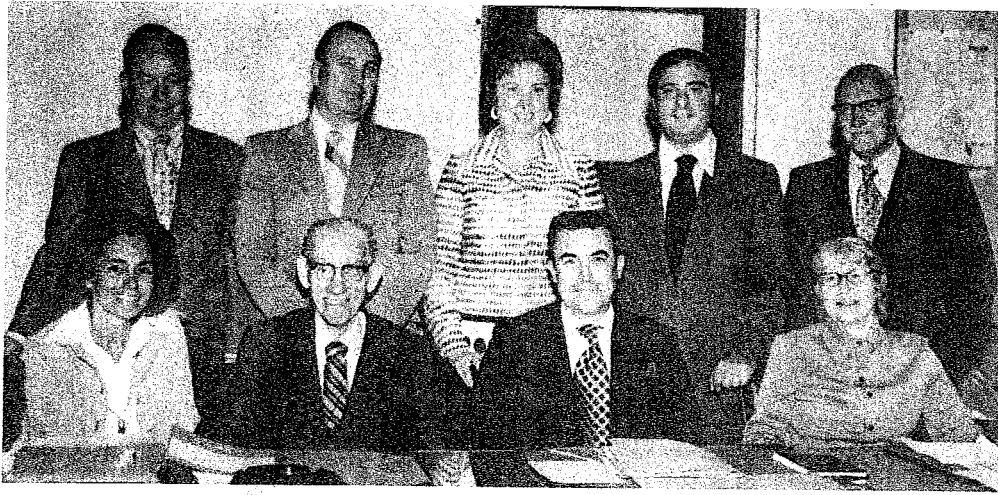

Standing (left to right): Sherwood S. Quick, District Principal; Charles E. Pearn, Eleanor Zeller, District Clerk; Stephen Bazil*, George Adams, School Attorney; Seated: Eleanor Berger, District Treasurer; Robert H. Bell, President; Joseph M. Barry*, Elinor McAuliffe*.
 *Also serves on High School Board.

SCHOOL CALENDAR, 1976-77

Meeting	Tues., Sept. 7	Christmas Recess	Dec. 24 thru Jan. 2
Opens for Students	Wed., Sept. 8	Winter Recess	Reopen Mon., Jan. 3
Kippur	Mon., Oct. 4	Easter-Passover	Feb. 21 thru Feb. 27
Yom Kippur Day	Mon., Oct. 11	Memorial Day	Reopen Mon., Feb. 28
Thanksgiving Day	Tues., Nov. 2	Last Day of School	Apr. 4 thru Apr. 11
Teachers' Day	Thurs., Nov. 11		Reopen Tues., Apr. 12
Thanksgiving Recess	Nov. 24 thru 28		May 27-30
	Reopen Nov. 29		(Close at Noon on the 27th—tentative)
			Reopen Fri. June 24

OCTOBER 1976

SUNDAY	MONDAY	TUESDAY	WEDNESDAY	THURSDAY	FRIDAY	SATURDAY
The self concept, we know, is learned. People learn who they are and what they are from the ways in which they have been treated by those who surround them in the process of their growing up. This is what Sullivan called learning about self from the mirror of other people. People discover their self concepts from the kinds of experiences they have had with life—not from telling, but from experience. People develop feelings that they are liked, wanted acceptable and able from being liked, wanted, accepted and from having been successful. One learns that he is these things, not from being told so but only through the experience of being treated as though they were so. —Arthur W. Combs					1	2
3	4 YOM KIPPUR SCHOOL CLOSED	5	6 PTA Ex. Bd. Mtg., Forest, 8:00 P.M.	7 PTA Ex. Bd. Mtg., Clear Stream, 9:30 A.M.	8 PTA Cultural Arts Assembly, Shaw 5th & 6th Gr. Bowling Begins, Forest	9 SUKKOT
10	11 COLUMBUS DAY CELEBRATED SCHOOL CLOSED	12 COLUMBUS DAY School Open C.H.S. Bd. of Ed. Mtg., 8:00 P.M.	13	14 Jelly Apple Sale, Clear Stream, 2:45 P.M.	15 Jelly Apple Sale, Clear Stream, 2:45 P.M.	16 SHEMINI ATZERETH
17	18 PTA Council Mtg., Howell, 8:00 P.M.	19	20 PTA Gen. Mtg., Shaw, 8:15 P.M.	21	22	23 PTA Children's Movie Forest
24	25 VETERANS DAY SCHOOL CLOSED	26 Dist. #30 Bd. of Ed. Mtg., 8:15 P.M.	27	28	29 5th & 6th Gr. Hallowe'en Party, Clear Stream, 7:30 P.M. 6th Gr. Hallowe'en Party, Forest, 7:30 P.M.	30
31						

SCHOOL ADMINISTRATION

Dr. William T. Callahan, *District Superintendent*
 Sherwood S. Quick
District Principal

SCHOOL PRINCIPALS

CLEAR STREAM AVENUE SCHOOL
 Richard M. Burbell

FOREST ROAD SCHOOL
 Maurice E. St. Mary

SHAW AVENUE SCHOOL
 Lawrence Cid

William J. Van Ness, *Administrative Assistant/Curriculum*
 George W. Niederhauser, *Administrative Assistant/Business*

SCHOOL SECRETARIES

Connie Deering, *Clear Stream Avenue*
 Mary McDowell, *Forest Road*
 Anna Docar, *Shaw Avenue*

DISTRICT SECRETARIAL STAFF

Margaret Bradley Mabel Hom Mary Ribando
 Annie O'Connell Gloria Zweier Jean Annona
 Della Schlaeger Edythe Sanchez

Evelyn Pearn, *Cafeteria Manager*

DISTRICT SPECIALISTS AND SPECIAL TEACHERS

Frank DeMarco, *Director of Educational Communications*
 Rosalyn Kessler, *Psychologist*
 Estelle Friedman, *Psychologist*
 Raydine Teicheira, *Speech Consultant*
 Robin Hananel, *Speech Teacher*
 Susan Wasserman, *Foreign Language Consultant*
 Henry Kohlmann, *Instrumental Music Teacher*
 Barbara Epstein, *Instrumental Music Teacher*
 Ellen Gordon, *Learning Disabilities Teacher*

OTHER SPECIALISTS AND SPECIAL TEACHERS

Clear Stream Avenue School

Rhoda Schachter, *Special Counselor*
 Jeanne Colton, *Reading Specialist*
 Grace Giacobone, *Art*
 Philip Hessemer, *Physical Education*
 Joan Henningsen, *Physical Education*
 Linda Pratt, *Music*
 Ruth Newman, *Library Media Specialist*
 Edna Giebel, *Nurse-Teacher*

Forest Road School

Helen Fink, *Special Counselor*
 Ada Keaney, *Reading Consultant*
 Eileen Goldsmith, *Art*
 Alfred Stevens, *Physical Education*
 Joan Henningsen, *Physical Education*
 Frances Gibson, *Music*
 Rose Agree, *Library Media Specialist*
 Hilda Rosenfeld, *Nurse-Teacher*

Shaw Avenue School

Verna Hearn, *Special Counselor*
 Janet Poppe, *Reading Specialist*
 Rosemary Williams, *Reading Teacher*
 Linda Muckle, *Art*
 Pamela Rein, *Art*
 Thomas Rouse, *Physical Education*
 Joan Stein, *Physical Education*
 Kathryn Egan, *Music*
 Barbara Briker, *Music*
 Sylvia Berkowitz, *Library Media Specialist*
 Eileen Corcoran, *Nurse*

NOVEMBER 1976

SUNDAY	MONDAY	TUESDAY	WEDNESDAY	THURSDAY	FRIDAY	SATURDAY
	1	2 ELECTION DAY SCHOOL CLOSED	3 PTA Ex. Bd. Mtg., Forest, 8:00 P.M.	4 PTA Ex. Bd. Mtg., Clear Stream, 9:30 A.M.	5	6 PTA Art Auction, Shaw, 7:30 P.M.
7	8 District 30 Open School Week Begins	9 C.H.S. Bd. of Ed. Mtg., 8:00 P.M.	10 Pre-School Mtg., Forest, 3:00 P.M.	11 VETERANS DAY (Traditional)	12	13 PTA Dance, Clear Stream at K. of C. Hall, 9:00 P.M.
14	15	16	17 PTA Ex. Bd. Mtg., Shaw, 1:00 P.M. PTA Gen. Mtg., Forest, 8:15 P.M.	18 Family-Faculty Sports Night & Gen. Mtg., Clear Stream, 7:30 P.M.	19	20
21 Report Cards Issued	22	23 Dist. #30 Bd. of Ed. Mtg., 8:15 P.M.	24 SCHOOL CLOSED	25 SCHOOL CLOSED THANKSGIVING VACATION	26 SCHOOL CLOSED	27
28 SCHOOL REOPENS	29	30	When a person is open to experience there is a maximum of adaptability, a discovery of structure in experience, a flowing, changing organism of self and personality. It means discovering the structure of experience in the process of living the experience.			

CLEAR STREAM AVENUE PARENT TEACHER ASSOCIATION

ELECTED OFFICERS 1976-1977

Co-President	Sue Farrell	872-8026
Co-President	Kay McDonald	825-3313
First Vice President	Lenore Vita	285-5394
Second Vice President	Marion Acquavella	825-2272
Treasurer	Mary Tragner	285-9502
Membership	Ann Prisco	285-5744
Recording Secretary	Rosemary Smith	561-8667
Corresponding Secretary	Eileen Calandrino	825-6470
Delegates to Council	Mary Maclean	Faculty
	Tommie Fonte	872-0148
	Fran Gentile	872-3206
Past Presidents	Dorothy Walz	872-8011
	Terry Keller	285-7016

COMMITTEE CHAIRMEN

Arts & Flyers	Sandy Henry	825-6572
Audio-Visual	Frank DeMarco	Faculty
Budget	Lenore Vita	285-5394
Cultural Arts	Linda Pratt	Faculty
Distribution	Terry Annaruma	285-7598
Health	Mary Ann Gokey	285-7358
Historian	Kay McDonald	825-3313
Human Relations	Arleen Ercole	285-8127
Juvenile Protection	Barbara McLaughlin	825-6162
Legislation	Dorothy Walz	825-8011
Pre-School	Marion Acquavella	825-2272
School and Community	Dorothy Walz	825-8011
Sunshine	Ann Prisco	285-5744
Streamer	Sandy Henry	825-6572
Ways and Means	Rosemary Smith	561-8667
Bowling President	Roseann Petruzillo	285-4795
Secretary	Evelyn MacGown	285-4712
Treasurer	Marie Grande	561-1848
Jr. Bowling Secretary	Phyllis Capitano	872-8313
Treasurer	Dorothy Walz	825-8011
Community Relations	Mrs. Louise Quinn	Faculty
Hospitality Chairman	Mrs. Rhoda Schacter	Faculty
	Rebecca Sheil	CU5-7779
Publicity	Amelia Pascoello	872-3119
Grade Rep. Chairman	Eileen Calandrino	825-6470
Kindergarten Grade Rep.	Terry Keller	285-7016
1st Grade Rep.	Marion Acquavella	825-2272
2nd Grade Rep.	Faith Breiner	285-9087
3rd Grade Rep.	Lenore Vita	285-5394
4th Grade Rep.	Ann Prisco	285-5744
5th Grade Rep.	Eileen Calandrino	825-6470
6th Grade Rep.	Barbara Parisi	825-3214
	Beverly Jablonowski	825-0994

P.T.A. PROGRAM

Sept.	9	Executive Board Meeting, 9:30 A.M.
	22	General Meeting and Parents' Night, 7:30 P.M. (K-3)
	23	General Meeting and Parents' Night, 7:30 P.M. (4-6)
Oct.	7	Executive Board Meeting, 9:30 A.M.
	14	Jelly Apple Sale, 2:45 P.M.
	15	Jelly Apple Sale, 2:45 P.M.
	29	5th and 6th Grade Halloween Party, 7:30 P.M.
Nov.	4	Executive Board Meeting, 9:30 A.M.
	13	Fall Dance at St. Theresa Knights of Columbus, 9:00 P.M.
	18	Family-Faculty Sports Night & Gen. Mtg., 7:30 P.M. (Gr. 4-6)
Dec.	2	Executive Board Meeting, 9:30 A.M.
	7	Pre-School Meeting, 1:30 P.M. (Parents of 4 year olds)
	16	Holiday Boutique, 2:45 P.M.
	17	Holiday Boutique, 2:45 P.M.
	23	Holiday Assembly, 1:30 P.M.
Jan.	6	Executive Board Meeting, 9:30 A.M.
	20	General Meeting, 8:00 P.M.
	24	Sex Hygiene Film for 5th and 6th Grade Parents, 7:30 P.M.
	25	Sex Hygiene Film for 6th Gr. children and Parents, 7:30 P.M.
	26	Sex Hygiene Rap Session for 6th Grade Children, 3:00 P.M.
Feb.	3	Executive Board Meeting, 9:30 A.M.
	11	Cake Sale, 2:45 P.M.
Mar.	3	Executive Board Meeting, 9:30 A.M.
	4	Father-Son and Daughter Night, 7:30 P.M.
	7	Pre-School Meeting, 1:30 P.M. (Parents of 4 year olds)
	22	Pre-School Meeting, 1:30 P.M. (Parents of 3 year olds)
	24	General Meeting, 8:00 P.M.
Apr.	14	Executive Board Meeting, 9:30 A.M.
	14	Cultural Arts Assembly, 1:30 P.M.
	16	Vision Screening, 9:00 A.M.
	28	Teachers' Recognition Day, 11:00 A.M.
May	5	Executive Board Meeting, 9:30 A.M.
	5	Hygiene Film for 4th Grade Girls, 3:00 P.M.
	5	Mothers' Day Boutique, 2:45 P.M.
	6	Mothers' Day Boutique, 2:45 P.M.
	19	Art Exhibit and Cake Sale, 7:30 P.M.
	26	General Meeting and Installation, 8:15 P.M.
June	2	Joint Executive Board Meeting, 9:30 A.M.

DECEMBER 1976

SUNDAY	MONDAY	TUESDAY	WEDNESDAY	THURSDAY	FRIDAY	SATURDAY
<p>knowing self must feel that it is involved, that it is part of what is going on, that in some degree it is shape its own destiny, together with the destiny. The self "looks out" upon the surrounding scene in terms of its own enhancement or defense.</p> <p style="text-align: right;">—Earl C. Kelley</p>	1	2	3	4	5	6
5	6	7	8	9	10	11
12	13	14	15	16	17	18
19	20	21	22	23	24	25
26	27	28	29	30	31	1
SCHOOL RECESS	CHRISTMAS RECESS SCHOOL CLOSED	CHRISTMAS RECESS SCHOOL CLOSED	CHRISTMAS RECESS SCHOOL CLOSED	CHRISTMAS RECESS SCHOOL CLOSED	NEW YEAR'S EVE SCHOOL CLOSED	

SHAW AND WASHINGTON AVENUES PARENT TEACHER ASSOCIATION

ELECTED OFFICERS 1976-1977

ident	Elaine Kelly	825-0113
t Vice President	Marianne Bono	285-6405
nd President	Grace Duffe	561-9291
su	Margaret Nugent	872-6378
ncial Secretary	Vera Manzo	872-8717
esponding Secretary	Grace Pisano	872-3097
rding Secretary	Elaine Mosca	825-0414
gates to Council	Miriam Sweet	Faculty
	Pamela Voloshin	285-8379
	Carol Blankshine	825-3119
	Diane Keenan	285-6068

COMMITTEE CHAIRMEN

io-Visual	Mr. J. Giacalone	Faculty
ling	Lillian Ging	285-6072
30wling	Judy Delgado	872-0817
et	Ethel Paone	285-7029
r	Claire Piemonte	825-8032
ural Arts & Programs	Marie Hutnick	872-8537
	Grace Duffe	561-9291
	Angela Maglione	825-7440
tribution	Jeanette Alloro	285-7269
rs	Angela Rodi	285-4951
e Rep. Coordinator	Cathy Barbara	285-8469
rian	Susan Castagnola	285-5290
itality	Pamela Voloshin	285-8379
ilation	Edwina Mateo	285-9795
bership	Camille Audino	285-6212
ograph	Ginny Waite	285-7955
es	Ethel Paone	285-7029
letter	Marie Verriello	285-5171
	Joanne Owens	872-0481
	Marcie Brown	285-5161
it Education	Lois Patranzino	285-5102
chool	Lucille Mazza	285-7926
icity	Elaine Mosca	825-0414
l Board Rep.	Karen O'Connell	285-7090
l-Community Relations	Margaret Nugent	872-6378
n Screening	Grace Pisano	872-3097
& Means	Marianne Bono	285-6405

Auction, Boutiques, Cupcake Sale, Sweat Shirt Sale, Fashion Show)

P.T.A. PROGRAM

Sept.	13	4th, 5th and 6th Grade Jr. Bowling Meeting, Shaw, 3:30 P.M.
	16	Parents' Night, Shaw (Grades 4-6), 8:15 P.M.
	20	Jr. Bowling Starts
	22	PTA Executive Board Meeting, Shaw, 1:00 P.M.
	23	Parents' Night, Shaw (Grades K-3), 8:15 P.M.
	28	Parents' Night, Washington, 8:15 P.M.
Oct.	1	Sweat Shirt Sale, Shaw & Washington
	8	Cultural Arts Assembly, Shaw
	20	PTA General Meeting, ("Communicating With Children"), Shaw, 8:15 P.M.
Nov.	6	Art Auction, Shaw, 7:30 P.M.
	17	PTA Executive Board Meeting, Shaw, 1:00 P.M.
Dec.	1	PTA General Meeting, Shaw, 8:15 P.M.
	3	Holiday Assembly, Shaw
	6	Pre-School Meeting, Shaw & Washington, 3:00 P.M.
	8	Holiday Boutique, Shaw & Washington
Jan.	12	Cup Cake Sale, Shaw & Washington
	19	PTA General Meeting, ("Cosmetology"), Shaw, 8:15 P.M.
Feb.	16	PTA Executive Board Meeting, Shaw, 1:00 P.M.
Mar.	10	Fashion Show, Valley Stream Park Inn, 8:00 P.M.
	14	Pre-School Meeting, Shaw & Washington, 3:00 P.M.
	16	PTA Executive Board Meeting, Shaw, 1:00 P.M.
	25	PTA Social Night, Shaw, 8:00 P.M.
Apr.	20	PTA Executive Board Meeting, Shaw, 1:00 P.M.
	23	Vision Screening, Shaw, A.M.
May	4	Mother's Day Boutique, Shaw & Washington
	11	Teacher's Recognition Day, Shaw
	16	Pre-School Meeting, Shaw & Washington, 3:00 P.M.
	19	PTA General Meeting, Installation, 8:00 P.M.
June	1	PTA Joint Board Meeting, Shaw, 1:00 P.M.
	13	PTA Volunteer's Meeting, Shaw, 10:00 A.M.
	15	Father's Day Boutique, Shaw & Washington

JANUARY 1977

SUNDAY	MONDAY	TUESDAY	WEDNESDAY	THURSDAY	FRIDAY	SATURDAY
						1 NEW YEAR'S DAY
2	3 SCHOOL REOPENS	4	5 PTA Ex. Bd. Mtg., Forest, 8:00 P.M.	6 PTA Ex. Bd. Mtg., Clear Stream, 9:30 A.M.	7	8
9	10	11 C.H.S. Bd. of Ed. Mtg., 8:00 P.M.	12 PTA Cupcake Sale, Shaw & Washington; Pre-School Mtg., Forest, 2:00 P.M.	13	14	15 PTA Children's Movie Forest
16	17	18	19 PTA Gen. Mtg., Shaw, 8:15 P.M. & Forest, 8:15 P.M.	20 PTA Gen. Mtg., Clear Stream, 8:00 P.M.	21	22
23 Family Living Pro gram, 5th & 6th Gr. Parents Clear Stream, 7:30 P.M.	24	25 Dist. #30 Bd. of Ed. Mtg., 8:15 P.M.; Family Living Program, 6th Gr. Pupils and Parents.	26	27 Family Living Rap Session, 6th Gr. Pupils, Clear Stream,	28	29
30	31					

FOREST ROAD PARENT TEACHER ASSOCIATION

ELECTED OFFICERS 1976-1977

<i>resident</i>	Lydia Rosen	791-5488
<i>1st Vice President</i>	Shelly Koval	791-1232
<i>2nd Vice President</i>	Judy Orloff	791-3820
<i>3rd Vice President</i>	Carol Mutterperl	791-1060
<i>4th Vice President</i>	Irene Bochner	791-6351
<i>Treasurer</i>	Marie Spiwak	791-3307
<i>Financial Secretary</i>	Abby Tedesco	791-2157
<i>Corresponding Secretary</i>	Felicia Katz	791-9501
<i>Recording Secretary</i>	Roz Scheidt	791-9468
<i>Delegates to Council</i>	Rhoda Levine	791-3148
	Ruth Bazil	791-8556
	Marie Briody	791-5817

COMMITTEE CHAIRMEN

<i>Assembly</i>	Sandy Alexander	825-3457
<i>Outing (children)</i>	Elaine Sandler	791-5765
<i>Budget</i>	Ruth Bazil	791-8556
<i>Class Mothers</i>	Audry Chason	791-8248
	Lenora Paletz	791-5274
<i>Cultural Arts</i>	Shirley Hopchick	791-2092
<i>Children's Theatre</i>	Marie Briody	791-5817
<i>Ecology</i>	Irene Bochner	791-6351
<i>Family Living</i>	Carol Mutterperl	791-1060
<i>Players</i>	Harriet Shulman	791-7437
	Carol Provanzano	825-5915
<i>Goodwill</i>	Dorothy Alperson	791-2284
<i>Hospitality</i>	Donna Lobell	791-4568
	Claudia Markowski	791-1017
	Barbara Tankel	791-4276
<i>Health & Safety</i>	Linda Zahn	791-4516
<i>Historian</i>	Trena Danels	791-1506
<i>Legislation</i>	Judy Blancher	791-2499
<i>Membership</i>	Abby Tedesco	791-2157
<i>Timeograph</i>	Joan Frichling	791-7663
	Anita Suriani	791-3960
<i>Newsletter</i>	Sima Pomerantz	791-4019
<i>Circulation</i>	Felicia Katz	791-9501
<i>Parliamentarian</i>	Paulette Kirschenbaum	791-7045
<i>Posters</i>	Prudy Lotierzo	791-1381
<i>Pre-School</i>	Rhoda Levine	791-3148
<i>Program Chairman</i>	Judy Orloff	791-3820
<i>School Bd. Rep.—Elem.</i>	Marcia Langbart	791-8442
<i>School Bd. Rep.—High</i>		
<i>Teacher's Rep.</i>		
<i>Typist</i>	Christine Murray	
<i>Trays & Means</i>	Donna Lobell	791-4568
<i>Boutique</i>		
	Pat Block	791-4920
	Rhoda Blaustein	791-6475

Children's Movie

Sandy Train 791-8221
Evelyn Grabois 791-1604
Marilyn Sparber 791-6838

Book Fair

P.T.A. PROGRAM

Sept.	22	Meet the Teacher Night, 8:15 P.M.
Oct.	6	Executive Board Meeting, 8:00 P.M.
	8	5th and 6th grade bowling begins
	23	Children's Movie
	29	6th grade Halloween Party
Nov.	3	Executive Board Meeting, 8:00 P.M.
	10	Pre-School Meeting, 3:00 P.M.
	17	General Meeting, 8:15 P.M.
Dec.	1	Executive Board Meeting, 8:00 P.M.
	8	Holiday Boutique, 2:45 P.M.
	9	Pre-School Meeting, 2:00 P.M.
	11	Children's Movie
Jan.	5	Executive Board Meeting, 8:00 P.M.
	12	Pre-School Meeting, 2:00 P.M.
	15	Children's Movie
	19	General Meeting, 8:15 P.M.
Feb.	2	Executive Board Meeting, 8:00 P.M.
	9	Founders' Day Meeting, 8:30 P.M.
	17	Pre-School Meeting, 3:00 P.M.
Mar.	2	Executive Board Meeting, 8:00 P.M.
	12	Children's Movie
	16	Pre-School Meeting, 2:00 P.M.
	18	Book Fair
	21	Family Living Program, Parents, grades 4, 5, & 6, 8:00 P.M.
	22	Family Living Program, 5th grade boys and girls, 2:45 P.M.
	23	General Meeting, 8:15 P.M.
	24	Family Living Program, 6th grade girls & mothers, 7:00 P.M.
		Family Living Program, 6th grade boys & fathers, 8:30 P.M.
Apr.	13	Executive Board Meeting, 8:00 P.M.
	14	Pre-School Meeting, 3:00 P.M.
	16	Vision Screening
May	4	Executive Board Meeting, 8:00 P.M.
	12	Teacher's Recognition Luncheon, 11:30 A.M.
	18	General Meeting and Installation, 8:15 P.M.
June	1	Joint Executive Board Meeting, 8:00 P.M.
	8	Father's Day Boutique

FEBRUARY 1977

DAY	MONDAY	TUESDAY	WEDNESDAY	THURSDAY	FRIDAY	SATURDAY
	the fearful person withdraws his psychological shell, the self less adequate and the whole loses its ability to do, to venturate. —Earl C. Kelley	1	2	3	4	5
			PTA Ex. Bd. Mtg., Forest, 8:00 P.M.	PTA Ex. Bd. Mtg., Clear Stream, 9:30 A.M.		
6	7	8	9	10	11	12
	PTA Council Mtg., Clear Stream, 8:00 P.M.	C.H.S. Bd. of Ed. Mtg., 8:00 P.M.	Report Cards Issued PTA Founders' Day Meeting, Forest, All Schools, 8:30 P.M.		PTA Cake Sale, Clear Stream, 2:45 P.M.	LINCOLN'S BIRTHDAY
13	14	15	16	17	18	19
		Dist. #30 Bd. of Ed. Mtg., 8:15 P.M.	PTA Ex. Bd. Mtg., Shaw, 1:00 P.M.	Pre-School Mtg., Forest, 3:00 P.M.		
20	21	22	23	24	25	26
RECESS	WINTER RECESS SCHOOL CLOSED	WINTER RECESS SCHOOL CLOSED WASHINGTON'S BIRTHDAY	WINTER RECESS SCHOOL CLOSED	WINTER RECESS SCHOOL CLOSED	WINTER RECESS SCHOOL CLOSED	
27	28	SCHOOL REOPENS				
Time and again in my clients, I have seen simple people become significant and creative themselves, as they have developed more trust of the processes going on within within and express their own feelings, live by values which they discover						

CHILDREN AND LEARNING

You will note, from the article on Page 12, as well as the quotations throughout, that the theme for this year's calendar, is children and learning.

Because of the great pressures of modern society many of us are apt to forget that schools are there to educate the young. By "educate" we are referring not only to the 3 R's but to what many consider as frills—the cultural arts of music, art, and physical education, as well as social skills—the latter may well be the "stuff" of life.

We are dismayed when we are exposed to parents who are constantly pressuring youngsters to exceed the output of their peers—in school marks, or athletics, or any other endeavor in which they may be engaged. We all want them to succeed but wouldn't it be better to let them set their own goals? Encouragement can always be given them but there is a difference between encouragement and pressure.

Researchers have known for years that girls mature earlier than boys and that the boys will eventually catch up, yet many of us refuse to accept this fact and continue to expect the 5, 6, 7, and 8 year old boys to achieve as well as girls of the same age.

Dr. Ilg, of the famous Gesell Institute, says, "School pressure on a child should be his own growth pressure. A child in the right grade is his own pressure point."

As further evidence that growth rates differ, research has shown that teething is related to school performance. Most boys and girls, whose replacement of baby teeth was ahead of schedule, did well in class. By contrast, those whose second teeth were slow in coming in, tended to do less well.

All of us have witnessed the difference in children's growth in families where there is more than one child. John maybe learned to ride a two-wheel bicycle at 7 years of age but Robert, his brother, couldn't do it until 8 years of age. Most of us accept this. Cannot we see that this difference may also apply when John begins to read well at an earlier age than Robert?

Growth patterns do differ. It is well for all of us, parent as well as educator, to keep this in mind when we are dealing with children's learning.

There is another very important matter that should concern all of us and that is the development in all children of a good self-image.

Earl C. Kelley, in exploring why some people do not like their selves, says, "Damage to the self, so disabling to so many of us, comes from the fact that we grow up in an authoritarian culture. While it is true this is a democracy in governmental form, we have not achieved democracy in the home, the school or the church. The fact that we have a democratically chosen president or governor has no effect upon the developing child. He is built by the people close to him, and he does not elect them. The people close to him, having themselves been crippled, know no better than to continue the process."

He goes on to say that evils of authoritaria: are more

extensive than is ordinarily understood and that small tyrants do more harm than grand ones because they operate "on the growing edge of the personality of the young." Included are the parent, teacher, and church who in their own authoritarian way continue the process of making him think less of himself.

One's perceptions govern how a person develops. As Kelley says, "One of the most revealing facts about perception is that it is selective." We don't see all that goes on around us. To see all would cause "pandemonium." Therefore, we choose that which the self feeds on. This is because choices are based on experience and unique purpose. Our background of experience determines our perception. We cannot see that which we have no experience to see.

"In perception, purpose operates automatically most of the time. And so, just as we do not eat everything, our psychological selves are particular as to what we feed on. What they take in has to suit their purposes . . ." (Kelley).

The small tyrants see the young as objects to be coerced and constantly corrected or manipulated. The "facilitating" person does the opposite. He trusts them and allows them the freedom to become involved, part of what is going on and they share in their own destiny.

Kelley says, "the lack of consultation and involvement is the cause of the continuing war between parents and children, between teachers and learners, between teacher and administrators. . . . When the person is part of something, then he becomes responsible."

According to Kelley, the fully functioning person:

1. Thinks well of himself
2. Thinks well of others
3. Sees his stake in others
4. Sees himself as part of the world of movement—in process of becoming
5. Holds human values.
6. Knows no other way to live except in keeping with his values.

What does all of this mean to us as parents and educators?

It means that we have to become "facilitating" persons and not tyrants. We have to trust and respect our children; to allow them to become involved and a part of what is happening about them and to allow them to be responsible for what they are and what they become. We need to lend encouragement and not discouragement by having too high standards and being over-ambitious for them. They will misbelieve only when they are discouraged and believe they cannot succeed by useful means. Plants need sunshine and water to grow. Encouragement works the same for children.

Much of the above is taken from the 1962 Yearbook "Perceiving Behaving Becoming" of the Association For Supervision and Curriculum Development, Washington, D.C. The calendar quotations are taken from the same source.

MARCH 1977

SUNDAY	MONDAY	TUESDAY	WEDNESDAY	THURSDAY	FRIDAY	SATURDAY
<p>is that creation is not something occurred long ago and is dead, but that it is now going on and that he is part of it.</p> <p>—Earl C. Kelley</p>		1	2	3	4	5
			PTA Ex. Bd. Mtg., Forest, 8:00 P.M.	"Lights On" PTA Program, Mem. JHS, 8:00 P.M.	PURIM; Father-Son-Daughter Night, Clear Stream, 7:30 P.M.	
6	7	8	9	10	11	12
	Pre-School Mtg., (Parents of 4 yr. olds), Clear Stream, 1:30 P.M.	C.H.S. Bd. of Ed. Mtg., 8:00 P.M.		PTA Fashion Show, Shaw, at Park Inn, 8:00 P.M.		PTA Children's Movie Forest
13	14	15	16	17	18	19
	Pre-School Mtg., Shaw & Washington, 3:00 P.M.		PTA Ex. Bd. Mtg., Shaw, 1:00 P.M. Pre-School Mtg., Forest, 2:00 P.M.	ST. PATRICK'S DAY	PTA Book Fair, Forest	
20	21	22	23	24	25	26
	Family Living Program, Grs. 4, 5 & 6, Forest, 8:00 P.M.	Dist. Bd. of Ed. Mtg., 8:15 P.M.; Pre-School Mtg., (Parents of 3 yr. olds), Clear Stream, 1:30 P.M.; Family Living Program, 5th Gr., Forest, 2:45 P.M.	PTA Gen. Mtg., Forest, 8:15 P.M.	PTA Gen. Mtg., Clear Stream, 8:00 P.M.; Family Living Program, 6th Gr. Girls—7:00 P.M. & 6th Gr. Boys—8:30 P.M. Forest	District Music Concert, Shaw, 8:15 P.M.	
27	28	29	30	31	A greater openness to experience offers many advantages. It provides	
			Public Hearing on			

PSYCHOLOGY AND CHILDREN'S LEARNING

The following is from a booklet, "What Psychology Can We Trust" by Goodwin Watson of Teachers College of Columbia University. It sums up in an incisive, lucid and terse fashion a great deal of psychological research which should prove of interest to parents as well as teachers.

- Behaviors which are rewarded (reinforced) are more likely to recur.

This most fundamental law of learning has been demonstrated in literally thousands of experiments. It seems to hold for every sort of animal from earthworms to highly intelligent adults. The behavior most likely to emerge in any situation is that which the subject found successful or satisfying previously in a similar situation. No other variable effects learning so powerfully. The best planned learning provides for a steady cumulative sequence of successful behaviors.

- Reward (reinforcement), to be most effective in learning, must follow almost immediately after the desired behavior and be clearly connected with the behavior in the mind of the learner.

The simple word, "Right," coming directly after a given response, will have more influence on learning than any big reward which comes much later on which is dimly connected with many responses so that it can't really reinforce any of them. Much of the effectiveness of programmed self-instruction (teaching machines) is that success is fed back immediately for each learner response. A total mark on a test, the day after it is administered, has little or no reinforcement value for the specific answers.

- Sheer repetition without indications of improvement or any kind of reinforcement (reward) is a poor way to attempt to learn.

Practice is not enough. The learner cannot improve by repeated efforts unless he is informed about how well each one has succeeded.

- Threat and punishment have variable and uncertain effects upon learning; they may make the punished response more likely or less likely to recur; they may set up avoidance tendencies which prevent further learning.

Punishment is not, psychologically, the reverse of reward. It disturbs the relationship of the learner to the situation and teacher. It does not assist the learner in finding and fixing the correct response.

- Readiness for any new learning is a complex product of interaction among such factors as (a) sufficient physiological and psychological maturity, (b) sense of the importance of the new learning for the learner in his world, (c) mastery of the prerequisites providing a fair chance of success, and (d) freedom from discouragement (expectation of failure) or threat (sense of danger).

Conversely, the learner will not be ready to try new responses which are beyond his powers or which are seen as valueless or too dangerous.

- Opportunity for fresh, novel, stimulating experience is a kind of reward which is quite effective in conditioning and learning.

Experiments indicate that even lower animals (rats, dogs, monkeys) will learn effectively when they receive rewards of new experience or satisfied curiosity, as they will when the rewards gratify desires for food, water, sex, or rest. One trouble with the typical school day is that it is too dull; pupils find too few stimulating insights to reward their efforts.

- Learners progress in any area of learning only as far as they need to in order to achieve their purposes. Often they only do well enough to "get by"; with increased motivation they improve.

One of the earliest psychological studies showed that telegraph operators with years of practice seldom rose in speed beyond the acceptable "main line" rate; they could, however, learn to send and receive much faster if special incentives were provided. Studies of reading speed show that practice alone will not bring improvements; a person may have read books for years at his customary rate, but with new demands and opportunities he may be able to double that rate.

- The most effective effort is put forth by children when they attempt tasks which fall in the "range of challenge"—not too easy and not too hard—where success seems quite possible but not certain.

A good illustration is the dart game. Where is it most fun to stand? So close that you can't miss? So far away that you can't make a decent score? The maximum fun is at the level of challenge. If it proves too easy, one steps further back; if it proves too hard one steps a little closer. It is not reasonable to expect a teacher to set an appropriate level of challenge for each pupil in class; pupils can, however, learn to set their own goals to bring maximum satisfaction and learning.

- Children are more apt to throw themselves wholeheartedly into any project if they themselves have participated in the selection and planning of the enterprise.

Genuine participation (not pretend sharing) has been found to increase motivation, adaptability, and speed of learning.

- Over-strict discipline is associated with conformity, anxiety, shyness, and acquiescence in children; greater permissiveness is associated with more initiative and creativity in children.

Comparison of children whose parents were at the most permissive extreme of home discipline with those who were most strict (both groups of parents loving and concerned) has shown more enterprise, self-confidence, curiosity, and originality in the youngsters from permissive homes. These children were also more friendly and less hostile than the strictly disciplined children. The demand for more restrictive discipline runs counter to the call for more individuality.

- Many pupils experience so much criticism, failure, and discouragement in school that their self-confidence, level of aspiration, and sense of worth are damaged.

The pupil who sees himself at his worst in school is likely to place little value on study and to seek his role of importance outside the classroom. He may carry through life a sense of being not good for much. He is likely also to feel resentment at schools, teachers and books.

APRIL 1977

DAY	MONDAY	TUESDAY	WEDNESDAY	THURSDAY	FRIDAY	SATURDAY
					1	2
					PTA Social Night, Shaw, 8:00 P.M.	
3	4	5	6	7	8	9
FIRST DAY OF PASSOVER SUNDAY	SECOND DAY OF PASSOVER EASTER RECESS SCHOOL CLOSED	EASTER RECESS SCHOOL CLOSED	EASTER RECESS SCHOOL CLOSED	HOLY THURSDAY EASTER RECESS SCHOOL CLOSED	GOOD FRIDAY EASTER RECESS SCHOOL CLOSED	
10	11	12	13	14	15	16
EIGHTH DAY OF PASSOVER SUNDAY	EIGHTH DAY OF PASSOVER EASTER RECESS SCHOOL CLOSED	SCHOOL REOPENS C.H.S. Bd. of Ed. Mtg., 8:00 P.M. PTA Scholarship Drive—All Week	PTA Ex. Bd. Mtg., Forest, 8:00 P.M.	PTA Ex. Bd. Mtg., Clear Stream, 9:30 A.M.; PTA Cultural Arts Assembly, Clear Stream, 1:30 P.M.; Pre-School Mtg., Forest, 3:00 P.M.		PTA Vision Screening, Clear Stream & Forest
17	18	19	20	21	22	23
	PTA Council Mtg., Willow, 8:00 P.M.		PTA Ex. Bd. Mtg., Shaw, 1:00 P.M.			PTA Vision Screening, Shaw
24	25	26	27	28	29	30
		Dist. #30 Bd. of Ed. Mtg.	Parent Cards Issued	Teacher Recognition Day, Clear Stream; Registration		

SCHOOL POLICIES

SCHOOL HOURS

hours for grades 1, 2, and 3 are from 9:00 a.m. to 3:00 p.m.
hours for grades 4, 5, and 6 are from 8:30 a.m. to 2:45 p.m.

LUNCH

Lunch is served beginning with the first day of school. Pupils go home for lunch, bring lunch from home, or buy the school lunch in the cafeteria for 50c. Monthly menus are provided so if foods are served which your child does not eat, you can get other provisions for him for those days. In case a child loses his lunch money or his lunch, or loses either, we have a charge system to cover the emergency. The cashier in the cafeteria keeps the record of such charges and contacts the parents if a charge not be paid in a reasonable time.

ICE CREAM

Ice cream is sold daily to those pupils who wish it. It is *not* included in the hot lunch and costs an additional 10c.

RECESS MILK

Recess milk is available to all children beginning about the first week of the school year and is sold at a cost of 40c per week. It is available each Thursday for the following week. You will be notified as to the exact date. Money brought in late (Friday) cannot be accepted. In case of a child's absence, no refund is made for periods of less than a full week.

ABSENCES

When your child has been absent, State law requires that he bring a note from you explaining the absences and the date(s) of absence(s). The note should be presented to the nurse *before* he goes to the classroom. Please be specific. Just saying, "he was sick" is not enough. Indicate whether it was "virus," "fever," "cold," etc. A note is required for an absence due to a religious day. A note is required for any tardiness, giving the reason. If your child contracts a contagious disease, such as mumps, measles, etc., please phone the school nurse so that she can contact the parents in your child's class that their children have been exposed. Be sure to keep the emergency card up to date and have it so you will know whom to call should your child come ill to school or have to go home.

NOON HOUR RULES

When pupils misbehave in the cafeteria, auditorium, or on the playground during the noon hour, after repeated reminders, the teachers have the authority to exclude them from staying in school for lunch for a few days, or longer, depending on the misbehavior. If you receive such a note from us, we would appreciate your cooperation. Whether or not a mother is home during the noon hour has no bearing on this exclusion.

RELEASED TIME FOR RELIGIOUS INSTRUCTION

A Release Form signed by the parent is necessary should you want your child excused from school for religious instruction. Such forms can be obtained from your church. The time provided is the last hour of school on Wednesday afternoons.

EXITS AND ENTRANCES

Your child's class is assigned a specific exit and entrance to use. You will thus know where to meet him if you come to pick him up. Parents picking up children are asked to meet them at the exit, *not the classroom*.

ENTRANCE TIMES

Morning — All Schools	Noontime — Shaw & Forest
Grades 1, 2, & 3 — 8:50	Grades 1, 2, & 3 — 12:50
Grades 4, 5, & 6 — 8:20	Grades 4, 5, & 6 — 12:20
Noontime — Clear Stream: Grades 5 & 6 — 12:05	
Grades 3 & 4 — 12:35; Grades 1 & 2 — 1:05	

Because there is no supervision of the playground in the morning, we suggest you arrange your child's departure from home to allow him to arrive just in time to enter the building during the proper interval. In inclement weather he may come into the designated area five minutes before the above times.

CLASS INTERRUPTIONS

No unnecessary interruptions of classes are allowed once the day's sessions have begun. When your child forgets a book, homework, sneakers, lunch money, etc., please bring these to the office. All pupils are instructed to check with the office at lunch time for such forgotten items. In the interest of the child's all-round education, we urge you not to make a practice of bringing forgotten items to school. The child should be developing his own sense of responsibility for these things.

MAY 1977

SUNDAY	MONDAY	TUESDAY	WEDNESDAY	THURSDAY	FRIDAY	SATURDAY
1	2	3 Art Exhibit, Forest, 7:30-9:00 P.M.	4 VOTING ON SCHOOL BUDGET, 7:00 A.M.-10:00 P.M.; PTA Mother's Day Boutique, Shaw & Washington; PTA Ex. Bd. Mtg., Forest, 8:00 P.M. Mother's Day Boutique, Forest, 2:45 P.M.	5 PTA Ex. Bd. Mtg., Clear Stream, 9:30 A.M. PTA Mother's Day Boutique, Clear Stream, 2:45 P.M.; Family Living Program, 4th Gr. Girls, Clear Stream, 3:00 P.M.	6 PTA Mother's Day Boutique, Clear Stream, 2:45 P.M.	7
8 MOTHER'S DAY	9	10 C.H.S. Bd. of Ed. Mtg., 8:00 P.M.	11 Teacher's Recognition Day, Shaw	12 Teacher's Recognition Day Luncheon, Forest	13	14
15	16 Pre-School Mtg., Shaw & Washington, 3:00 P.M.	17	18 PTA Installation Mtg., Forest, 8:15 P.M.	19 Art Exhibit, Clear Stream, 7:30-9:00 P.M. PTA Installation Mtg., Shaw, 8:00 P.M.; PTA Cake Sale, Clear Stream, 7:30 P.M.	20	21
22	23 SHAVUOTH	24 Dist. #30 Bd. of Ed. Mtg., 8:15 P.M.	25	26 Art Exhibit, Shaw, 7:30-9:00 P.M.; PTA Installation Mtg., Clear Stream, 8:15 P.M.	27	28
29	30 MEMORIAL DAY (FERIATED)	31 MEMORIAL DAY	When the fearful person withdraws within his psychological shell, communication is shut off. It is just as difficult for such a person to give as it is for him to receive. The self then is denied that which it feeds on. The psychological self feeds on ideas, which come from people. Without the stuff of growth, the self			

SCHOOL POLICIES

GYM SUITS AND SNEAKERS

Gym suits are required of pupils below the 3rd grade, but sneakers are necessary for any pupils using the gym. Boys and girls from the 3rd through 6th grades are required to wear gym suits and sneakers on the assigned gym days. The gym teachers explain this to the pupils, but many times they do not bring correct information home.

Who MUST PURCHASE A NEW SUIT should buy the correct ROYAL BLUE, bloomer type, with elastic bottoms, or ROYAL BLUE shorts with elastic insert in the cuff, and a white shirt. Boys should wear ROYAL BLUE shorts, with elastic top, and sneakers (high top ones preferred), and white or SCHOOL "T" shoes.

IF A CHILD HAS ANOTHER COLOR, OR TYPE, HE DOES NOT NEED TO BUY A NEW ONE. The above apparel may be purchased at many local stores in Valley Stream. NO ONE IS ALLOWED ON THE GYM FLOOR WITHOUT SNEAKERS.

APPOINTMENTS WITH TEACHERS

Remember that pupils' classtime be used to the fullest advantage, and request that parents do not seek conferences with teachers during school hours. If you wish a conference, please make an appointment to see the teacher after school. Teachers are available for such conferences every day except Wednesdays and Fridays.

BICYCLES

Bicycles are allowed at either Forest Road or Clear Stream Elementary Schools because no child lives far enough from the school to make them necessary. They are allowed at Shaw, but are restricted to pupils in grades 4, 5, and 6 who live NORTH OF CLEAR AVENUE. Bicycles used to come to the Shaw Avenue School will be assigned a number. All must have a lock and a bell for safety purposes.

GIFTS TO TEACHERS PROHIBITED

Policy of the school district which became effective January 1, 1956, is to prohibit the acceptance of gifts by faculty members on school premises, and to prohibit the solicitation of funds for personal gifts purposes, by any person, or persons on the premises.

IN-DAY PROGRAM

In inclement weather, there is an in-day program of motion pictures provided for those pupils who eat in the cafeteria. Pupils who go home to lunch are not allowed to participate in this program because of space limitations, so we ask parents to return these pupils to school on such days just in time for the afternoon session—not before 12:50 p.m. for grades 1 to 3, and 12:20 p.m. for grades 4 to 6 at Shaw and Forest; and not before 12:05 for grades 5 and 6, 12:35 for grades 3 and 4, and 1:05 for grades 1 and 2 at Clear Stream.

HOMEWORK REQUIREMENTS

Homework is required of all pupils, but it will vary from day to day. First and second grade pupils may have fifteen to twenty minutes of homework per day, while third and fourth grade pupils are likely to have thirty to forty minutes. Fifth and sixth graders are expected to devote as much as an hour to homework, but again this may not be every day—it will depend on the pupil and his needs.

LOST AND FOUND

Unmarked articles lost by pupils are placed in the Lost-and-Found, which is in the Nurse's Office at Shaw & Forest, and the custodian's office at Clear Stream. Such articles, if not claimed at the end of the school year, are given to a charitable organization. However, any article bearing a child's name is returned directly to him. Please place your child's name on all his belongings.

STAYING AFTER SCHOOL

To eliminate any confusion or problems, the school may have your child every day for an additional half hour. During this half hour beyond the regular school day, the teacher may schedule your child for special help or keep him for any of several reasons. We ask that you keep this in mind and not schedule dental appointments, dancing lessons, etc. until after that interval. Teachers are also available to parents during the half hour after school, except on Wednesday and Friday, for conferences.

ASSEMBLIES

When your child's class puts on the assembly, we welcome your attendance, but we do ask you not to bring pre-school children. As much as we realize that it is a thrill for them to see a big brother perform, they are often distracting to all concerned. Picture taking is not allowed without prior approval.

JUNE 1977

SUNDAY	MONDAY	TUESDAY	WEDNESDAY	THURSDAY	FRIDAY	SATURDAY
			1 PTA Joint Ex. Bd. Mtg., Shaw—1:00 P.M. & Forest, 8:00 P.M.	2 PTA Joint Bd. Mtg., Clear Stream, 9:30 A.M.	3	4
5	6 PTA Council Mtg., North, 8:00 P.M. String Festival, Shaw, 7:30 P.M.	7 String Festival, Clear Stream, 7:30 P.M.	8 String Festival, Forest, 7:30 P.M. Father's Day Boutique, Forest, 2:45 P.M.	9	10	11
12	13 Volunteer's Mtg., Shaw, 10:00 A.M.	14 C.H.S. Bd. of Ed. Mtg., 8:00 P.M.	15 Father's Day Boutique, Shaw & Washington	16	17	18
19 MOTHER'S DAY	20	21	22 Closing Exercises for 6th Grade	23	24 LAST DAY OF SCHOOL	25
26	27	28 Dist. #30	29	30	The feeling of oneness with one's fellows produces in the truly adequate person a high degree of responsible,	

SHAW AND WASHINGTON AVENUE SCHOOLS

CLASS MOTHER LIST

Class Mother Chairman Cathy Barbara, 285-8469

Room	Class Mother	Tel. Number	Teacher
Kindergarten Representative JoAnn Iglie, 285-6458			
301 AM	Mrs. Iglie	285-6458	Mrs. Dankoff
302 PM	Mrs. Chiano	285-7721	Mrs. Dankoff
101 AM	Mrs. Balducci	872-0173	Miss Blessinger
101 PM	Mrs. Blankshire	825-3119	Miss Blessinger
102 PM	Mrs. Quinn	872-8858	Miss Starler
1st Grade Representative Anne Bochichio, 285-7865			
302	Mrs. Voloshin	285-8379	Mrs. Hartman
303	Mrs. Bochichio	285-7865	Mrs. Lazar
103	Mrs. O'Connell	285-7090	Mrs. Levine
105	Mrs. Brown	285-5161	Mrs. Graffigino
106	Mrs. Ruggiero	872-8980	
2nd Grade Representative Ginny Waite, 285-7955			
126	Mrs. Mosca	825-0414	Miss Shapiro
128	Mrs. Messina	285-9333	Miss Harrington
130	Mrs. Rodi	285-4951	Miss Cohen
3rd Grade Representative Barbara Baumgardner, 872-9241			
104	Mrs. Manzo	872-8717	Mrs. Sweet
07	Mrs. Owens	872-0481	Mrs. Strumpf
32	Mrs. Verriello	285-5171	Mrs. Stevens
33	Mrs. Daly	285-4836	
35	Mrs. Viggiano	872-0980	Mrs. Federici

Gr.	Room	Class Mother	Tel. Number	Teacher
4th Grade Representative Athena Mountanos, 561-2148				
4	108	Mrs. Duffe	561-9291	Mr. Carr
4	109	Mrs. Audino	285-6212	Mrs. Benedetto
4	110	Mrs. Montana	561-0267	Mr. Riccobono
4	114	Mrs. Cecere	285-5579	
5th Grade Representative Kathy Rosenbaum, 285-5059				
5	116	Mrs. Panarelli	825-7773	Miss Melzer
5	118	Mrs. Maglione	825-7440	Mrs. Hamcke
5	121	Mrs. Vecchione	825-7604	Mrs. Seid
5	122	Mrs. Mazzeo	285-5355	Mr. Beyer
6th Grade Representative Marge Lynch, 872-3887				
6	123	Mrs. Alloro	285-7269	Miss Lanell
6	124	Mrs. Patranzino	285-5102	Mrs. Sherman
6	125	Mrs. Amerouso	825-0959	Mrs. Haydock
6	127	Mrs. Mazza	285-7926	Mr. Giacalone
Special				
CL		Mrs. Hofmann	825-3870	Mrs. Lewis

JULY 1977

NDAY	MONDAY	TUESDAY	WEDNESDAY	THURSDAY	FRIDAY	SATURDAY	
the fully functioning person develops and holds human values . . . the better the life, the better the values. He knows no other way except in keeping with his values. —Earl C. Kelley						1	2
We need a validated, usable system of human values that we can believe in and devote ourselves to (to be willing to die for), because they are true rather than because we are exhorted to "believe and have faith." —A. H. Maslow							
3	4	5	6	7	8	9	
	INDEPENDENCE DAY	Dist. #30 Bd. of Ed. Reorganization Mtg., 8:15 P.M.					
10	11	12	13	14	15	16	
		C.H.S. Bd. of Ed. Mtg., 8:00 P.M.					
17	18	19	20	21	22	23	
24	25	26	27	28	29	30	
31		Dist. #30 Bd. of Ed. Mtg., 8:15 P.M.					

CLEAR STREAM AVENUE SCHOOL

CLASS MOTHER LIST

Class Mother Chairman
Terry Keller, 285-7016

Grade	Room	Class Mother	Tel. Number	Teacher
K AM	9	Delia Carrillo	285-4687	Andrea Eden
K AM	9	Karen Fox	825-0105	Andrea Eden
K AM	9	Cathy Lane	561-6548	Andrea Eden
K AM	9	Barbara Verga	872-0233	Andrea Eden
K PM	9	Carolyn Biscardi	825-6413	Andrea Eden
K PM	9	Sandy Henry	825-6872	Andrea Eden
K PM	9	Margaret Rollo	825-0929	Andrea Eden
K PM	9	Jean Sivillo	825-6003	Andrea Eden
K PM	8	Lee Egan	825-8975	Gail Starler
K PM	8	Nancy Jacob	872-0163	Gail Starler
K PM	8	Marie Trimboli	285-9023	Gail Starler
K PM	8	Marilyn Wong	872-6552	Gail Starler
1	A	Faith Breiner	285-9087	Mary Maclean
1	A	Kathryn Nelson	CU 5-7648	Mary Maclean
1	A	Maureen Richford	825-6518	Mary Maclean
1	A	Marilyn Schneider	825-5350	Mary Maclean
1	B	Theresa Benedetto	285-5410	Dorothy Schaaf
1	B	Eileen Calandrino	825-6470	Dorothy Schaaf
1	B	Carolyn Leggio	285-6222	Dorothy Schaaf
1	B	Florencia Volpe	872-3517	Dorothy Schaaf
1	7	Ann Aglio	872-3926	Pamela Lauria
1	7	Karen Baxt	872-8448	Pamela Lauria
1	7	Myrna Leon	872-0814	Pamela Lauria
1	7	Carmela Traina	CU 5-6156	Pamela Lauria
2	3	Kathy Cardalena	825-5431	Mary Ruschin
2	3	Carol Esturo	285-9125	Mary Ruschin
2	3	Mary Lynch	825-6490	Mary Ruschin
2	3	Carol Moon	285-4881	Mary Ruschin
2	5	Sheila Aja	872-3750	Virginia Galati
2	5	Terry Falco	872-0842	Virginia Galati
2	5	Joan Hollywood	285-6719	Virginia Galati
2	5	Gerry Sullivan	561-8694	Virginia Galati
2	6	Mary Frost	561-0889	Lillian Guberman
2	6	Jean Geist	872-6446	Lillian Guberman
2	6	Connie Magrino	285-7837	Lillian Guberman
2	6	Joanne Santoro	285-8905	Lillian Guberman
3	1	Joan Bauer	285-5049	Karen Firpo
3	1	Lucille Bertorello	872-3577	Karen Firpo
3	1	Connie Canicatti	872-0899	Karen Firpo
3	1	Winnie Eulmer	285-7372	Karen Firpo
3	2	Barbara Berton	825-8629	Dale Schindelmann
3	2	Margie Eichler	872-8133	Dale Schindelmann
3	2	Rosemary Smith	561-8667	Dale Schindelmann
3	2	Glady's Sollitto	VA 5-3865	Dale Schindelmann
3	4	Kay Pesce	285-5178	Louise Quinn
3	4	Roseann Petruzillo	285-4795	Louise Quinn
3	4	Ann Frisco	CU 5-5744	Louise Quinn
3	4	Maureen Tkacsik	285-5582	Louise Quinn
4	23	Joanne Esposito	285-6815	Barbara Nancken
4	23	Cheryl Holton	562-9055	Barbara Nancken
4	23	Terry Keller	285-7016	Barbara Nancken
4	23	Marie Presti	285-9034	Barbara Nancken
4	24	Bernice Castello	561-0241	Helen Inwald
4	24	Fran Esposito	285-9438	Helen Inwald
4	24	Julie Fiorentino	285-9328	Helen Inwald
4	24	Amelia Pascoello	872-3119	Helen Inwald
5	25	Fran Carnival	872-0433	Gerard Camilleri
5	25	Ann Finazzo	285-6660	Gerard Camilleri
5	25	Roseann Potter	872-9337	Gerard Camilleri
5	25	Lorraine Russo	872-6377	Gerard Camilleri
5	28	Marie Cimino	285-4933	Marie Gerdyk
5	28	Sue Farrell	872-8026	Marie Gerdyk
5	28	Emily Giganti	285-8432	Marie Gerdyk

5	28	Stella Rusinyak	285-8094	Marie Gerdyk
6	21	Phyllis Capitano	872-8313	David Cooper
6	21	Joanne LaBarbera	285-9820	David Cooper
6	21	Marilyn Palazzo	872-3372	David Cooper
6	21	Dorothy Walz	825-8011	David Cooper
6	22	Fran Cimiglio	285-7986	Edith Perinchief
6	22	Marie Grande	LO 1-1848	Edith Perinchief
6	22	Doris Pritchard	CU 5-8639	Edith Perinchief
6	22	Regina Schneider	872-8409	Edith Perinchief
6	27	Marge Croak	825-9352	Ellen Totten
6	27	Arleen Ercole	285-8127	Ellen Totten
6	27	Maryann Gokey	285-7358	Ellen Totten
6	27	Marilyn Kelly	285-4955	Ellen Totten

FOREST ROAD SCHOOL

CLASS MOTHER LIST

Class Mother Chairmen

Audrey Chason, 791-8248 and Lenora Paletz, 791-5274

Grade	Room	Class Mother	Tel. Number	Teacher
K	201	Eileen Rosenthal	791-5078	Mrs. Murray
K	201	Florence Thebner	791-1608	Mrs. Murray
*K	201	Sima Pomerantz	791-4019	Mrs. Murray
1	203	Rhoda Levine	791-3148	Mrs. Kessler
1	203	Felicia Katz	791-9501	Mrs. Kessler
1	203	Louise Wenzel	791-6354	Mrs. Kessler
1	204	Shirley Hopchick	791-2082	Mrs. Kalhofer
1	204	Claudia Markowski	791-1017	Mrs. Kalhofer
2	205	Eileen Gang	825-0668	Miss Perrich
2	205	Rita Kaplan	791-1695	Miss Perrich
*2	205	Lenora Paletz	791-5274	Miss Perrich
2	205	Mary Eisenstein	791-8029	Miss Perrich
2	206	Alice Fischer	791-3824	Miss Post
2	206	Patricia Block	791-4920	Miss Post
2	206	Abby Tedesco	791-2157	Miss Post
3	207	Claire Gendelman	791-5811	Mrs. Cummings
3	207	Gloria Slavin	791-7779	Mrs. Cummings
*3	209	Roz Scheidt	791-9468	Miss Clarke
3	209	Joan Frischling	791-7663	Miss Clarke
4	210	Joan Fishbein	872-3679	Mrs. Cabral
*4	210	Paulette Kirschenbaum	791-7045	Mrs. Cabral
4	210	Joyce Sprung	791-9122	Mrs. Cabral
4	211	Barbara Tankel	791-4276	Mr. Lesser
4	211	Gloria Masone	LO 1-7764	Mr. Lesser
4	211	Laura Hans	791-1764	Mr. Lesser
5	215	Beth Greenwald	791-7509	Miss Schwartz
5	215	Harriet Drucker	791-6452	Miss Schwartz
*5	215	Barbara Spetalnick	791-3989	Miss Schwartz
5	215	Sheila Boritz	791-9686	Miss Schwartz
5	218	Barbara Smerling	791-2540	Mrs. Neuman
5	218	Linda Jones	791-5816	Mrs. Neuman
5	218	Dotti Singer	791-9631	Mrs. Neuman
5	218	Betty Fine	791-1806	Mrs. Neuman
6	217	Florence Goldberg	791-7746	Mrs. Melnick
6	217	Linda Zahn	791-4516	Mrs. Melnick
6	217	Anita Suriani	791-3960	Mrs. Melnick
6	217	Sandra Train	791-8221	Mrs. Melnick
6	217	Evelyn Grabois	791-1604	Mrs. Melnick
6	217	Marie Briody	791-5817	Mrs. Melnick
6	217	Marion Lowenbraun	791-3980	Mrs. Melnick
6	217	Stella Behar	791-5854	Mrs. Melnick
6	220	Audrey Chason	791-8248	Mr. Kaufmann
6	220	Rhoda Blaustein	791-6475	Mr. Kaufmann
6	220	Phyllis Finkle	791-2568	Mr. Kaufmann
6	220	Joyce Miller	791-4952	Mr. Kaufmann
*6	220	Judy Orloff	791-3820	Mr. Kaufmann
6	220	Betty Sabbatini	791-8165	Mr. Kaufmann

*Grade Co-Ordinator

AUGUST 1977

SUNDAY	MONDAY	TUESDAY	WEDNESDAY	THURSDAY	FRIDAY	SATURDAY
	1	2	3	4	5	6
7	8	9	10	11	12	13
		C.H.S. Bd. of Ed. Mtg., 8:00 P.M.				
14	15	16	17	18	19	20
21	22	23	24	25	26	27
		Dist. #30 Bd. of Ed. Mtg., 8:15 P.M.				
28	29	30	31	It is necessary, in order for children to grow well, that adults have enough trust in them and in the natural processes of growth . . . to let them grow and help them in a taoistic rather than an authoritarian way.		

VALLEY STREAM SCHOOL DISTRICT No. 30 AND
 VALLEY STREAM HIGH SCHOOL
 VALLEY STREAM, NEW YORK

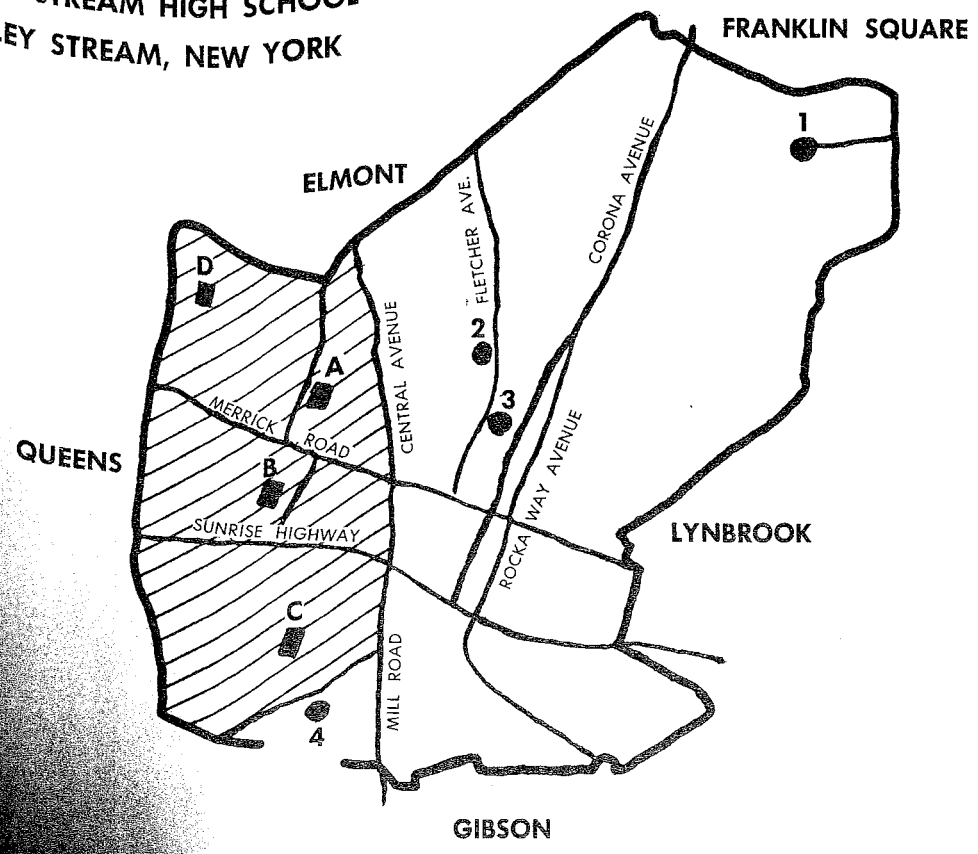

DISTRICT No. 30 SCHOOLS

- Shaw Avenue A
- Clear Stream Avenue B
- Forest Road C
- Washington Avenue D

Shaded Area — District 30

HIGH SCHOOLS

- North High 1
- Memorial Junior 2
- Central High 3
- South High 4

TELEPHONE DIRECTORY

5-9131	Shaw Avenue School	
5-9131	Principal's Office	VA 5-9131
5-9131	Nurse's Office	VA 5-9131
5-3044	Washington Avenue School	
5-3044	Office	VA 5-9131
1-7676	Special Services	
1-7676	Administrative Assistant/Curriculum	VA 5-9131
	Psychologist	VA 5-9131
	Speech Consultant	VA 5-9131
	Reading Consultant	PY 1-7676
	Audio-Visual Consultant	LO 1-1165

INDEX

Board of Education and School Calendar see October

Administration and Special Services see November

Clear Stream PTA see December

Shaw and Washington Ave. PTA see January

Forest Road PTA see February

Children & Learning see March

Psychology & Children's Learning see April

School Policies see May and June

Shaw and Washington Class Mothers see July

Clear Stream and Forest Class Mothers see August

Map of the District see facing page

VALLEY STREAM HIGH SCHOOL
 Telephone Number: 824-2073
 Use this number for all high school buildings, offices and personnel

NOTES

VALLEY STREAM UNION FREE SCHOOL
DISTRICT THIRTY

SCHOOL ACTIVITIES

Calendar

FOR 1976-1977

PUBLISHED BY THE BOARD OF EDUCATION

AND PARENT-TEACHER ASSOCIATIONS

VALLEY STREAM LION FREE SCHOOL
DISTRICT THIRTY

30

SCHOOL ACTIVITIES

Calendar

FOR 1977 - 1978

PUBLISHED BY THE BOARD OF EDUCATION AND PARENT-TEACHER ASSOCIATIONS

TELEPHONE DIRECTORY

INDEX

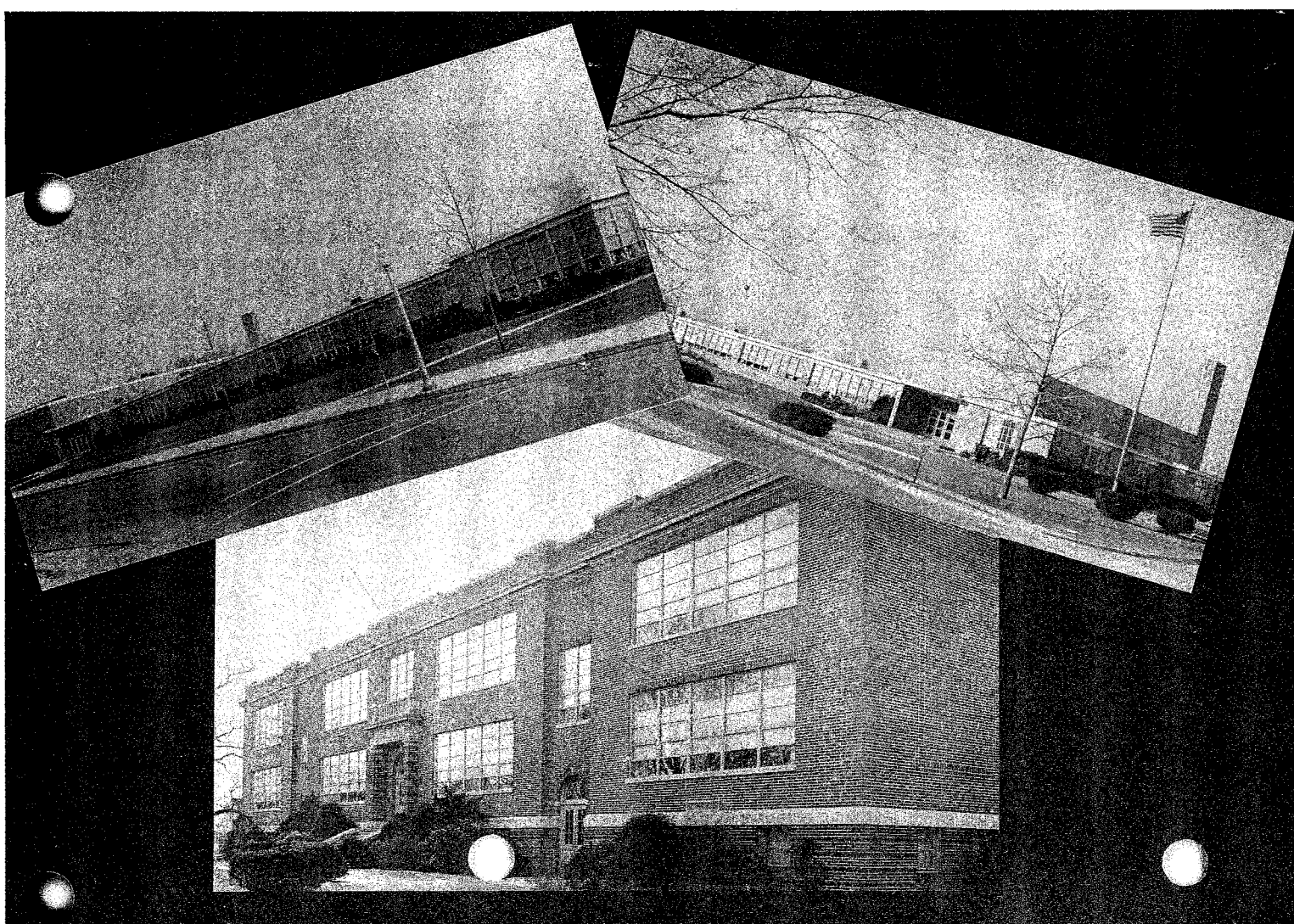

SEPTEMBER 1977

SUNDAY	MONDAY	TUESDAY	WEDNESDAY	THURSDAY	FRIDAY	SATURDAY
<p>The society which scorns excellence in plumbing because plumbing is a humble activity, and tolerates shoddiness in philosophy because it is an exalted activity, will have neither good plumbing nor good philosophy. Neither its pipes nor its theories will hold water.</p> <p style="text-align: right;">—John Gardiner</p>				1	2	3
4	5 LABOR DAY	6 Faculty Meeting	7 SCHOOL OPENS	8 PTA Ex. Bd. Mtg., Clear Stream, 9:30 A.M.	9	10
11	12 Gr. 4, 5, & 6 Jr. Bowling Mtg., Shaw, 3:00 P.M.	13 ROSH HASHANAH SCHOOL CLOSED C.H.S. Bd. of Ed. Mtg., 8:00 P.M.	14 SCHOOL CLOSED	15 Parents' Night, Shaw, Gr. K-3, 8:15 P.M.; Shaw PTA Bowling Begins	16	17
18	19 Shaw Jr. Bowling Begins	20 PTA Bowling Begins, Clear Stream; PTA Gen Mtg., "Meet the Teacher Night" Forest, 8:15 P.M.	21 PTA Ex. Bd. Mtg., Shaw, 1:00 P.M.	22 YOM KIPPUR SCHOOL CLOSED	23	24
25	26	27 SUKKOTH Dist. No. 30 Bd. of Ed. Mtg., 8:15 P.M.; Parents' Night, Washington, 8:15 P.M.	28 PTA Gen. Mtg. & Parents' Night, Clear Stream, Gr. K-3, 7:30 P.M.	29 PTA Gen. Mtg. & Parents' Night, Clear Stream, Grs. 4-6, 7:30 P.M.; Parents' Night, Shaw, Grs. 4-6, 8:15 P.M.	30	

BOARD OF EDUCATION



Standing (left to right): Joseph M. Barry,* William J. Van Ness, District Principal; Stephen Bazil,* Charles E. Pearn; Seated: Eleanor Zeller, District Clerk; Elinor McAuliffe,* George Adams, School Attorney, Absent, Robert H. Bell† and Eleanor Berger, District Treasurer.
 *Also serves on the High School Board.
 †Also serves on the Nassau County Board of Cooperative Educational Services.

SCHOOL CALENDAR, 1977-78

Meeting	Tues., Sept. 6	Christmas Recess	Dec. 24 thru Jan. 2
Opens for Students	Wed., Sept. 7		Reopen on Tues., Jan 3
Yom Kippur	Tues. & Wed., Sept. 13 & 14	Winter Recess	Feb. 20 thru Feb. 24
Rosh Hashanah	Thurs., Sept. 22		Reopen on Mon., Feb. 27
Thanksgiving Day	Mon., Oct. 10	Easter Recess	Mar. 24 thru Mar. 31
Teachers' Day	Fri., Nov. 11		Reopen on Mon., Apr. 3
Thanksgiving Recess	Nov. 23 thru Nov. 27	Memorial Day	Tues., May 30
	Close Noon Nov. 23—Reopen on Mon. Nov. 28	Last Day of School	June 2

OCTOBER 1977

SUNDAY	MONDAY	TUESDAY	WEDNESDAY	THURSDAY	FRIDAY	SATURDAY
						1
2	3 PTA Council Mtg., Willow Road	4 SHEMINI ATZERET	5 PTA Ex. Bd. Mtg., Forest, 8:00 P.M.	6 PTA Ex. Bd. Mtg., Clear Stream, 9:30 A.M.	7 PTA Sweat Shirt Sale, Shaw & Washington; 5th & 6th Gr. Bowling Begins, Forest	8 PTA Flea Market, Shaw
9	10 COLUMBUS DAY SCHOOL CLOSED	11 C.H.S. Bd. of Ed. Mtg. 8:00 P.M.	12 PTA Ex. Bd. Mtg., Shaw, 1:00 P.M.	13 Jelly Apple Sale, Clear Stream, 2:45 p.m.	14 Jelly Apple Sale, Clear Stream, 2:45 P.M.; PTA Cultural Arts Assembly, Shaw	15
16	17	18 PTA Gen Mtg., Forest, 8:15 P.M.	19	20	21 PTA Social Night, Shaw, 8:00 P.M.	22
23	24	25 Dist. No. 30	26	27	28 5th & 6th Gr. Hallowe'en Party, Clear Stream, 7:30 P.M.; 6th Gr.	29

SCHOOL ADMINISTRATION

Dr. William T. Callahan, *District Superintendent*

William J. Van Ness
District Principal

SCHOOL PRINCIPALS

CLEAR STREAM AVENUE SCHOOL
Richard M. Burbell

FOREST ROAD SCHOOL
Maurice E. St. Mary

SHAW AVENUE SCHOOL
Lawrence Cid

George W. Niederhauser, *Administrative Assistant/Business*

SCHOOL SECRETARIES

Connie Deering, *Clear Stream Avenue*
Stella Schlaeger, *Forest Road*
Anna Docar, *Shaw Avenue*

DISTRICT SECRETARIAL STAFF

Margaret Bradley Mabel Hom Mary Ribando
Jean Annona Gloria Zweier

Evelyn Pearn, *Cafeteria Manager*

DISTRICT SPECIALISTS AND SPECIAL TEACHERS

Frank DeMarco, *Director of Educational Communications*
Rosalyn Kessler, *Psychologist*
Estelle Friedman, *Psychologist*
Sharon Schulman, *Speech Consultant*
Robin Hananel, *Speech Teacher*
Susan Wasserman, *Foreign Language Consultant*
Henry Kohlmann, *Instrumental Music Teacher*
Barbara Wieder, *Instrumental Music Teacher*
Ellen Gordon, *Learning Disabilities Teacher*

OTHER SPECIALISTS AND SPECIAL TEACHERS

Clear Stream Avenue School
Rhoda Schachter, *Special Counselor*
Jeanne Colton, *Reading Specialist*
Grace Giacobone, *Art*
Philip Hessemer, *Physical Education*
Joan Henningsen, *Physical Education*
Linda Pratt, *Music*
Ruth Newman, *Library Media Specialist*
Jane Fitz-simons, *Nurse*

Forest Road School
Helen Fink, *Special Counselor*
Ada Keaney, *Reading Consultant*
Eileen Goldsmith, *Art*
Alfred Stevens, *Physical Education*
Joan Henningsen, *Physical Education*
Frances Gibson, *Music*
Anita Strelisker, *Library Media Specialist*
Hilda Rosenfeld, *Nurse-Teacher*

Shaw Avenue School
Noel Giambalvo, *Special Counselor*
Janet Poppe, *Reading Specialist*
Rosemary Williams, *Reading Teacher*
Linda Muckle, *Art*
Pamela Rein, *Art*
Thomas Rouse, *Physical Education*
Joan Stein, *Physical Education*
Kathryn Egan, *Music*
Barbara Briker, *Music*
Sylvia Berkowitz, *Library Media Specialist*
Eileen Corcoran, *Nurse*

NOVEMBER 1977

SUNDAY	MONDAY	TUESDAY	WEDNESDAY	THURSDAY	FRIDAY	SATURDAY
uses me each day consciously to have the worth sees in me.	—Unknown	1	2 PTA Ex. Bd. Mtg., Forest, 8:00 P.M.	3 PTA Ex. Bd. Mtg., Clear Stream, 9:30 A.M.	4	5
6	7	8 ELECTION DAY SCHOOL IS OPEN C.H.S. Bd. of Ed. Mtg., 8:00 P.M.; PTA Cake Sale, Forest	9 PTA Ex. Bd. Mtg., Shaw, 1:00 P.M.	10	11 VETERANS' DAY SCHOOL CLOSED	12
13	14 AMERICAN EDUCATION WEEK BEGINS	15	16 Report Cards Issued	17 Parent-Faculty Sports Night & Gen. Mtg., Clear Stream, 7:30 P.M.	18	19 PTA Dance, Clear Stream, at K of C Hall, 9:00 P.M.; PTA Art Auction, Shaw, 7:30 P.M.
20	21	22 Dist. No. 30 Bd. of Ed. Mtg., 8:15 P.M.	23 SCHOOL CLOSSES AFTER THE MORNING SESSION	24 THANKSGIVING DAY SCHOOL CLOSED	25 SCHOOL CLOSED	26
27	28	29	30	How can a person feel Liked, unless somebody likes him, Wanted, unless somebody wants him, Acceptable, unless somebody accepts him, Able, unless somewhere he has some success,		

CLEAR STREAM AVENUE PARENT TEACHER ASSOCIATION

ELECTED OFFICERS 1977-1978

Co-Presidents	Eileen Calandrino	825-6470
	Lenore Vita	285-5394
First Vice President	Sandy Henry	825-6572
Second Vice President	Barbara Parisi	825-3214
Treasurer	Tommy Fonte	872-0148
Membership	Ann Prisco	285-5744
Recording Secretary	Fran Gentile	872-3206
Corresponding Secretary	Roseann Petruzillo	285-4795
Delegates to Council	Mary Maclean	Faculty
	Marge Rollo	825-0929
	Jean Sevello	
Past Presidents	Sue Farrell	872-8026
	Kay McDonald	825-3313

COMMITTEE CHAIRMEN

Arts & Flyers	Fran Passarelli	872-9429
Audio-Visual	Frank DeMarco	Faculty
Budget	Sue Farrell	872-8026
Community Relations	Rhoda Schacter	Faculty
Cultural Arts	Linda Pratt	Faculty
Distribution	Kay Ciccone	LO 1-9207
Health	Emily Giganti	285-8432
Historian	Kay McDonald	825-3313
Hospitality	Becky Sheil	285-7779
	Stella Rusylnak	285-8094
	Florence Volpe	872-3517
	Arlein Ercole	285-8127
Human Relations	Barbara McLaughlin	825-6162
Juvenile Protection	Lois Barry	285-8654
Legislation	Barbara Parisi	825-3214
Pre-School	Cheryl Holton	561-9055
Publicity	Diana Doino	825-3571
School & Community	Sandy Henry	825-6572
Streamer	Ann Prisco	285-5744
Sunshine	Rosemary Smith	561-8667
Ways & Means	Roseann Petruzillo	285-4795
Bowling President	Evelyn McGowan	285-4712
Secretary	Dottie Waiz	872-8011
Treasurer	Terry Keller	285-7016
Grade Rep. Chairman	Maureen Kelly	872-6725
Kindergarten Grade Rep.	Marion Acquavella	825-2272
1st Grade Rep.	Faith Breiner	285-9087
2nd Grade Rep.	Gerry Sullivan	561-8694
3rd Grade Rep.	Ann Prisco	285-5744
4th Grade Rep.	Cheryl Holton	561-9055
5th Grade Rep.	Barbara Parisi	825-3214

P.T.A. PROGRAM

Sept.	8	Executive Board Meeting, 9:30 a.m.
	28	General Meeting and Parents' Night, 7:30 (K-3)
	29	General Meeting and Parents' Night, 7:30 (4-6)
Oct.	6	Executive Board Meeting, 9:30 a.m.
	13	Jelly Apple Sale, 2:45 p.m.
	14	Jelly Apple Sale, 2:45 p.m.
	28	5th and 6th Grade Halloween Party, 7:30 p.m.
Nov.	3	Executive Board Meeting, 9:30 a.m.
	17	Family-Faculty Sports Night & Gen. Mtg., 7:30 p.m.
	19	Fall Dance at St. Theresa Knights of Columbus, 9:00 p.m.
Dec.	1	Executive Board Meeting, 9:30 a.m.
	13	Pre-School Meeting, 1:30 p.m. (Parents of 4 yr. olds)
	15	Holiday Boutique, 2:45 p.m.
	16	Holiday Boutique, 2:45 p.m.
	23	Holiday Assembly, 1:30 p.m.
Jan.	5	Executive Board Meeting, 9:30 a.m.
	9	Sex Hygiene Film for 5th and 6th Grade Parents, 7:30 p.m.
	10	Sex Hygiene Film for 6th Grade Children, 3:00 p.m.
	12	Sex Hygiene Rap Session for 6th Grade Children, 3:00 p.m.
	19	General Meeting, 8:00 p.m.
Feb.	2	Executive Board Meeting, 9:30 a.m.
	9	Founders' Day Meeting, 8:30 p.m.
	17	Cake Sale, 2:45 p.m.
Mar.	2	Executive Board Meeting, 9:30 a.m.
	3	Father, Son and Daughter Night, 7:30 p.m.
	14	Pre-School Meeting, 1:30 p.m. (Parents of 4 yr. olds)
	16	General Meeting, 8:00 p.m.
	21	Pre-School Meeting, 1:30 p.m. (Parents of 3 yr. olds)
Apr.	6	Executive Board Meeting, 9:30 a.m.
	7	Cultural Arts Assembly, 1:30 p.m.
	15	Vision Screening, 9:00 a.m.
	20	Teachers' Recognition Day, 11:00 a.m.
May	1	Art Exhibit and Cake Sale, 7:30 p.m.
	4	Executive Board Meeting, 9:30 a.m.
	7	Hygiene Film for 4th Grade Girls, 3:00 p.m.
	11	Mothers' Day Boutique, 2:45 p.m.
	12	Mothers' Day Boutique, 2:45 p.m.
	18	General Meeting and Installation, 8:15 p.m.
June	2	Joint Executive Board Meeting, 9:30 a.m.

DECEMBER 1977

DAY	MONDAY	TUESDAY	WEDNESDAY	THURSDAY	FRIDAY	SATURDAY
				1	2	3
				PTA Ex. Bd. Mtg., Clear Stream, 9:30 A.M.; PTA Holiday Boutique, Forest, 2:45 P.M.		
4	5	6	7	8	9	10
	CHANUKAH		PTA Gen. Mtg., Shaw, 8:15 P.M. "Metrics by Mr. Cid"; PTA Ex. Bd. Mtg., Forest, 8:00 P.M.		PTA Holiday Assembly, Shaw	
11	12	13	14	15	16	17
	Pre-school Mtg., Shaw & Washington, 3:00 P.M.; PTA Council Mtg., Shaw	C.H.S. Bd. of Ed. Mtg., 8:00 P.M.; Pre-school Mtg., Clear Stream, 1:30 P.M.	PTA Holiday Boutique, Shaw & Washington	PTA Holiday Boutique, Clear Stream, 2:45 P.M.	PTA Holiday Boutique, Clear Stream, 2:45 P.M.	
18	19	20	21	22	23	24
		Dist. No. 30 Bd. of Ed. Mtg., 8:15 P.M.			PTA Holiday Assembly, Clear Stream, 1:30 P.M.	
25	26	27	28	29	30	31

SHAW AND WASHINGTON AVENUES PARENT TEACHER ASSOCIATION

ELECTED OFFICERS 1977-1978

President	Marianne Bono	285-6405
Vice President	Grace Duffe	561-9291
Secretary	Elaine Mosca	825-0414
Assistant Secretary	Lois Patranzino	285-5102
Public Relations Secretary	Vera Manzo	872-8717
Membership Secretary	Margaret Nugent	872-6378
Activities Secretary	Angela Rodi	285-4951
Advisory Council	Miriam Sweet	Faculty
	Carol Blankshine	825-3119
	Cathy Barbara	285-8469
	Elaine Kelly	825-0113

COMMITTEE CHAIRMEN

Visual Arts & Programs	Mr. J. Giacalone	Faculty
Art Auction	Lillian Ging	285-6072
Art & Programs	Judy Delgado	872-0817
Art Auction	Vera Manzo	872-8717
Art & Programs	Claire Piemonte	825-8032
Art Auction	Marie Hutnick	872-8537
Art & Programs	Claire Piemonte	825-8032
Art Auction	Kathy Pellegrino	285-5764
Art & Programs	Jeanette Alloro	285-7269
Art Auction	Angela Rodi	285-4951
Art & Programs	Cathy Barbara	285-8469
Art Auction	Ann Bochichio	285-7865
Art & Programs	Angela Maglione	825-7440
Art Auction	Edwina Mateo	285-9795
Art & Programs	Camille Audino	285-6212
Art Auction	Pat Soltero	285-6373
Art & Programs	Carol Blankshine	825-3119
Art Auction	Joanne Owens	872-0481
Art & Programs	Marcie Brown	285-5161
Art Auction	Nancy Daly	285-6058
Art & Programs	Lucille Mazza	285-7926
Art Auction	Marie Verriello	285-5171
Art & Programs	Edwina Mateo	285-9795
Art Auction	Margaret Nugent	872-6378
Art & Programs	Nancy Daly	285-6058
Art Auction	Grace Duffe	561-9291
Art & Programs	Elaine Mosca	825-0414

(Inclusion, Boutiques, Cupcake Sale, Sweat Shirt Sale, Fashion Show)

P.T.A. PROGRAM

Sept.	12	4th, 5th and 6th Grade Jr. Bowling Meeting, Shaw, 3:30 P.M.
	15	Parents Night, Shaw (Grades K-3), 8:15 P.M.
	15	PTA Bowling Starts
	19	Jr. Bowling Starts
	21	PTA Executive Board Meeting, Shaw, 1:00 P.M.
	27	Parents Night, Washington, 8:15 P.M.
	29	Parents Night, Shaw (Grades 4-6) 8:15 P.M.
Oct.	7	Sweat Shirt Sale, Shaw & Washington
	8	PTA Flea Market, Shaw
	12	PTA Executive Board Meeting, Shaw, 1:00 P.M.
	14	Cultural Arts Assembly, Shaw
	21	PTA Social Night, Shaw, 8:00 P.M.
Nov.	9	PTA Executive Board Meeting, Shaw, 1:00 P.M.
	19	Art Auction, Shaw, 7:30 P.M.
Dec.	7	PTA General Meeting, Shaw (Metrics by Mr. Cid), 8:15 P.M.
	9	Holiday Assembly, Shaw
	12	Pre-School Meeting, Shaw and Washington, 3:00 P.M.
	14	Holiday Boutique, Shaw and Washington
Jan.	11	Cupcake Sale, Shaw and Washington
	18	PTA General Meeting, Shaw, 8:15 P.M.
Feb.	10	PTA Family Night at the Movies, Shaw, 7:30 P.M.
	15	PTA Executive Board Meeting, Shaw, 1:00 P.M.
Mar.	9	Fashion Show, Diplomat, 8:00 P.M.
	13	Pre-School Meeting, Shaw & Washington, 3:00 P.M.
	15	PTA Executive Board Meeting, Shaw, 1:00 P.M.
Apr.	15	Vision Screening, Shaw, A.M.
	19	PTA General Meeting, Shaw, 8:15 P.M.
May	10	Mothers Day Boutique, Shaw and Washington
	17	Pre-School Meeting, Shaw and Washington, 3:00 P.M.
	17	PTA Executive Board Meeting, Shaw, 1:00 P.M.
	18	PTA General Meeting, Installation, 8:00 P.M.
	24	Teachers Recognition Day Luncheon, Shaw
June	7	PTA Joint Executive Board Meeting, Shaw, 1:00 P.M.
	12	PTA Volunteers Meeting, Shaw, 10:00 A.M.
	14	Fathers Day Boutique, Shaw and Washington

JANUARY 1978

SUNDAY	MONDAY	TUESDAY	WEDNESDAY	THURSDAY	FRIDAY	SATURDAY
1	2	3	4	5	6	7
PAR'S DAY	CHRISTMAS RECESS SCHOOL CLOSED	SCHOOL OPENS	PTA Ex. Bd. Mtg., Forest, 8:00 P.M.	PTA Ex. Bd. Mtg., Clear Stream, 9:30 A.M.		
8	9	10	11	12	13	14
	Family Living Program, 5th & 6th Gr. Parents, Clear Stream, 7:30 P.M.	C.H.S. Bd. of Ed. Mtg., 8:00 P.M.; Family Living Program, 6th Gr. pupils & parents, Clear Stream, 3:00 P.M.	Cupcake Sale, Shaw & Washington	Family Living Rap Session, 6th Gr. Pupils, Clear Stream, 3:00 P.M.		
15	16	17	18	19	20	21
		PTA Gen. Mtg., Forest, 8:15 P.M.	PTA Gen. Mtg., Shaw, 8:15 P.M.	PTA Gen. Mtg., Clear Stream, 8:00 P.M.		
22	23	24	25	26	27	28
		Dist. No. 30 Bd. of Ed. Mtg., 8:15 P.M.				
29	30	31	I have no right, by anything I say or do, to demean a human being in his own eyes. What matters is not what I think of him; it is what he thinks of himself. To undermine a man's self-esteem is a sin. —Antoine De Saint-Exupery			

ELECTED OFFICERS 1977-1978

resident	Rochelle Koval	791-1232
First Vice President	Ruth Bazil	791-8556
Second Vice President	Judy Orloff	791-3820
Treasurer	Marie Spiwak	791-3307
Financial Secretary	Abby Tedesco	791-2157
Corresponding Secretary	Rhoda Levine	791-3148
Recording Secretary	Roz Scheidt	791-9468
Delegates to Council	Trena Danels	791-1506
	Lydia Rosen	791-5488
	Joan Frichling	791-7663

COMMITTEE CHAIRPERSONS

Assembly	Sandy Alexander	825-3457
Bowling (children)	Betty Sabbatini	791-8165
Budget	Harriet Drucker	791-6452
Class Mothers	Ruth Bazil	791-8556
Cultural Arts	Audry Chason	791-8248
Children's Theater	Lenora Paletz	791-5274
Ecology	Adrienne Eisner	791-3622
Family Living	Barbara Spetalnick	791-3389
Fliers	Sandra Train	791-8221
Foodwill	Carol Mutterpearl	791-1060
Hospitality	Sima Pomerantz	791-4019
Health & Safety	Harriet Schulman	791-7437
Historian	Carol Provanzano	825-5915
Legislation	Linda Jones	791-5816
Membership	Dorothy Alpersen	791-2284
Timeograph	Arlene Panzer	791-3652
Newsletter	Gloria Feig	791-6315
Parliamentarian	Edna Crescas	791-5972
Pre-School	Pat Block	791-4920
Program Chairperson	Judy Blancher	791-2499
School Bd. Rep.—Elem.	Abby Tedesco	791-2157
Teacher's Rep.	Carol Provanzano	825-5915
Typist	Karen Fox	825-0105
Days & Means	Paulette Kirschenbaum	791-7045
Boutique	Rhoda Levine	791-3148
Book Fair	Judy Orloff	791-3820
Cake Sale	Marcia Langbart	791-8442
	Blossom Melnick	Faculty
	Donna Lobell	791-4568
	Judy Orloff	791-3820
	Judy Azzolina	791-4785
	Sue Baxter	791-6084
	Marilyn Sparber	791-6836
	Elaine Sander	791-5765

**Plant Sale
Carnival**

Marie Spiwak	791-3307
Phyliss Wolin	791-8120
Barbara Tankel	791-4276
Claudia Markowski	791-1017
Barbara Smerling	791-2540

Board Listings

P.T.A. PROGRAM

Sept.	20	Meet the Teacher Night
Oct.	5	Executive Board Meeting, 8:00 P.M.
	7	5th & 6th Grade Bowling begins
	18	General Meeting, 8:15 P.M.
	28	6th Grade Halloween Party
Nov.	2	Executive Board Meeting, 8:00 P.M.
	8	Cake Sale
Dec.	1	Holiday Boutique, 2:45 P.M.
	7	Executive Board Meeting, 8:00 P.M.
Jan.	4	Executive Board Meeting, 8:00 P.M.
	17	General Meeting, 8:15 P.M.
Feb.	1	Executive Board Meeting, 8:00 P.M.
Mar.	1	Executive Board Meeting, 8:00 P.M.
	14	General Meeting, 8:15 P.M.
	18	PTA Carnival
Apr.	5	Executive Board Meeting, 8:00 P.M.
	14	PTA Book Fair
May	3	Executive Board Meeting, 8:00 P.M.
	10	PTA Plant Sale, 2:45 P.M.
	11	Teacher's Recognition Luncheon, 11:30 A.M.
	16	General Meeting, 8:15 P.M.
	31	Executive Board Meeting, 8:00 P.M.

FEBRUARY 1978

SUNDAY	MONDAY	TUESDAY	WEDNESDAY	THURSDAY	FRIDAY	SATURDAY
			1 Report Cards Issued; PTA Ex. Bd. Mtg., Forest, 8:00 P.M.	2 PTA Ex. Bd. Mtg., Clear Stream, 9:30 A.M.	3	4
5	6 PTA Council Mtg., Donahue School	7	8 ASH WEDNESDAY	9 PTA Founders' Day Program, Clear Stream, All schools, 8:30 P.M.	10 PTA Family Night at the Movies, Shaw, 7:30 P.M.	11
12	13	14 C.H.S. Bd. of Ed. Mtg., 8:00 P.M.	15 PTA Ex. Bd. Mtg., Shaw, 1:00 P.M.	16	17 PTA Cake Sale, Clear Stream, 2:45 P.M.	18
19	20 WINTER RECESS SCHOOL CLOSED	21 WINTER RECESS SCHOOL CLOSED	22 WASHINGTON'S BIRTHDAY SCHOOL CLOSED	23 WINTER RECESS SCHOOL CLOSED	24 WINTER RECESS SCHOOL CLOSED	25
26 SCHOOL REOPENS	27	28 Dist. No. 30 Bd. of Ed. Mtg., 8:15 P.M.	Work is love made visible, and if you cannot work with love but only with distaste it is better that you should leave your work and sit at the gate of the temple and take alms of those who work with joy. For if you bake bread with indifference you bake bread that feeds but half of a man's hunger. —Kahlil Gibran, In the Prophet			

THE DEVELOPMENT OF PERCEPTUAL SKILLS

The close relationship between perceptual development of the young child and the learning process has been well established.

Perception is the ability to understand the world around us. It involves the brain's interpretation of what the eyes see into patterns of meaning and action. No one is born with this ability; it is developed. It does not have a direct connection with intelligence. A child develops perceptual skills through the use of all his senses. The greatest period of perceptual growth occurs between the ages of 3-1/2 and 8 years.

Perceptual ability is more than receiving sensory impressions from the world around us through one's body. It is the ability to identify and interpret these sensory impressions and also to integrate them with previous experiences.

The following is a brief outline of the kinds of activities you and your child can do together which will help to develop perceptual skills and abilities within this five year span. It should be remembered however that children develop at different rates and the activities selected should be within the child's capabilities.

I. MOTOR DEVELOPMENT

- A. Large muscle coordination:
 1. Games involving skipping, jumping, climbing, hopping and throwing.
 2. Creeping and crawling games (such as following knee and hand prints along a course).
- B. Fine motor coordination:
 1. Buttoning
 2. Lacing
 3. Clay work
 4. Finger painting
 5. Puzzles
- C. Visual-Motor Activities
 1. Ball throwing and catching
 2. Nail pounding
 3. Bead stringing
 4. Block building

II. BODY IMAGE

The child has to develop an understanding of the left and right side of his own body, as well as an understanding of what is the left or right side of whatever object he is looking at. The child must know that left or right are always in reference to himself.

- A. Identification of body parts (touch your toes, head, neck, etc.).
- B. Figure assembly.

III. PERCEPTUAL CONSTANCY

This refers to the ability to recognize an object regardless of its position, color, size and brightness.

- A. Matching and sorting different geometric shapes or objects.
- B. Picture selection on the basis of likenesses or differences
- C. Finding different sizes of the same objects.

IV. AUDITORY PERCEPTION

This refers to the ability to discriminate between different sounds and associate these sounds with previous experiences.

- A. Listening to records
- B. Listening games in which the child must:
 1. Identify various sounds (humming, clapping, tapping, etc.)
 2. Discriminate between high and low pitch, loud and soft, like and unlike, and near and far sounds

V. TACTILE DISCRIMINATION

- A. Seeing, touching and comparing objects of different texture, temperature, and size.
- B. Identifying different shapes when blindfolded.

This limited list of suggested activities will aid your child in developing the ability to select and coordinate the information he receives through his senses and provide a base for future learning.

ADA KEANEY
Reading Consultant

MARCH 1978

SUNDAY	MONDAY	TUESDAY	WEDNESDAY	THURSDAY	FRIDAY	SATURDAY
<p>day, maybe there will exist a well-informed, well-versed, and yet fervent public conviction that the leadly of all possible sins is the mutilation of a spirit.</p> <p style="text-align: right;">—Erik Erikson</p>			1 PTA Ex. Bd. Mtg., Forest, 8:00 P.M.	2 PTA Ex. Bd. Mtg., Clear Stream, 9:30 A.M.; "Lights On" PTA Program, Memorial Jr. High, 8:00 P.M.	3 PTA Father-Son- Daughter Night, Clear Stream, 7:30 P.M.	4
5	6	7	8	9 PTA Fashion Show at the Diplomat, Shaw, 8:00 P.M.	10	11
12	13 Pre-school Mtg., Shaw & Washington, 3:00 P.M.	14 C.H.S. Bd. of Ed. Mtg., 8:00 P.M.; Pre-school Mtg., Clear Stream, 1:30 P.M.; PTA Gen. Mtg., Forest, 8:15 P.M.	15 PTA Ex. Bd. Mtg., Shaw, 1:00 P.M.	16 PTA Gen. Mtg., Clear Stream, 8:00 P.M.	17 ST. PATRICK'S DAY; Dist. Music Concert. Shaw, 8:15 P.M.	18 PTA Carnival, Forest
19	20	21 Dist. No. 30 Bd. of Ed. Mtg., 8:15 P.M.; Pre-school Mtg., Clear Stream, 1:30 P.M.	22	23 PURIM; HOLY THURSDAY	24 GOOD FRIDAY; SCHOOL CLOSED	25
26	27 EASTER RECESS	28 EASTER RECESS	29 EASTER RECESS	30 EASTER RECESS	31 EASTER RECESS	

THE TEACHING OF RESPONSIBILITY

If we are trying to effect "a school without failure,"* then of the most important tasks is the teaching of responsibility. Children learn by means of a loving relationship with responsible parents, an involvement which implies parental example and parental teaching. Through the proper combination of love and discipline the responsible parent creates the necessary involvement with his child and teaches him responsibility. Children, who are not exposed early in their lives to others who care about them enough to love and discipline them, may never learn to be responsible. For that failure they may suffer irremediably.

Responsibility can be learned at any age. Never-the-less, it is easier to learn correctly at first than to overcome bad habits. Learning how to study in college is more difficult than learning in elementary or high school.

Many parents will agree—that children do not learn responsibility easily. Children do not know that what seems so simple to them will not fulfill their needs, so almost from infancy they rebel against reality that they must learn from their parents how to fulfill their needs. Later, when they are old enough to recognize reality, they test their parents with irresponsible behavior. Through discipline, tempered with love, parents are teaching their children to behave better. The child always knows that the parent cares.

Children want to become responsible, but they won't accept discipline and learn better ways unless they feel the parents care enough to show them actually the responsible way to live.

A common example is the child who wants to play with friends or watch television even though he has not done his homework. He promises, threatens, begs and cajoles his parents in an effort to evade his responsibility. He sometimes succeeds in his way, but has he learned about reality? Confronted in school with his homework not completed, he will often blame his parents and not himself, thus further compounding his own responsibility. Later when he is faced with a difficult situa-

tion, not having learned responsibility, he is unprepared to cope with it. Parents, who are willing to suffer the pain of the child's intense anger by firmly holding him to the responsible course, are teaching him a lesson that will help him his entire life. Parents who do not do so are setting the pattern for further irresponsibility, which prevents the child from fulfilling the need to feel worthwhile—to be a failure.

Parents must not only hold the child to the correct course of action, but also they must show by example that they are also capable of taking the responsible course. Parents cannot successfully discipline a child unless they are self-disciplined. A parent who never reads a book, or who spends a great amount of time in front of the television screen and doesn't demonstrate any of the values of using his intellect, will be hard-pressed to teach his child the value of doing well in school through diligent study. The child who does not learn by instruction and example will not respect his parents. If they continue to fail him, he may cease to love them because, in a sense, they are depriving him of a chance to fulfill his needs. When discipline is reasonable and understandable, and when the parents' own behavior is consistent with their demands on the child, he will love and respect them even though his surface attitude may not always show it. Parents must understand that taking the responsible course will never permanently alienate the child.

Children learn responsibility through involvements with fellow human beings, preferably loving parents and teachers, who will love and discipline them properly; who are intelligent enough to allow them the freedom to try out their newly acquired responsibility as soon as they show readiness to do so.

HELEN FINK
Special Counselor
Forest Road School

*Glasser, William, M.D., *Schools Without Failure*, Harper & Row, New York, 1969.

APRIL 1978

SUNDAY	MONDAY	TUESDAY	WEDNESDAY	THURSDAY	FRIDAY	SATURDAY
						1
Intelligence builds a dinosaur's skeleton from a few bones; but we must beware, for intelligence also built Piltdown Man, a forgery, from spurious fragments. In other words, intelligence is not in itself right and good. It is capable of magnificent lies, prodigies of evil-doing. Yet it is also the instrument that man must mainly use to save himself. —John Hersey, in "Intelligence, Choice and Consent."						
2	3 PTA Council Mtg., Daver School; SCHOOL REOPENS	4	5 PTA Ex. Bd. Mtg., Forest, 8:15 P.M.	6 PTA Ex. Bd. Mtg., Clear Stream, 9:30 A.M.	7 PTA Cultural Arts Assembly, Clear Stream, 1:30 P.M.; Shaw Chorus Program, 8:15 P.M.	8
9	10	11 C.H.S. Bd. of Ed. Mtg., 8:00 P.M.	12	13	14 PTA Book Fair, Forest	15 PTA Vision Screening, Clear Stream & Shaw
16	17	18	19 PTA Gen. Mtg., Shaw, 8:15 P.M.	20 Teacher's Recognition Day, Clear Stream	21	22 First Day of Passover
23 Easter Day	24	25 Dist. No. 30 Bd. of Ed. Mtg.,	26	27 Reg. for Budget vote, Each school, 7-9 A.M.; 4-9 P.M.; Art Exhibit,	28 Seventh Day of Passover; Reg. for next year's Kindergarten, Each school,	29 Eighth Day
30						

SCHOOL POLICIES

SCHOOL HOURS

hours for grades 1, 2, and 3 are from 9:00 a.m. to 3:00 p.m.
hours for grades 4, 5, and 6 are from 8:30 a.m. to 2:45 p.m.

LUNCH

is served beginning with the first day of school. Pupils go home for lunch, bring lunch from home, or buy the lunch in the cafeteria for 50c. Monthly menus are provided so that if foods are served which your child does not eat, you can make other provisions for him for those days. In case your child forgets his lunch money or his lunch, or loses either, we have a charge system to cover the emergency except the week of a recess and summer vacation. The cashier in the cafeteria keeps the record of such charges and contacts the parents should a charge not be paid in a reasonable time.

ICE CREAM

Ice cream is sold daily to those pupils who wish it. It is *not* included in the hot lunch and costs an additional 15c.

RECESS MILK

Recess milk is available to all children beginning about the first week of the school year and is sold at a cost of 50c per quart, payable each Thursday for the following week. You will be notified as to exact date. Money brought in late (Friday) cannot be accepted. In case of a child's absence, no refund is made for periods of less than a full week.

ABSENCES

If your child has been absent, State law requires that he bring a note from you explaining the absences and the date(s) of absence(s). The note should be presented to the nurse *before* he goes to the classroom. Please be specific. Just saying, "he was absent" is not enough. Indicate whether it was "virus," "fever," "flu," etc. A note is required for an absence due to a religious holiday. A note is required for any tardiness, giving the reason. If your child contracts a contagious disease, such as mumps, measles, etc., please phone the school nurse so that she can advise the parents in your child's class that their children have been exposed. Be sure to keep the emergency card up to date so that we will know whom to call should your child become ill and need to go home.

NOON HOUR RULES

When pupils misbehave in the cafeteria, auditorium, or on the playground during the noon hour, after repeated reminders, the teachers have the authority to exclude them from staying in school for lunch for a few days, or longer, depending on the misbehavior. If you receive such a note from us, we would appreciate your cooperation. Whether or not a mother is home during the noon hour has no bearing on this exclusion.

RELEASED TIME FOR RELIGIOUS INSTRUCTION

A Release Form signed by the parent is necessary should you want your child excused from school for religious instruction. Such forms can be obtained from your church. The time provided is the last hour of school on Wednesday afternoons.

EXITS AND ENTRANCES

Your child's class is assigned a specific exit and entrance to use. You will thus know where to meet him if you come to pick him up. Parents picking up children are asked to meet them at the exit, *not* the classroom.

ENTRANCE TIMES

Morning — All Schools	Noontime — Shaw & Forest
Grades 1, 2, & 3 — 8:50	Grades 1, 2, & 3 — 12:50
Grades 4, 5, & 6 — 8:20	Grades 4, 5, & 6 — 12:20
Noontime — Clear Stream: Grades 5 & 6 — 12:05	
Grades 3 & 4 — 12:35; Grades 1 & 2 — 1:05	

Because there is no supervision of the playground in the morning, we suggest you arrange your child's departure from home to allow him to arrive just in time to enter the building during the proper interval. In inclement weather he may come into the designated area five minutes before the above times.

CLASS INTERRUPTIONS

No unnecessary interruptions of classes are allowed once the day's sessions have begun. When your child forgets a book, homework, sneakers, lunch money, etc., please bring these to the office. All pupils are instructed to check with the office at lunch time for such forgotten items. In the interest of the child's all-round education, we urge you not to make a practice of bringing forgotten items to school. The child should be developing his own sense of responsibility for these things.

MAY 1978

SUNDAY	MONDAY	TUESDAY	WEDNESDAY	THURSDAY	FRIDAY	SATURDAY
	1	2	3 Voting on School Budget, Each school, 7:00 A.M. to 10:00 P.M.; PTA Ex. Bd. Mtg., Forest, 8:00 P.M.	4 PTA Ex. Bd. Mtg., Clear Stream, 9:30 A.M.	5	6
7	8 Art Exhibit, Clear Stream, 7:30-9:00 P.M.	9 Art Exhibit, Forest, 7:30-9:00 P.M.	10 Mother's Day Boutique, Shaw & Washington; PTA Plant Sale, Forest, 2:45 P.M.	11 Teacher's Recognition Day Luncheon, Forest, 11:30 A.M. Mother's Day Boutique, Clear Stream, 2:45 P.M.;	12 Mother's Day Boutique, Clear Stream, 2:45 P.M.	13
14	15 Pre-school Mtg., Shaw & Washington, 3:00 P.M.	16 PTA Gen. Mtg., Forest, 8:15 P.M.	17 PTA Ex. Bd. Mtg., Shaw, 1:00 P.M.	18 PTA Inst. Mtg., Clear Stream, 8:15 P.M. & Shaw, 8:00 P.M.	19	20
21	22	23 Dist. No. 30 Bd. of Ed. Mtg., 8:15 P.M.	24 Teacher's Recognition Day, Shaw	25	26	27
28	29	30 MEMORIAL DAY	31 PTA Ex. Bd. Mtg.,	If a school teacher in St Joseph, Missouri, hadn't put a comforting arm around me one day and made me welcome in my little world, I might well have done something foolish and desperate. —Irving Ben Cooper, New York Judge		

SCHOOL POLICIES

GYM SUITS AND SNEAKERS

Gym suits are required of pupils below the 3rd grade, but are necessary for any pupils using the gym. Boys and girls from the 3rd through 6th grades are required to wear gym suits and sneakers on the assigned gym days. The gym teachers explain this to the pupils, but many times they do not bring correct information home.

Who **MUST PURCHASE A NEW SUIT** should buy the piece **ROYAL BLUE**, bloomer type, with elastic bottoms, or **ROYAL BLUE** shorts with elastic insert in the cuff, and a white shirt. Boys should wear **ROYAL BLUE** shorts, with elastic top, and sneakers (high top ones preferred), and white or **SCHOOL "T"** shoes.

IF A CHILD HAS ANOTHER COLOR, OR TYPE, HE DOES NOT NEED TO BUY A NEW ONE. The above apparel may be purchased at many local stores in Valley Stream. **NO ONE IS ALLOWED ON THE GYM FLOOR WITHOUT SNEAKERS.**

APPOINTMENTS WITH TEACHERS

Remember that pupils' classtime be used to the fullest advantage, and request that parents do not seek conferences with teachers during school hours. If you wish a conference, please make an appointment to see the teacher after school. Teachers are available for such conferences every day except Wednesdays and Fridays.

BICYCLES

Bicycles are allowed at either Forest Road or Clear Stream Elementary Schools because no child lives far enough from the school to make them necessary. They are allowed at Shaw, but are restricted to pupils in grades 4, 5, and 6 who live **NORTH OF FOREST AVENUE**. Bicycles used to come to the Shaw Avenue School will be assigned a number. All must have a lock and helmet for safety purposes.

GIFTS TO TEACHERS PROHIBITED

Policy of the school district which became effective January 1, 1956, is to prohibit the acceptance of gifts by faculty members on school premises, and to prohibit the solicitation of funds for personal gifts purposes, by any person, or persons on the premises.

IN-DAY PROGRAM

In inclement weather, there is an in-day program of motion pictures provided for those pupils who eat in the cafeteria. Pupils who go home to lunch are not allowed to participate in this program because of space limitations, so we ask parents to return these pupils to school on such days just in time for the afternoon session—not before 12:50 p.m. for grades 1 to 3, and 12:20 p.m. for grades 4 to 6 at Shaw and Forest; and not before 12:05 for grades 5 and 6, 12:35 for grades 3 and 4, and 1:05 for grades 1 and 2 at Clear Stream.

HOMEWORK REQUIREMENTS

Homework is required of all pupils, but it will vary from day to day. First and second grade pupils may have fifteen to twenty minutes of homework per day, while third and fourth grade pupils are likely to have thirty to forty minutes. Fifth and sixth graders are expected to devote as much as an hour to homework, but again this may not be every day—it will depend on the pupil and his needs.

LOST AND FOUND

Unmarked articles lost by pupils are placed in the Lost-and-Found, which is in the Nurse's Office at Shaw & Forest, and the custodian's office at Clear Stream. Such articles, if not claimed at the end of the school year, are given to a charitable organization. However, any article bearing a child's name is returned directly to him. Please place your child's name on all his belongings.

STAYING AFTER SCHOOL

To eliminate any confusion or problems, the school may have your child every day for an additional half hour. During this half hour beyond the regular school day, the teacher may schedule your child for special help or keep him for any of several reasons. We ask that you keep this in mind and not schedule dental appointments, dancing lessons, etc. until after that interval. Teachers are also available to parents during the half hour after school, except on Wednesday and Friday, for conferences.

ASSEMBLIES

When your child's class puts on the assembly, we welcome your attendance, but we do ask you not to bring pre-school children. As much as we realize that it is a thrill for them to see big brother perform, they are often distracting to all concerned. Picture taking is not allowed without prior approval.

JUNE 1978

DAY	MONDAY	TUESDAY	WEDNESDAY	THURSDAY	FRIDAY	SATURDAY
			—Isaac Azimov —Unknown	1 PTA Joint Bd. Mtg., Clear Stream, 9:30A.M.	2	3
	4	5 String Festival, Shaw, 7:30 P.M.	6 String Festival, Clear Stream, 7:30 P.M.	7 PTA Joint Bd. Mtg., Shaw, 1:00 P.M.; String Festival, Forest, 7:30 P.M.	8	9 10
11	12 Volunteers' Mtg., Shaw, 10:00 A.M.; PTA Council Mtg., North H.S.	13 C.H.S. Bd. of Ed. Mtg., 8:00 P.M.	14 FLAG DAY; Father's Day Boutique, Shaw & Washington	15	16	17
18	19	20	21 GRADUATION DAY	22	23 LAST DAY OF SCHOOL	24
25	26	27 Dist. No. 30 Bd. of Ed. Mtg., 8:15 P.M.	28	29	30	

SHAW AND WASHINGTON AVENUE SCHOOLS

CLASS MOTHER LIST

Class Mother Chairman

Cathy Barbara, 285-8469

Gr. Room	Class Mother	Tel. Number	Teacher		Gr. Room	Class Mother	Tel. Number	Teacher	
Kindergarten Representative				Edie Chiano, 285-7721	4th Grade Representative				Linda Donnigan, 285-7182
K 301	Mrs. Chiano	285-7721	Mrs. Dankoff	4 108	Mrs. Mateo	285-9795	Mr. Carr		
K 101 AM	Mrs. Maglione	825-7440	Miss Blessinger	4 109	Mrs. Verriello	285-5171	Mrs. Benedetto		
K 101 PM	Mrs. Drucker	872-0760	Miss Blessinger	4 110	Mrs. Bookman	285-4418	Mr. Riccobono		
4 114				4 114	Mrs. NickDow	285-4869			
1st Grade Representative				Joann Iglio, 285-6458	5th Grade Representative				Camille Cecere, 285-5579
1 302	Mrs. Herzner	285-9368	Mrs. Hartman	5 116	Mrs. Balducci	872-0173	Miss Melzer		
1 303	Mrs. Mazza	285-7926	Mrs. Lazar	5 118	Mrs. Vasquez	285-5827	Mrs. Hamcke		
1 103	Mrs. Larow	825-2510	Mrs. Levine	5 121	Mrs. Agarenzo	825-7951	Mrs. Seid		
1 105	Mrs. Mandzik	872-8723	Mrs. Graffigno	5 122	Mrs. Winter	872-3968	Mr. Beyer		
2nd Grade Representative				Ann Bochichio, 285-7865	6th Grade Representative				Judy Delgado, 872-0817
2 128	Mrs. Patranzino	285-5102	Miss Healy	6 123	Mrs. Blankshine	825-3119	Miss Lanell		
2 130	Mrs. Bochichio	285-7865	Miss Cohen	6 124	Mrs. Piemonte	825-8032	Miss Sherman		
2 133	Mrs. Hiner	285-4857	Miss Post	6 125	Mrs. Nugent	872-6378	Mrs. Haydock		
2 135	Mrs. Gambale	285-8897	Mrs. Federici	6 127	Mrs. Panarelli	825-7773	Mr. Giacalone		
3rd Grade Representative				Angela Rodi, 285-4951	Special				
3 104	Mrs. Rodi	285-4951	Mrs. Sweet	CL	Mrs. Hoffman	825-3870	Mrs. Lewis		
3 107	Mrs. Mazzeo	285-5355	Mrs. Strumpf						
3 132	Mrs. Mosca	825-0414	Mrs. Studo						

JULY 1978

SUNDAY	MONDAY	TUESDAY	WEDNESDAY	THURSDAY	FRIDAY	SATURDAY
Young man: So you really think I'll be a poet! Let: It doesn't follow as the night the day. Talent is cheap, you know. One of the attractive features of mediocrity that you can count on it; Mediocrity infallibly begets mediocre. But you can never be sure what the gifted will do. So many of them go straight to hell. Talent without character is the worst kind of curse. —Stanley Kunitz, "American Poetry's Silver Age", Harper's Magazine, October, 1959						1
2	3	4	5	6	7	8
9	10	INDEPENDENCE DAY		12	13	14
16	17	18	19	20	21	22
23	24	25	26	27	28	29
30	31	Dist. No. 30 Bd. of Ed. Mtg., 8:15 P.M.				

CLEAR STREAM AVENUE SCHOOL
CLASS MOTHER LIST

Class Mother Chairman
Theresa Keller, 285-7016

Grade	Room	Class Mother	Tel. Number	Teacher
K AM	9	Regina Doio	825-3571	Gail Starler
K AM	9	Mary Kajaci	285-8457	Gail Starler
K AM	9	MaryAnn McGullam	285-6266	Gail Starler
K AM	9	LouAnn Zollo	825-3581	Gail Starler
K PM	9	Faith Breiner	285-9087	Gail Starler
K PM	9	Carol Gergel	285-8519	Gail Starler
K PM	9	Cheryle Kutch	872-0047	Gail Starler
K PM	9	Carol Moen	285-4881	Gail Starler
K PM	8	Maureen Kelly	872-6725	Christine Murray
K PM	8	Rosemary Smith	561-8667	Christine Murray
K PM	8	Gerry Sullivan	561-8694	Christine Murray
K PM	8	Judy Trink	825-3123	Christine Murray
1	B	Velia Carrillo	285-4687	Dorothy Schaaf
1	B	Lee Egan	825-8975	Dorothy Schaaf
1	B	Marlyn Wong	872-6552	Dorothy Schaaf
1	B	Sandy Henry	825-6572	Dorothy Schaaf
1	OL	Gail Barbata	285-9332	Mary Maclean
1	OL	Carol Lombardo	285-6473	Mary Maclean
1	OL	Jean Sivillo	825-6003	Mary Maclean
1	OL	Ann Stoffa	285-4696	Mary Maclean
1	7	Marion Acquavella	825-2272	Paula Kalhofer
1	7	Carol Biscardi	825-6413	Paula Kalhofer
1	7	Marge Rollo	825-0829	Paula Kalhofer
1	7	Marie Trimboli	285-9023	Paula Kalhofer
2	3	Arleen Ercole	285-8127	Mary Ruschin
2	3	Cathy Nelson	285-7648	Mary Ruschin
2	3	Maureen Richford	825-6518	Mary Ruschin
2	3	Florence Volpe	872-3517	Mary Ruschin
2	5	Faith Breiner	285-9087	Virginia Galati
2	5	Carol Leggio	285-6222	Virginia Galati
2	5	Eileen Calandrino	825-6470	Virginia Galati
2	5	Barbara McLaughlin	825-6162	Virginia Galati
2	6	Ann Aglio	872-3926	Lillian Guberman
2	6	Theresa Benedetto	285-5410	Lillian Guberman
2	6	Amelia Pascoello	872-3119	Lillian Guberman
2	6	Marlyn Schneider	825-5380	Lillian Guberman
3	1	Donna Diana	825-5174	Karen Firpo
3	1	Fran Passarelli	872-9420	Karen Firpo
3	1	Gerry Sullivan	561-8694	Karen Firpo
3	1	Mary Werkmeister	872-8987	Karen Firpo
3	2	Cathy Cardalena	825-5431	Dale Schindelmann
3	2	Jean Geist	872-6446	Dale Schindelmann
3	2	Barbara LaCroce	825-8579	Dale Schindelmann
3	2	Leonore Vita	285-5394	Dale Schindelmann
3	4	Ruth Fiumaro	825-5055	Louise Quinn
3	4	Connie Magrino	285-7037	Louise Quinn
3	4	JoAnn Santoro	285-8905	Louise Quinn
3	4	Mary Tragner	285-9502	Louise Quinn
4	23	Fran Cingiglio	285-7996	Barbara Nancken
4	23	Beverly Jablonowski	825-0994	Barbara Nancken
4	23	Ruth Settapani	285-5725	Barbara Nancken
4	23	Rosemary Smith	561-8667	Barbara Nancken
4	24	Joan Bauer	872-9078	Helen Inwald
4	24	Winnie Eulner	285-7572	Helen Inwald
4	24	Roseann Petruzillo	285-4795	Helen Inwald
4	24	Ann Frisco	285-5744	Helen Inwald
5	25	Bernice Castello	561-0241	Gerald Camilleri
5	25	Cheryle Holton	561-9055	Gerald Camilleri
5	25	Terry Keller	285-7016	Gerald Camilleri
5	25	Kay Pesce	285-7612	Camilleri

5	27	Gertrude Baerwald	872-3253	Ellen Totten
5	27	JoAnn Esposito	285-6815	Ellen Totten
5	27	Marie Presti	285-9034	Ellen Totten
5	27	Maureen Tkacsik	285-5582	Ellen Totten
5	28	Key Ciccone	561-9207	Marie Gerdyk
5	28	Julie Fiorentino	285-9628	Marie Gerdyk
5	28	Emily Giganti	285-8432	Marie Gerdyk
5	28	Amelia Pascoello	872-3119	Marie Gerdyk
6	21	Fran Carnival	872-0437	David Cooper
6	21	Ann Finazzo	285-6660	David Cooper
6	21	Emily Giganti	285-8432	David Cooper
6	21	Josie Guaneri	285-6239	David Cooper
6	22	Sue Farrell	872-8026	Edith Perinchief
6	22	Pat Lynch	825-5958	Edith Perinchief
6	22	Roseann Potter	872-9337	Edith Perinchief
6	22	Stella Rusinyak	285-8094	Edith Perinchief

FOREST ROAD SCHOOL
CLASS MOTHER LIST

Grade	Room	Class Mother	Tel. Number	Teacher
*K	201	Helene Klein	791-1697	Mrs. Murray
K	201	Alice Fischer	791-3824	Mrs. Murray
K	201	Louise Wenzel	791-6354	Mrs. Murray
1	203	Linda Blank	791-4478	Miss Cafiso
1	203	Edna Crescas	791-5972	Miss Cafiso
*1	203	Judith Orloff	791-3820	Miss Cafiso
1	203	Florence Thebner	791-1608	Miss Cafiso
*2	205	Laura Hans	791-1764	Miss Perrieh
2	205	Sheila Boritz	791-8686	Miss Perrieh
2	205	Phyllis Seltzer	791-2375	Miss Perrieh
2	205	Chickie Heym	561-7237	Miss Perrieh
2	207	Rhoda Levine	791-3148	Mrs. Cummings
*3	207	Abby Tedesco	791-2157	Mrs. Cummings
3	207	Eileen Rosenthal	791-5078	Mrs. Cummings
3	209	Lydia Rosen	791-5488	Miss Clarke
3	209	Carol Mutterperl	791-1060	Miss Clarke
3	209	Betty Fine	791-1806	Miss Clarke
4	210	Evelyn Grabois	791-1604	Mrs. Cabral
4	210	Helen Dickler	791-2771	Mrs. Cabral
4	210	Linda Harris	791-7827	Mrs. Cabral
4	211	Claire Gendelman	791-5811	Mr. Lesser
4	211	Roz Scheidt	791-9468	Mr. Lesser
*4	211	Linda Zahn	791-4516	Mr. Lesser
4	211	Sandy Schaeffer	872-0638	Mr. Lesser
5	215	Betty Sabbatini	791-8165	Miss Schwartz
5	215	Diane Mecker	791-4592	Miss Schwartz
5	215	Pat Block	791-4920	Miss Schwartz
5	215	Barbara Tankel	791-4276	Miss Schwartz
5	218	Sandy Steur	825-2343	Mrs. Kessler
*5	218	Audrey Chason	791-8248	Mrs. Kessler
5	218	Lenora Paletz	791-3274	Mrs. Kessler
6	220	Phyllis Finkle	791-2568	Mr. Kaufmann
6	220	Estelle Glazer	791-5308	Mr. Kaufmann
6	220	Marilyn Sparber	791-6938	Mr. Kaufmann
6	220	Felicia Katz	791-9501	Mr. Kaufmann
6	220	Donna Lobell	791-4568	Mr. Kaufmann
*6	220	Elaine Sandler	791-5765	Mr. Kaufmann
6	220	Barbara Smerling	791-2540	Mr. Kaufmann
6	217	Barbara Spetalnick	791-3389	Mrs. Melnick
6	217	Jeanette Barkolas	791-5334	Mrs. Melnick
6	217	Andrea Port	791-1358	Mrs. Melnick
6	217	Beth Greenwald	791-7509	Mrs. Melnick
6	217	Harriet Drucker	791-6452	Mrs. Melnick
6	217	Ruth Clayman	791-3934	Mrs. Melnick
6	217	Florence Tobis	791-6223	Mrs. Melnick

*Grade Co-ordinator

AUGUST 1978

SUNDAY	MONDAY	TUESDAY	WEDNESDAY	THURSDAY	FRIDAY	SATURDAY
know what being a good man ...? It means being better than ...ly are—so that even failures ... someone a little further to —Frederick Pohl		1	2	3	4	5
6	7	8	9	10	11	12
13	14	15 C.H.S. Bd. of Ed. Mtg., 8:00 P.M.	16	17	18	19
20	21	22	23	24	25	26
27	28	29	30	31	The camel is the result obtained when a committee attempted to create the horse. —Unknown	

VALLEY STREAM HIGH SCHOOL

VALLEY STREAM, NEW YORK

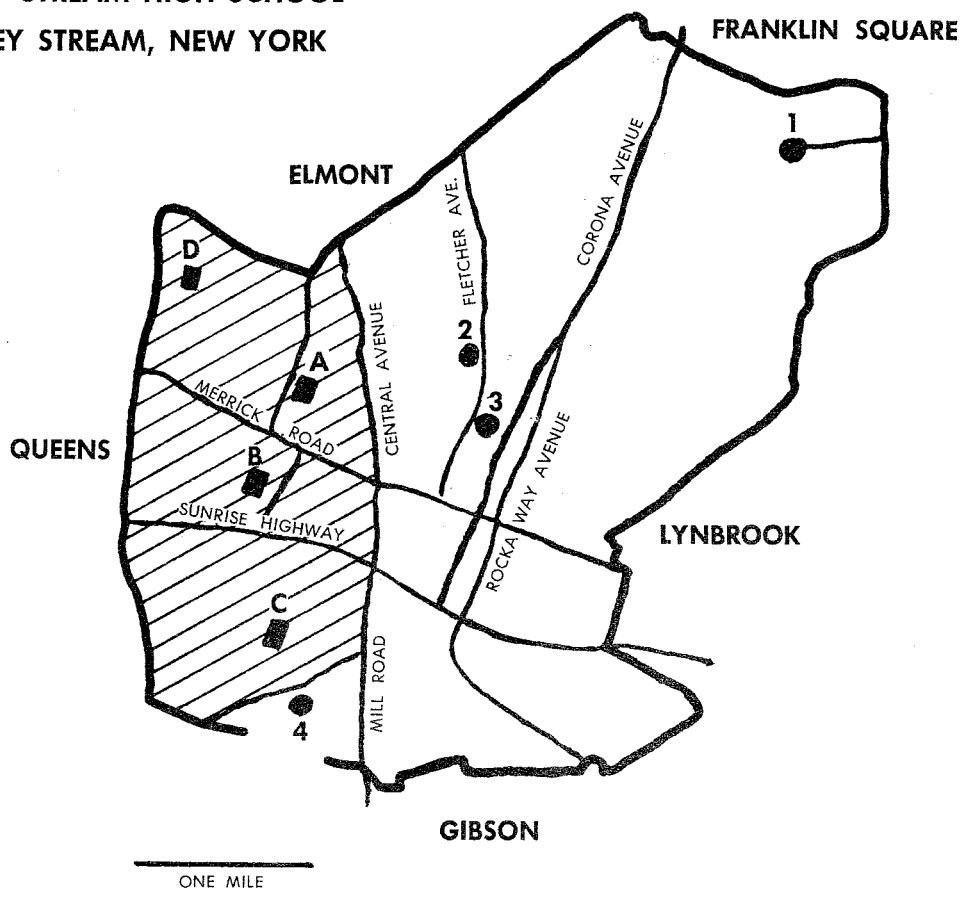

DISTRICT No. 30 SCHOOLS

- Shaw Avenue A
- Clear Stream Avenue B
- Forest Road C
- Washington Avenue D

Shaded Area — District 30

HIGH SCHOOLS

- North High 1
- Memorial Junior 2
- Central High 3
- South High 4

SCHOOL TELEPHONE DIRECTORY

OFFICE: SHAW AVENUE SCHOOL
 Principal VA 5-9131
 Office VA 5-9131
 Manager VA 5-9131

Shaw Avenue School
 Principal's Office VA 5-9131
 Nurse's Office VA 5-9131

Washington Avenue School
 Principal's Office VA 5-3044
 Office VA 5-3044

Washington Avenue School
 Office VA 5-9131

Special Services
 Psychologist VA 5-9131
 Speech Consultant VA 5-9131
 Reading Consultant PY 1-7676
 Audio-Visual Consultant LO 1-1165

Forest Road School
 Principal's Office PY 1-7676
 Office PY 1-7676

INDEX

- Board of Education and School Calendar see October
- Administration and Special Services see November
- Clear Stream PTA see December
- Shaw and Washington Ave. PTA see January
- Forest Road PTA see February
- Dev. of Percept. Skills see March
- The Teaching of Responsibility see April
- School Policies see May and June
- Shaw and Washington Class Mothers see July
- Clear Stream and Forest Class Mothers see August
- Map of the District see facing page

VALLEY STREAM HIGH SCHOOL
 Telephone Number: 824-2073
 Use this number for all high school buildings, offices and personnel

NOTES

VALLEY STREAM UNION FREE SCHOOL
DISTRICT THIRTY

30

SCHOOL ACTIVITIES

Calendar

FOR 1977 - 1978

PUBLISHED BY THE BOARD OF EDUCATION

AND PARENT-TEACHER ASSOCIATIONS

VALLEY STREAM UNION FREE SCHOOL
DISTRICT THIRTY

30

SCHOOL ACTIVITIES

Calendar

FOR 1978 - 1979

PUBLISHED BY THE BOARD OF EDUCATION AND PARENT-TEACHER ASSOCIATIONS

TELEPHONE DIRECTORY

INDEX

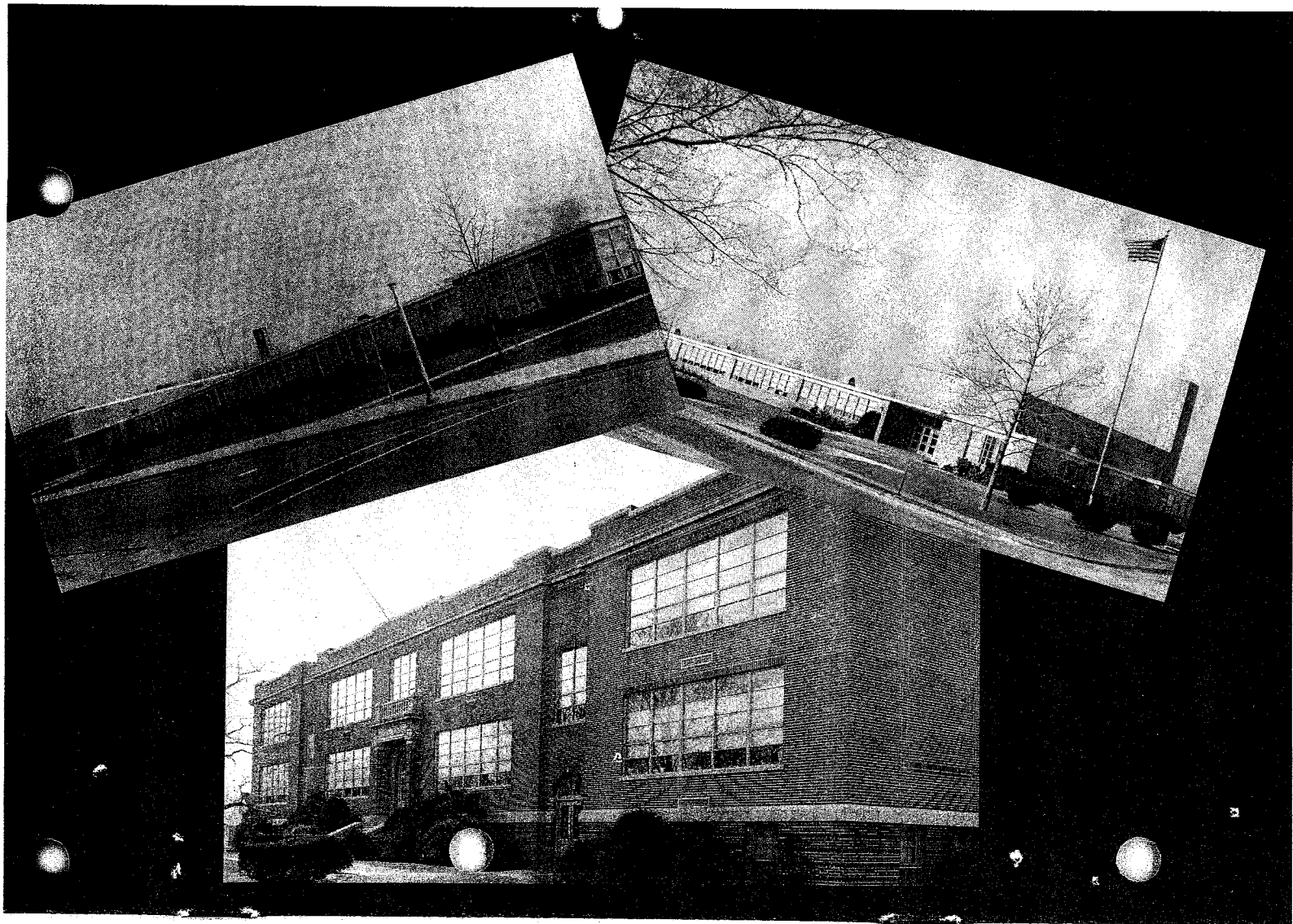

SEPTEMBER 1978

SUNDAY	MONDAY	TUESDAY	WEDNESDAY	THURSDAY	FRIDAY	SATURDAY
					1	2
3	4 LABOR DAY	5 FACULTY MEETING	6 SCHOOL OPENS	7 PTA Ex. Bd. Mtg., Clear Stream, 9:30 a.m.	8	9
10	11 Grs. 4, 5 & 6 Jr. Bowling Mtg., Shaw, 3:00 p.m.; PTA Gym Suit Sale, Forest, 2:45 p.m.	12 C.H.S. Bd. of Ed. Mtg., 8:00 p.m.; PTA Gym Suit Sale, Forest, 2:45 p.m.	13 Children's Bowling Mtg., for parents and children, Forest, 8:00 p.m.	14 Parents' Night, (Grs. K-3), Shaw, 8:15 p.m. PTA Bowling Begins, Shaw	15	16
17	18 Jr. Bowling Begins, Shaw	19 PTA Bowling Begins, Clear Stream: Meet the Teacher Nite, Forest, 8:15 p.m.	20 PTA Gen. Mtg., & Parents' Night, (Grs. K-3) Clear Stream, 7:30 p.m.; PTA Ex. Bd. Mtg., Shaw, 8:00 p.m.	21 PTA Gen. Mtg., & Parents' Night, (Grs. 4-6), Clear Stream, 7:30 p.m.; Parents' Night (Grs. 4-6), Shaw, 8:15 p.m.	22	23 Bowling for 5th & 6th Grs. Begins, Forest
24	25	26 Dist. No. 30 Bd. of Ed. Mtr	27	28	29	30

SCHOOL ADMINISTRATION

Dr. William T. Callahan, *District Superintendent*
 William J. Van Ness
Superintendent of Schools

SCHOOL PRINCIPALS

CLEAR STREAM AVENUE SCHOOL
 Richard M. Burbell

FOREST ROAD SCHOOL
 Maurice E. St. Mary

SHAW AVENUE SCHOOL
 Lawrence Cid

SCHOOL SECRETARIES

Connie Deering, Clear Stream Avenue
 Anna Docar, Shaw Avenue
 Stella Schlaeger, Forest Road

DISTRICT SECRETARIAL STAFF

Robert Bradley
 Mabel Hom
 Mary Ribando
 Lillian Ging
 Jean Annona

Evelyn Pearn, *Cafeteria Manager*

DISTRICT SPECIALISTS AND SPECIAL TEACHERS

Frank DeMarco, Director of Educational Communications
 Rosalyn Kessler, Psychologist
 Estelle Friedman, Psychologist
 Sharon Schulman, Speech Teacher
 Robin Hananel, Speech Teacher
 Henry Kohlmann, Instrumental Music Teacher
 Barbara Wieder, Instrumental Music Teacher
 Andrea Eden, Learning Disabilities Teacher

OTHER SPECIALISTS AND SPECIAL TEACHERS

Clear Stream Avenue School

Verna Hearn, Special Counselor
 Jeanne Colton, Reading Specialist
 Grace Giacobone, Art
 Philip Hessemer, Physical Education
 Joan Henningsen, Physical Education
 Linda Pratt, Music
 Ruth Newman, Library Media Specialist
 Eileen Limoncelli, Nurse

Forest Road School

Helen Fink, Special Counselor
 Ada Keane, Reading Consultant
 Eileen Goldsmith, Art
 Alfred Stevens, Physical Education
 Joan Henningsen, Physical Education
 Frances Gibson, Music
 Anita Strelisker, Library Media Specialist
 Hilda Rosenfeld, Nurse-Teacher

Shaw Avenue School

Noel Giambalvo, Special Counselor
 Janet Poppe, Reading Specialist
 Rosemary Williams, Reading Teacher
 Linda Muckle, Art
 Pamela Trimes, Art
 Thomas Rouse, Physical Education
 Joan Stein, Physical Education
 Kathryn Egan, Music
 Barbara Briker, Music
 Sylvia Berkowitz, Library Media Specialist
 Eileen Corcoran, Nurse

NOVEMBER 1978

SUNDAY	MONDAY	TUESDAY	WEDNESDAY	THURSDAY	FRIDAY	SATURDAY
<p>Nothing is easier than fault-finding; no talent, no denial, no brains, no character are required to set up in the grumbling business. —Robert West</p> <p>You expect perfection from people, your whole life is a series of appointments, grumblings and complaints. If, on the contrary, you set your expectations low, taking folks as the inefficient creatures which they are, you are frequently surprised by having them perform better than you had hoped. —Bruce Barton</p>			1	2	3	4
5	6	7	PTA Ex. Bd. Mtg., Forest, 8:00 p.m.	PTA Ex. Bd. Mtg., Clear Stream, 9:30 a.m.		
		ELECTION DAY SCHOOL OPEN	8	9	10	VETERAN'S DAY
12	13	14	15	16	17	18
	American Education Week Begins	PTA Gen. Mtg. Drug Prog. Forest, 8:15 p.m. C.H.S. Bd. of Ed. Mtg., 8:00 p.m.	<i>2022-11-15 mark</i>	PTA Gen. Mtg., Clear Stream, 8:00 p.m.	PTA Social Night, Shaw, 8:00 p.m.	
19	20	21	22	23	24	25
			FULL DAY SCHOOL	THANKSGIVING DAY SCHOOL CLOSED	SCHOOL CLOSED	
26	27	28	29	30	Two caterpillars were crawling across the grass when a butterfly flew over them. They looked up, and one nudged the other and said: "You couldn't get me up in one of those	
		Dist. No. 30				

CLEAR STREAM AVENUE PARENT TEACHER ASSOCIATION

ELECTED OFFICERS 1978-1979

<i>Co-Presidents</i>	Eileen Calandrino	825-6470
	Lenore Vita	285-5394
<i>1st Vice President</i>	Rosemary Smith	561-8667
<i>2nd Vice President</i>	Carol Gergel	285-8519
<i>Treasurer</i>	Tommy Fonte	872-0148
<i>Membership</i>	Faith Breiner	285-9087
<i>Recording Secretary</i>	Fran Gentile	872-3206
<i>Corresponding Secretary</i>	Roseann Petruzillo	285-4795
<i>Delegates to Council</i>	Marge Rollo	825-0929
	Jean Sivillo	
	Lillian Guberman	Faculty
<i>Past Presidents</i>	Sue Farrell	872-8026
	Kay McDonald	825-3313

COMMITTEE CHAIRMEN

<i>Arts & Flyers</i>	Amelia Pascocello	872-3119
<i>Audio-Visual</i>	Frank DeMarco	Faculty
<i>Budget</i>	Sue Farrell	872-8026
<i>Cultural Arts</i>	Rosemary Smith	561-8667
	Sandy Henry	825-6572
<i>Distribution</i>	Kay Ciccone	Lo 1-9207
<i>Health</i>	Emily Giganti	285-8432
<i>Historian</i>	Kay McDonald	825-3313
<i>Hospitality</i>	Florence Volpe	872-3517
<i>Legislation</i>	Lois Barry	285-8654
<i>Pre-School</i>	Carol Gergel	285-8519
<i>Publicity</i>	Cheryl Holton	561-9055
<i>School & Community</i>	Barbara Parisi	825-3214
<i>Streamer</i>	Theresa Benedetto	285-5410
<i>Sunshine</i>	Madeline Weiss	825-1719
<i>Ways & Means</i>	Rosemary Smith	561-8667
<i>Bowling President</i>	Roseann Petruzillo	285-4795
<i>Secretary</i>	Maureen Tkacsik	285-5582
<i>Treasurer</i>	Dottie Walz	825-8011
<i>Junior Bowling</i>	Al Angerthal	872-8252
<i>Grade Rep. Chairman</i>	Terry Keller	285-7016
<i>Kindergarten Gr. Rep.</i>	Pat Torres	285-5676
<i>1st Grade Rep.</i>	Maureen Kelly	872-6725
<i>2nd Grade Rep.</i>	Marion Acquavella	825-2272
<i>3rd Grade Rep.</i>	Faith Breiner	285-9087
<i>4th Grade Rep.</i>	Gerry Sullivan	561-8694
<i>5th Grade Rep.</i>	Ann Prisco	285-5744
<i>6th Grade Rep.</i>	Cheryl Holton	561-9055

P.T.A. PROGRAM

Sept.	7	Executive Board Meeting, 9:30 a.m.
	19	PTA Bowling Begins
	20	PTA General Meeting & Parents' Night 7:30 p.m. (K-3)
	21	PTA General Meeting & Parents' Night 7:30 p.m. (4-6)
Oct.	5	Executive Board Meeting, 9:30 a.m.
	12	Jelly Apple Sale, 2:45 p.m.
	13	Jelly Apple Sale, 2:45 p.m.
	31	5th and 6th Grade Halloween Party, 7:30 p.m.
Nov.	2	Executive Board Meeting, 9:30 a.m.
	16	PTA General Meeting, 8:00 p.m.
Dec.	7	Executive Board Meeting, 9:30 a.m.
	14	Pre-School Meeting, 1:30 p.m. (Parents of 4 yr. olds), PTA Holiday Boutique, 2:45 p.m.
	15	Clear Stream Music Program, 1:30 p.m. PTA Holiday Boutique, 2:45 p.m.
	22	PTA Holiday Program, 1:30 p.m.
Jan.	4	Executive Board & General Meeting, 9:30 a.m.
	8	Family Living Program 5th & 6th Gr. Parents, 7:30 p.m.
	9	Family Living Program 6th Grade Children, 3:00 p.m.
	11	Family Living Program Rap Session for 6th Grade Children, 3:00 p.m.
Feb.	1	Executive Board Meeting, 9:30 a.m.
	16	PTA Cake Sale, 2:45 p.m.
Mar.	1	Executive Board Meeting, 9:30 a.m.
	9	Father, Son & Daughter Night, 7:30 p.m.
	15	Pre-School Meeting, 1:30 p.m. (Parents of 4 yr. olds)
	22	PTA General Meeting, 8:00 p.m.
	26	District #30 Concert, 1:30 p.m.
April	5	Executive Board Meeting, 9:30 a.m.
	6	Music Program Spring Melodies, 8:00 p.m.
	26	Voters' Registration 7-9 a.m.—4-9 p.m. Art Show 7:30 p.m.
	27	Teachers' Recognition Day Luncheon, 11:15 a.m.
	28	PTA Vision Screening, 9:00 a.m.
May	3	Executive Board Meeting, 9:30 a.m. Hygiene Film 4th Gr. Girls, 3:00 p.m.
	10	Mothers' Day Boutique, 2:45 p.m.
	11	Mothers' Day Boutique, 2:45 p.m.
	17	Installation, 8:00 p.m.
June	7	Joint Executive Board Meeting, 9:30 a.m.
	15	Clear Stream Awards Assembly

DECEMBER 1978

NDAY	MONDAY	TUESDAY	WEDNESDAY	THURSDAY	FRIDAY	SATURDAY	
	Howlers Anonymous					1	2
	Teachers never cease to marvel at the ingenuity some students display in answering test questions. Here are a few, a test in science and mathematics, quoted in the January issue of the NEA Journal. The theory of evolution was greatly objected to because it made men think. The process of turning steam into water again is called conversation. The earth makes a resolution every twenty-four hours. Algebra was the wife of Euclid.						
3	4	5	6	7	8	9	
	PTA Council Mtg., Buck, 7:45 p.m.		PTA Ex. Bd. Mtg., Forest, 8:00 p.m.	PTA Ex. Bd. Mtg., Clear Stream, 9:30 a.m.			
10	11	12	13	14	15	16	
	Pre-School Mtg., Shaw, 3:00 p.m.	C.H.S. Bd. of Ed. Mtg., 8:00 p.m.; PTA Holiday Boutique, Forest, 2:45 p.m.	PTA Holiday Boutique, Shaw; PTA Holiday Boutique, Forest, 2:45 p.m.	Pre-School Mtg., Clear Stream, 1:30 p.m.; PTA Holiday Boutique, Clear Stream, 2:45 p.m.	Holiday Choral Assembly, Shaw; PTA Holiday Boutique, Clear Stream, 2:45 p.m.; Music Program, Clear Stream, 1:30 p.m.		
17	18	19	20	21	22	23	
		Dist. No. 30 Bd. of Ed. Mtg., 8:15 p.m.	PTA Ex. Bd Mtg., Shaw, 8:00 p.m.		PTA Holiday Program, Clear Stream, 1:30 p.m.		
24	25	26	27	28	29	30	
	CHRISTMAS						

SHAW AVENUE PARENT TEACHER ASSOCIATION

ELECTED OFFICERS 1978-1979

Marianne Bono	285-6405
Elaine Mosea	825-0414
Cathy Barbara	825-8469
Lois Patranzino	285-5102
Carol Blankshine	825-3119
Vera Manzo	872-8717
Angela Rodi	285-4951
Miriam Sweet	Faculty
Marie Verriello	285-5171
Pat Soltero	285-6373
Elaine Kelly	825-0113

COMMITTEE CHAIRMEN

Mr. J. Giacalone	Faculty
Mary Zeiner	285-9898
Kathy Giannico	285-4932
Vera Manzo	872-8717
Marie Balducci	872-0173
Pat Fox	872-3329
Cathy Pellergrino	285-5764
Marie Perozzi	285-6447
Jean Herzner	285-9368
Pina Tarsia	561-6507
Mary Ann Kass	825-8153
Undine Kaufman	285-8710
Ann Bochichio	285-7865
Angela Maglione	825-7440
Elaine Kelly	825-0113
Pat Soltero	285-6373
Carol Blankshine	825-3119
Marie Prete	285-5520
Nancy Hiner	285-4857
Angela Rodi	285-4951
Marie Verriello	285-5171
Edwina Matteo	285-9795
Vera Manzo	872-8717
Nancy Daly	285-6058
Elaine Mosca	825-0414
Cathy Barbara	285-8469

(Boutiques, Cupcake Sale, Shirt Sale, Fashion Show)

P.T.A. PROGRAM

Sept. 11	4th, 5th and 6th Grade Jr. Bowling Meeting, Shaw, 3:30 p.m.
14	Parents Night, Shaw (Grades K-3), 8:15 p.m.
14	PTA Bowling Starts
18	Jr. Bowling Starts
20	PTA Board Meeting, Shaw, 8:00 p.m.
21	Parents Night, Shaw (Grades 4-6), 8:15 p.m.
30	PTA Flea Market
Oct. 13	Shirt Sale, Shaw
18	PTA Board Meeting, Shaw, 8:00 p.m.
Nov. 17	PTA Social Night, Shaw, 8:00 p.m.
29	PTA Board Meeting, Shaw, 8:00 p.m.
Dec. 11	Pre-School Meeting, Shaw
13	PTA Holiday Boutique, Shaw
20	PTA Board Meeting, Shaw, 8:00 p.m.
Jan. 17	Cupcake Sale, Shaw
24	PTA Board Meeting, Shaw, 8:00 p.m.
Feb. 8	PTA Founders Night, Shaw
14	PTA Board Meeting, Shaw, 8:00 p.m.
Mar. 5	Pre-School Meeting, Shaw, 3:00 p.m.
14	PTA General Meeting, Shaw, 8:15 p.m.
29	PTA Fashion Show, Shaw
Apr. 25	PTA Volunteers Meeting, Shaw, 8:15 p.m.
28	Vision Screening, Shaw
May 9	Mothers Day Boutique, Shaw
14	Pre-School Meeting, Shaw, 3:00 p.m.
23	Teachers Recognition Day, Shaw
24	PTA General Meeting, Installation, 8:00 p.m.
June 6	PTA Joint Board Meeting, Shaw, 8:00 p.m.
13	Fathers Day Boutique, Shaw

JANUARY 1979

SUNDAY	MONDAY	TUESDAY	WEDNESDAY	THURSDAY	FRIDAY	SATURDAY
	1 NEW YEAR'S DAY SCHOOL CLOSED	2 SCHOOL REOPENS	3 PTA Ex. Bd. Mtg., Forest, 8:00 p.m.	4 PTA Ex. Bd. & Gen. Mtg., Clear Stream, 9:30 a.m.	5	6
7	8 Family Living Program, 5th & 6th Gr. Parents, Clear Stream, 7:30 p.m.	9 C.H.S. Bd. of Ed. Mtg., 8:00 p.m.; Family Living Program, 6th Gr. Children, Clear Stream, 3:00 p.m.	10	11 Family Living Program, Rap Session, 6th Gr. Children, 3:00 p.m.	12	13
14	15	16 PTA Gen. Mtg., "Discipline"! Forest, 8:15 p.m.	17 PTA Cupcake Sale, Shaw	18	19	20
21	22	23 Dist. No. 30 Bd. of Ed. Mtg., 8:15 p.m.	24 PTA Ex. Bd. Mtg., Shaw, 8:00 p.m.	25	26	
28	29	30	31	Do you recall when Edmund Hillary and his native guide, Tenzing, made their historic climb of Mt. Everest? Coming down from the peak Hillary lost his footing. Tenzing held the line taut and kept both from falling by digging his ax into the ice. Later Tenzing refused any special		

FOREST ROAD PARENT-TEACHER ASSOCIATION

ELECTED OFFICERS 1978-1979

President	Rochelle Koval	791-1232
Vice President	Gloria Feig	791-6315
Vice President	Judy Orloff	791-3820
Vice President	Joan Frishling	791-7663
Secretary	Marie Spiwak	791-3307
Secretary	Roz Scheidt	791-9468
Secretary	Rhoda Levine	791-3148
Secretary	Karen Bing	825-0105
Secretary	Linda Harris	791-7827
Secretary	Linda Jones	791-5816
Secretary	Lydia Rosen	791-5488

COMMITTEE CHAIRMEN

Amblyopia	Abby Tedesco	791-2157
Reading	Betty Sabbatini	791-8165
Reading	Elaine Sandler	791-5765
Reading	Ruth Bazil	791-8556
Reading	Linda Harris	791-7827
Reading	Betty Sabbatini	791-8165
Reading	Adrienne Eisner	791-3622
Reading	Sandy Train	791-8221
Reading	Marsha Langbart	791-8442
Reading	Rochelle Rubin	872-9270
Reading	Barbara Spetalnick	791-3389
Reading	Carol Mutterpearl	791-1060
Reading	Carol Provanzano	825-5915
Reading	Sima Pomerantz	791-4019
Reading	Harriet Schulman	791-7437
Reading	Linda Zahn	791-4516
Reading	Louise Wenzel	791-6354
Reading	Sharon Bohmer	791-5367
Reading	Helene Klein	791-1697
Reading	Arlene Panzer	791-3652
Reading	Sandy Alexander	791-7091
Reading	Pat Block	791-4920
Reading	Laura Hans	791-1764
Reading	Roz Scheidt	791-9468
Reading	Joan Frishling	791-7663
Reading	Carol Provanzano	825-5915
Reading	Karen Bing	825-0105
Reading	Felicia Katz	791-9501
Reading	Trena Danels	791-1506
Reading	Enid Parness	791-5960
Reading	Joan Frishling	791-7663
Reading	Dorothy Alperson	791-2284
Reading	Blossom Melnick	791-4568
Reading	Donna Lobell	791-4568
Reading	Judy Orloff	791-3820
Reading	Judy Azzolina	791-4785
Reading	Sue Baxter	791-6084
Reading	Phyllis Wolin	791-8120
Reading	Edna Crescas	791-5972
Reading	Marie Spiwak	791-3307

Gym Suit Sale
Board Listing
Teachers Recognition Day
Book Fair

PTA Luncheon

Paulette Kirschenbaum 791-7045
Chickie Heym 561-7237
Donna Lobell 791-4568
Audrey Chasen 791-8248
Lenora Paletz 791-5274
Betty Fine 791-1806
Alice Fischer 791-3824

P.T.A. PROGRAM

Sept.	11	Gym Suit Sale
	12	Gym Suit Sale
	13	Sign Up 5th & 6th Grade Bowling (Parents & Children) 8:00 p.m.
	19	Meet The Teacher Night
	22	5th & 6th Grade Bowling, 3:30 p.m.
Oct.	4	Executive Board Meeting, 8:00 p.m.
Nov.	1	Executive Board Meeting, 8:00 p.m.
	14	General Meeting Drug Program, 8:15 p.m. Pre-School Meeting
Dec.	6	Executive Board Meeting, 8:00 p.m.
	12	Holiday Boutique
	13	Holiday Boutique
Jan.	3	Pre-School Meeting
	3	Executive Board Meeting, 8:00 p.m.
	16	General Meeting, 8:15 p.m. Discipline
Feb.	7	Executive Board Meeting, 8:00 p.m. Pre-School
Mar.	6	Family Living
	7	Executive Board Meeting, 8:00 p.m.
	17	Carnival, 11:00 a.m.
	20	General Meeting, Election of Officers, Gym Show
Apr.	4	Pre-School
		Executive Board Meeting, 8:00 p.m.
	7	Bicycle Program
	27	Book Fair, 8:30-11:30 a.m., 1:00-3:30, 7:00-8:00 p.m.
May	2	Executive Board Meeting, 8:00 p.m.
	5	Amblyopia
	9	Plant Sale, 2:30
	15	PTA Installation of Officers General Meeting, 15 p.m. Music Show
	17	Teachers Recognition Day
June	6	Executive Joint Board Meeting, 8:00 p.m.
	14	PTA End of Year Luncheon, 12 Noon

FEBRUARY 1979

SUNDAY	MONDAY	TUESDAY	WEDNESDAY	THURSDAY	FRIDAY	SATURDAY
				1	2	3
by this is the ultimate postulate in a democracy: not that man is good, but that man is capable of good; not that he is free from corruption, but that he is desperately in need of it; not that he has fashioned the good society, but that he has caught an unflattering glimpse of it. —Unknown				PTA EX. Bd Mtg., Clear Stream, 9:30 a.m.		
4	5	6	7	8	9	10
		PTA Council Mtg., Carbannaro, 7:45 p.m.	PTA Ex. Bd. Mtg., Forest, 8:00 p.m.	PTA Founders' Day Program, Shaw For all Schools		
11	12	13	14	15	16	17
	LINCOLN'S BIRTHDAY	C.H.S. Bd. of Ed. Mtg., 8:00 p.m.	PTA Ex. Bd. Mtg., Shaw, 8:00 p.m.		PTA Cupcake Sale, Clear Stream, 2:45 p.m.	
18	19	20	21	22	23	24
	WINTER RECESS SCHOOL CLOSED	WINTER RECESS SCHOOL CLOSED	WINTER RECESS SCHOOL CLOSED	WINTER RECESS SCHOOL CLOSED WASHINGTON'S BIRTHDAY	WINTER RECESS SCHOOL CLOSED	
25	26	27	28	The development of a new product is a three step process: first, an American firm announces an invention; second, the Russians claim they made the same		

THE CLEAR STREAM AVENUE SCHOOL

was the year the townspeople of the west end of Valley decided that they wanted a school for their children. Mrs. Sanchez (who served our district for nearly fifty years as secretary) remembers the long walks that were necessary in order to attend the Brooklyn Avenue School every morning. The children, as well as the parents, were pleased when the Board decided to establish a District Thirty School.

Arthur Hendrickson remembered going with a committee of to the Popalvea home in Springfield Gardens to complete the The Clear Stream Avenue grounds. Prices of land began to around 1923, so \$25,000 an acre for the first two acres was agreed by both sides to be a fair price. The parcel of land being had been a farm which had not recently been tilled.

Clear Stream Avenue School planned was to have eight but obviously this undertaking could not be built overnight. Residents of the newly established district would meet in Mr. Ford's garage for their local civic affairs. All the cars would be parked in the street in order to make room.

A wooden frame building was first leased to District Thirty for temporary use. It had four rooms, two classes in a room, plus a boys' bathroom in the rear of the structure. In June of that year there were eight graduates from the newly formed district. Within the next year, classes were in the new building. The newly constructed 2 story brick building contained eight rooms, four on each

The name Clear Stream was used more often than the title Union School District 30. The name had come from the bountiful Clear Stream creek which ran not far behind the school. It was this creek which pumped over 3,500,000 gallons of water to the Brooklyn consumers beginning in 1885.

An addition to the main building added four rooms on the two floors. It was obvious that with the population influx in the nearby metropolitan area, that additional space would be needed. District Thirty trustees decided that the schools in the district need to be constructed to meet the growing pupil population throughout the school district. In the years that followed, the Shaw Avenue and Forest Road Schools were built. Building additions included a new wing in 1956 at The Clear Stream Avenue incorporating an auditorium/gymnasium, lunchroom and kindergarten room.

SHAW AVENUE SCHOOL

Prior to 1950 District Thirty consisted of one building, the Clear Stream Avenue School. The Shaw Avenue School was opened in September of 1950 and had an enrollment of approximately 680 pupils. The original building housed 18 classrooms, one art room, a small library, an auditorium, a gym-cafeteria, a second floor community room and a main office, which also served as the District Office.

Due to rapidly rising pupil enrollment, the school was soon too small to accommodate the children of the area, thus causing the school to go on double sessions. In 1956, six classrooms were added to the building and shortly thereafter 8 more classrooms and a gymnasium were constructed. During that same year, the Washington Avenue School was built as an annex to the Shaw Avenue School, consisting of two first grade rooms and a kindergarten room. Enrollment at the Shaw and Washington Avenue schools totaled about 1400 pupils during this period of time. Today, enrollment has declined to approximately 600 pupils.

The Shaw Avenue School has always been a special pride to its community as is reflected by the significant number of former students who have returned to the area as adults so that their children may attend "their school."

FOREST ROAD SCHOOL

Forest Road School opened in September 1953, with thirteen classrooms, a gym, cafeteria, Teacher's Room, Nurse's office and main office. There were 373 pupils in attendance that September. Previous to 1953, these pupils had attended Clear Stream Avenue School.

Enrollments kept rising so that in 1956 a new wing was added to the school which included nine additional classrooms, a library, and an office for consultants. At this time there were 582 pupils in attendance. The peak enrollment was in 1958-59 when attendance rose to 685 pupils. From that year on, the number of youngsters has continued to decline gradually so that in 1977-78, there were 226 pupils in attendance.

Statistics aside, Forest Road pupils have always done well academically. In fact, on the State PEP Tests, as an individual school, it ranks among the highest in New York State. Graduates of Forest Road are now mostly professional people—doctors, dentists, lawyers, teachers, etc.

This year being the 25th year for the school, steps are being taken to have a celebration and it is hoped that many of the previous graduates will be on hand to help with the party. If plans are carried through, we hope to be able to create a booklet giving current information about many of these graduates.

MARCH 1979

SUNDAY	MONDAY	TUESDAY	WEDNESDAY	THURSDAY	FRIDAY	SATURDAY
<p>by the reason God made woman last was because He didn't want any advice while man.</p> <p>Something that gets a lot of credit which really belongs to cold feet.</p> <p>looking at his son's report card sighed: "I'm afraid you're beyond even federal aid."</p>				<p>1</p> <p>"Lights On," Mem. Jr. High School; PTA Ex. Bd. Mtg., Clear Stream, 9:30 a.m.</p>	<p>2</p>	<p>3</p>
<p>4</p> <p>Pre-School Mtg., Shaw, 3:00 p.m.</p>	<p>5</p>	<p>6</p> <p>PTA Family Living Program, Forest</p>	<p>7</p> <p>PTA Ex. Bd. Mtg., Forest, 8:00 p.m.</p>	<p>8</p>	<p>9</p> <p>Father, Son, Daughter Night, Clear Stream, 7:30 p.m.</p>	<p>10</p>
<p>11</p>	<p>12</p>	<p>13</p> <p>PURIM C.H.S. Bd. of Ed. Mtg., 8:00 p.m.</p>	<p>14</p> <p>PTA Gen. Mtg., Shaw, 8:15 p.m.</p>	<p>15</p> <p>Pre-School Mtg., Clear Stream, 1:30 p.m.</p>	<p>16</p>	<p>17</p> <p>ST. PATRICK'S DAY PTA Carnival, Forest, 11:00 a.m.</p>
<p>18</p>	<p>19</p>	<p>20</p> <p>PTA Gen. Mtg., Gym Show, Forest</p>	<p>21</p>	<p>22</p> <p>PTA Gen. Mtg., Clear Stream, 8:00 p.m.</p>	<p>23</p>	<p>24</p>
<p>25</p>	<p>26</p>	<p>27</p> <p>Dist. No. 30 Bd. of Ed. Mtg.,</p>	<p>28</p>	<p>29</p> <p>PTA Fashion Show.</p>	<p>30</p> <p>Dist. Music Concert.</p>	<p>31</p>

Though the following refers to "teacher," it is our feeling that the concepts expressed apply as well to the parent-child relationship.

A STUDENT'S REQUEST OF HIS TEACHER

- Don't be afraid to be firm with me. I prefer it; it makes me feel more secure.
- Don't make me feel smaller than I am. It makes me behave stupidly "big."
- Don't correct me in front of others if you can help it. I'll take much more notice, if you talk quietly with me in private.
- Don't make me feel my mistakes are sins. It upsets my sense of values.
- Don't protect me from consequences. I need to learn the painful way sometimes.
- Don't take too much notice of my complaints. Sometimes they get me the attention I need.
- Don't nag. If you do, I'll protect myself by appearing deaf.
- Don't make rash promises. Remember, I feel badly let down when promises are broken.
- Don't forget that I cannot explain myself as well as I'd like. This is why I'm not always very accurate.
- Don't tax my honesty too much. I'm easily frightened into telling lies.
- Don't be inconsistent with me. That completely confuses me and makes me lose faith in you.
- Don't put me off when I ask questions. If you do, I'll stop asking and seek information elsewhere; then I'm labeled a behavior problem.
- Don't label me. For, whatever you think of me, there'll be a tendency for me to become.
- Don't ever suggest that you're perfect and infallible. It gives me too great a shock when I discover that you're neither.
- Don't tell me my fears are silly. They're terribly real and you can do much to reassure me if you try to understand.
- Don't ever think it's beneath your dignity to apologize to me. An honest apology makes me feel surprisingly warm toward you.
- Don't forget I can't strive without lots of understanding and love; but I don't need to tell you, do I?

Reprinted from *The Learning and Behavior Bulletin*
 Learning and Counseling Center, Stockton, California

APRIL 1979

SUNDAY	MONDAY	TUESDAY	WEDNESDAY	THURSDAY	FRIDAY	SATURDAY
1	2 PTA Council Mtg., Forest, 7:45 p.m.	3	4 PTA Ex. Bd. Mtg., Forest, 8:00 p.m.	5 PTA Ex. Bd. Mtg., Clear Stream, 9:30 a.m.	6 Spring Melodies, Clear Stream, 8:00 p.m.; Choral Program, Assembly and Evening, Shaw	7 PTA Bicycle Program, Forest
8 SUNDAY	9	10 C.H.S. Bd. of Ed. Mtg., 8:00 p.m.	11	12 FIRST DAY OF PASSOVER HOLY THURSDAY EASTER RECESS SCHOOL CLOSED	13 SECOND DAY OF PASSOVER GOOD FRIDAY EASTER RECESS SCHOOL CLOSED	14
15 SUNDAY	16 EASTER RECESS SCHOOL CLOSED	17 EASTER RECESS SCHOOL CLOSED	18 EASTER RECESS SCHOOL CLOSED SEVENTH DAY OF PASSOVER	19 EASTER RECESS SCHOOL CLOSED EIGHTH DAY OF PASSOVER	20 EASTER RECESS SCHOOL CLOSED	21
22	23 SCHOOL REOPENS	24 Dist. No. 30 Bd. of Ed. Mtg., 8:15 p.m.	25 PTA Volunteers Mtg., Shaw, 8:15 p.m.	26 Art Exhibit, Shaw, 7:30 p.m. to 9:00 p.m. Reg. for Budget Vote, Each School, 7-9 a.m.; 4-9 p.m.	27 Teacher Recognition Day Luncheon, Clear Stream; PTA Book Fair, Forest, 8:45-11:30 a.m.; 3:30-8:00 p.m.	28 PTA Vision Screening, Clear Stream & Shaw
29	30 Art Exhibit, Clear Stream, 7:30 p.m.-9:00 p.m.	Children, like watches, must not be constantly wound up—you must let them run. Someone once said that school is the mouse race that equips you for the rat race. —Eugene P. Bertin in <i>Pennsylvania School Journal</i> * * * * * Some children are budding delinquents even when quite young. Child Hoods, so to speak. —from <i>Changing Times</i> * * * * *				

SCHOOL POLICIES

SCHOOL HOURS

hours for grades 1, 2, and 3 are from 9:00 a.m. to 3:00 p.m.
hours for grades 4, 5, and 6 are from 8:30 a.m. to 2:45 p.m.

LUNCH

is served beginning with the first day of school. Pupils may go for lunch, bring lunch from home, or buy the school lunch in cafeteria for 50c. Monthly menus are provided so that if foods served which your child does not eat, you can make other provisions for him for those days. In case a child forgets his lunch money or loses either, we have a charge system to cover the expense except the week before a recess and summer vacation. The cashier in the cafeteria keeps the record of such charges and the parents should a charge not be paid in a reasonable time.

ICE CREAM

Ice cream is sold daily to those pupils who wish it. It is *not* part of the school lunch and costs an additional 15c.

RECESS MILK

Recess milk is available to all children beginning about the third week of the school year and is sold at a cost of 50c per week payable each Friday for the following week. You will be notified as to exact amount. Money brought in late (Friday) cannot be accepted. In case of a child's absence, no refund is made for periods of less than a full week.

ABSENCES

If your child has been absent, State law requires that he bring a note from you explaining the absences and the date(s) of absence(s). A note should be presented to the nurse *before* he goes to the school room. Please be specific. Just saying, "he was ill," is not enough. Indicate whether it was "virus," "fever," "cold," etc. A note is required for an absence due to a religious holiday. A note is required for any tardiness, giving the reason. If your child contracts a contagious disease, such as mumps, measles, etc., please phone the school nurse so that she can alert the parents in your child's class that other children have been exposed. Be sure to keep the emergency card up to date so that we will know whom to call should your child become ill and have to go home.

NOON HOUR RULES

When pupils misbehave in the cafeteria, auditorium, or on the playground during the noon hour, after repeated reminders, the teachers have the authority to exclude them from staying in school for lunch for a few days, or longer, depending on the misbehavior. If you receive such a note from us, we would appreciate your cooperation. Whether or not a mother is home during the noon hour has no bearing on this exclusion.

RELEASED TIME FOR RELIGIOUS INSTRUCTION

A Release Form signed by the parent is necessary should you want your child excused from school for religious instruction. Such forms can be obtained from your church. The time provided is the last hour of school on Wednesday afternoons.

EXITS AND ENTRANCES

Your child's class is assigned a specific exit and entrance to use. You will thus know where to meet him if you come to pick him up. Parents picking up children are asked to meet them at the exit, *not* the classroom.

ENTRANCE TIMES

Morning—All Schools	Noontime—Shaw & Forest
Grades 1, 2, & 3—8:50	Grades 1, 2, & 3—12:50
Grades 4, 5, & 6—8:20	Grades 4, 5, & 6—12:20
Noontime—Clear Stream: Grades 5 & 6—12:05	
Grades 3 & 4—12:35; Grades 1 & 2— 1:05	

Because there is no supervision of the playground in the morning, we suggest you arrange your child's departure from home to allow him to arrive just in time to enter the building during the proper interval. In inclement weather he may come into the designated area five minutes before the above times.

CLASS INTERRUPTIONS

No unnecessary interruptions of classes are allowed once the day's sessions have begun. When your child forgets a book, homework, sneakers, lunch money, etc., please bring these to the office. All pupils are instructed to check with the office at lunch time for such forgotten items. In the interest of the child's all-round education, we urge you not to make a practice of bringing forgotten items to school. The child should be developing his own sense of responsibility for these things.

MAY 1979

FRIDAY	MONDAY	TUESDAY	WEDNESDAY	THURSDAY	FRIDAY	SATURDAY
boys on my baseball team go into and never come out of them, and I've tears snap right out of it and come back again ever. I guess more players lick than are ever licked by an opponent. The first thing a man has to know is to handle himself. —Connie Mack	1	2	3	4	5	6
	7	8	9	10	11	12
	13	14	15	16	17	18
19	20	21	22	23	24	25
26	27	28	29	30	31	MEMORIAL DAY
						People can be divided into three groups: those who make things happen, those who watch things happen, and those who wonder what happened. —John W. Newbern

SCHOOL POLICIES

GYM SUITS AND SNEAKERS

Gym suits are required of pupils below the 3rd grade, but sneakers are necessary for any pupils using the gym. Boys and girls from the through 6th grades are required to wear gym suits and sneakers on assigned gym days. The gym teachers will explain this to the parents. Many times they do not bring the correct information.

Who **MUST PURCHASE A NEW SUIT** should buy the two-piece **ROYAL BLUE**, bloomer type, with elastic bottoms, or **ROYAL BLUE** shorts with elastic insert in the cuff, and a white t-shirt. Boys should wear **ROYAL BLUE** shorts, with elastic top, and white socks (high top ones preferred), and white or **SCHOOL "T"** shoes.

IF A CHILD HAS ANOTHER COLOR, OR TYPE, HE DOES NOT HAVE TO BUY A NEW ONE. The above apparel may be purchased at many local stores in Valley Stream. **NO ONE IS ALLOWED ON THE GYM FLOOR WITHOUT SNEAKERS.**

APPOINTMENTS WITH TEACHERS

Remember that pupils' classtime be used to the fullest advantage, we request that parents do not seek conferences with teachers during school hours. If you wish a conference, please make an appointment with the teacher after school. Teachers are available for such conferences every day except Wednesdays and Fridays.

BICYCLES

Bicycles are allowed at either Forest Road or Clear Stream Elementary Schools because no child lives far enough from the school to need them necessary. They are allowed at Shaw, but are restricted to pupils in grades 4, 5, and 6 who live **NORTH OF FOSTER AVENUE**. Bicycles used to come to the Shaw Avenue School will be numbered. All must have a lock and chain for safety purposes.

GIFTS TO TEACHERS PROHIBITED

Policy of the school district which became effective January 1, 1979, is to prohibit the acceptance of gifts by faculty members on school premises, and to prohibit the solicitation of funds for personal purposes, by any person, or persons, on the premises.

IN-DAY PROGRAM

In inclement weather, there is an in-day program of motion pictures or quiet games provided for those pupils who eat in the cafeteria. Pupils who go home to lunch are not allowed to participate in this program because of space limitations, so we ask parents to return these pupils to school on such days just in time for the afternoon session—not before 12:50 p.m. for grades 1 to 3, and 12:20 p.m. for grades 4 to 6 at Shaw and Forest; and not before 12:05 p.m. for grades 5 and 6, 12:35 p.m. for grades 3 and 4, and 1:05 p.m. for grades 1 and 2 at Clear Stream.

HOMEWORK REQUIREMENTS

Homework is required of all pupils, but it will vary from day to day. First and second grade pupils may have fifteen to twenty minutes of homework per day, while third and fourth grade pupils are likely to have thirty to forty minutes. Fifth and sixth graders are expected to devote as much as an hour to homework, but again this may not be every day—it will depend on the pupil and his needs.

LOST AND FOUND

Unmarked articles lost by pupils are placed in the Lost-and-Found, which is in the Nurse's Office at Shaw & Forest, and the custodian's office at Clear Stream. Such articles, if not claimed at the end of the school year, are given to a charitable organization. However, any article bearing a child's name is returned directly to him. Please place your child's name on all his belongings.

STAYING AFTER SCHOOL

To eliminate any confusion or problems, the school may have your child every day for an additional half hour. During this half hour beyond the regular school day, the teacher may schedule your child for special help or keep him for any of several reasons. We ask that you keep this in mind and not schedule dental appointments, dancing lessons, etc., until after that interval. Teachers are also available to parents during the half hour after school, except on Wednesday and Friday, for conferences.

ASSEMBLIES

When your child's class puts on the assembly, we welcome your attendance, but we do ask you not to bring pre-school children. As much as we realize that it is a thrill for them to see big brother perform, they are often distracting to all concerned. Picture taking is not allowed without prior approval.

JUNE 1979

SUNDAY	MONDAY	TUESDAY	WEDNESDAY	THURSDAY	FRIDAY	SATURDAY
Young worker who had been loafing for most of the past year approached an older man just before he was to be reviewed for a raise. "Do you think," he asked anxiously, "that if I really work hard for the next two weeks, I'll get a raise?" "No," the older worker replied, "you make me think of a thermometer in a cold room. You can make the mercury rise higher by holding your hand over it, but you won't be warming the room."					1	2
3	4 String Recital, Shaw, 7:30 p.m. Field Day, Clear Stream	5 String Recital, Clear Stream, 7:30 p.m.	6 String Recital, Forest, 7:30 p.m. Field Day, Shaw PTA Joint Ex. Bd. Mtg., Shaw & Forest, 8:00 p.m.	7 PTA Joint Ex. Bd. Mtg., Clear Stream, 9:30 a.m.	8 Field Day, Forest	9
10	11 PTA Council Mtg., Memorial, 7:45 p.m.	12 C.H.S. Bd. of Ed. Mtg., 8:00 p.m.	13 Father's Day Boutique, Shaw	14 PTA End of Year Luncheon, Noon	15	16
17	18 Regents Week in the High Schools	19	20 Closing Exercises For Sixth Grades	* 21	* 22 LAST DAY OF SCHOOL YEAR	23
24	* 25	* 26 Dist. No. 30 Bd. of Ed. Mtn	* 27	* 28	* 29	30

SHAW AVENUE SCHOOL

CLASS MOTHER LIST

Class Mother Chairman..... Undine Kaufman, 285-8710

Room	Class Mother	Tel. Number	Teacher
Kindergarten Representative	Lucille Mazza	285-7926	
1 AM	Mrs. Vogt	872-0343	Mrs. Neary
1 PM	Mrs. Bochichio	285-7865	Mrs. Neary
2 PM	Mrs. Larow	825-2510	Mrs. Dankoff
1st Grade Representative	Carol Pesche	285-6223	
	Mrs. Mannino	285-4693	Mrs. Levine
	Mrs. Eversman	872-6975	Mrs. Lazar
	Mrs. Pesche	285-6223	Mrs. Hartman
2nd Grade Representative	Barbara Kankaris	285-8681	
	Mrs. Buono	825-2370	Mrs. Barra
	Mrs. Liberato	872-6938	Mrs. Graffigno
	Mrs. Chiano	285-7721	Miss Cohen
	Mrs. Rodi	285-4951	Miss Starler
3rd Grade Representative	Kathy Pellegrino	285-5764	
	Mrs. Brown	285-5161	Mrs. Sweet
	Mrs. Lupo	285-8930	Mrs. Strumpf
	Mrs. Pantranzino	285-5102	Mrs. Stuto
	Mrs. Brown	561-1156	Mrs. Federici

Gr. Room	Class Mother	Tel. Number	Teacher
4th Grade Representative	Elizabeth Collura	285-6289	
4 108	Mrs. Bono	285-6405	Mr. Carr
4 109	Mrs. Mosca	872-0414	Mrs. Benedetto
4 110	Mrs. Messina	285-9333	Mr. Riccobono
5th Grade Representative	Eileen Coughlin	825-2264	
5 116	Mrs. Delgado	872-0817	Miss Melzer
5 118	Mrs. Green	285-8499	Mrs. Hamcke
5 121	Mrs. Nickdow	285-4869	Mrs. Seid
5 122	Mrs. Michel	561-8094	Mr. Beyrer
6th Grade Representative	Camille Cecere	285-5579	
6 123	Mrs. Audino	285-6212	Miss Lanell
6 124	Mrs. Montano	561-0267	Mrs. Sherman
6 125	Mrs. Balducci	872-0173	Mrs. Haydock
6 127	Mrs. Giacalone	825-3845	Mr. Giacalone
Special Class	Mrs. Hoffman	825-3870	

JULY 1979

SUNDAY	MONDAY	TUESDAY	WEDNESDAY	THURSDAY	FRIDAY	SATURDAY
1	2	3	4	5	6	7
8	9	10	INDEPENDENCE DAY	12	13	14
15	16	17	C.H.S. Bd. of Ed. Mtg., 8:00 p.m.	19	20	21
22	23	24	25	26	27	28
29	30	31	Dist. No. 30 Bd. of Ed. Mtg., 8:15 p.m. (Tentative)			
<p>Summer is the time of year when children slam the doors they left open in winter!</p> <p style="text-align: center;">* * * *</p> <p>The man who trusts men will make fewer mistakes than he who distrusts them.</p> <p style="text-align: center;">* * * *</p>						

**CLEAR STREAM AVENUE SCHOOL
CLASS MOTHER LIST**

Class Mother Chairman

Grade	Room	Class Mother	Tel. Number	Teacher
K AM	9	Maureen Brigante	285-7361	Mrs. Murray
K AM	9	Pat Dalessio	872-6132	Mrs. Murray
K AM	9	Kathy Lane	561-6211	Mrs. Murray
K AM	9	Maureen Richford	825-6518	Mrs. Murray
K PM	9	Ruth Fiumaro	825-5055	Mrs. Murray
K PM	9	Teri Bonomo	285-6240	Mrs. Murray
K PM	9	Madelyn Schweigert	285-8823	Mrs. Murray
K PM	9	Cathy Wright	(212) 528-4268	Mrs. Murray
1	B	Carol Gergel	285-8519	Mrs. SchAAF
1	B	Mary Kajdacs	285-8457	Mrs. SchAAF
1	B	Rosemary Smith	561-8667	Mrs. SchAAF
1	B	Mary Lynch	285-9425	Mrs. SchAAF
1	OL	Barbara Clarke	872-8415	Mrs. Maclean
1	OL	Cheryl Kutich	872-0047	Mrs. Maclean
1	OL	Gerry Sullivan	561-8694	Mrs. Maclean
1	OL	Judy Trink	825-3123	Mrs. Maclean
1	7	Faith Breiner	285-9887	Mrs. Kalhofer
1	7	Maureen Kelly	872-6725	Mrs. Kalhofer
1	7	Marilyn Le Du	872-9644	Mrs. Kalhofer
1	7	Aggie Poli	285-8317	Mrs. Kalhofer
2	5	Chris Boudreau	872-0468	Mrs. Galati
2	5	Martha Evola	285-5158	Mrs. Galati
2	5	Barbara Hildenbrandt	872-3281	Mrs. Galati
2	5	Catherine Wright	528-4255	Mrs. Galati
2	6	Gail Barbato	285-9332	Mrs. Guberman
2	6	Egan	825-8975	Mrs. Guberman
2	6	Elaine Marshall	285-4650	Mrs. Guberman
2	6	Marge Rollo	825-0929	Mrs. Guberman
2	3	Marion Acquavella	825-2272	Mrs. Ruschin
2	3	Jean Geist	872-6446	Mrs. Ruschin
2	3	Sandy Henry	825-6572	Mrs. Ruschin
2	3	Joy Schuanhoff	872-9463	Mrs. Ruschin
3	1	Theresa Benedetto	285-5410	Miss Firpo
3	1	Diane Bruendl	285-7312	Miss Firpo
3	1	Carol Leggio	285-6222	Miss Firpo
3	1	Cathy Nelson	285-7648	Miss Firpo
3	2	Faith Briener	285-9087	Miss Schindelman
3	2	Carol Gergel	285-8519	Miss Schindelman
3	2	Barbara McLoughlan	825-4358	Miss Schindelman
3	2	Maureen Richford	825-6518	Miss Schindelman
3	4	Eileen Calandrino	825-6470	Mrs. Quinn
3	4	Arlene Ercole	285-8127	Mrs. Quinn
3	4	Marilyn Schneider	825-5350	Mrs. Quinn
3	4	Florence Volpe	872-3517	Mrs. Quinn
4	23	Donna Diana	825-5174	Miss Nanken
4	23	Jean Geist	872-6446	Miss Nanken
4	23	Becky Sheil	285-7779	Miss Nanken
4	23	Margaret Lynch	285-6490	Miss Nanken
4	24	Connie Magrino	285-7837	Mrs. Inwald
4	24	Barbara LaCroce	825-8579	Mrs. Inwald
4	24	Kathy Cardalena	825-5431	Mrs. Inwald
4	24	Jo Anne Santoro	285-5805	Mrs. Inwald
4	25	Gerry Sullivan	561-8694	Mr. Camilleri
4	25	Mary Werkmeister	872-8987	Mr. Camilleri
4	25	Mary Tragner	285-9502	Mr. Camilleri
4	25	Diane Bruendl	285-7312	Mr. Camilleri
5	27	Roseann Petruzillo	285-4795	Mrs. Totten
5	27	Jean Sivillo	825-6003	Mrs. Totten
5	27	Rosemary Smith	561-8667	Mrs. Totten
5	27	Gladys Sollitto	825-3865	Mrs. Totten
5	28	Joan Bauer	285-5049	Gerdyk

5	28	Connie Canicatti	872-0899	Mrs. Gerdyk
5	28	Effie Kenny	285-6281	Mrs. Gerdyk
5	28	Maureen Tkacik	285-5562	Mrs. Gerdyk
5	8	Fran Ciniglio	285-7996	Mrs. Stiefel
5	8	Winnie Eulner	285-7572	Mrs. Stiefel
5	8	Dorothy Fusco	285-5526	Mrs. Stiefel
5	8	Gloria Piccoro	285-9658	Mrs. Stiefel
6	21	Rose Accardo	285-8133	Mr. Cooper
6	21	Certrude Baerwald	872-3253	Mr. Cooper
6	21	Stella Rusinyak	285-8094	Mr. Cooper
6	21	Julie Fiorentino	285-9628	Mr. Cooper
6	22	Cheryl Holton	561-9055	Mrs. Perinchief
6	22	Marie Presti	285-9034	Mrs. Perinchief
6	22	Maureen Tkacik	285-5582	Mrs. Perinchief
6	22	Joan DeCandia	825-7242	Mrs. Perinchief

**FOREST ROAD SCHOOL
CLASS MOTHER LIST**

Class Mother Chairman

Linda Harris, 791-7827, and Betty Sabbatini, 791-8165

Grade	Room	Class Mother	Tel. Number	Teacher
*K	201	Debbie Schulman	825-0597	Mrs. Dankoff
K	201	Bette-Ann Shea	791-2699	Mrs. Dankoff
1	203	Sharon Bohmer	791-5367	Miss Cafiso
*1	203	Joan Frischling	791-7663	Miss Cafiso
1	203	Enid Parness	791-5960	Miss Cafiso
1	203	Linda Zahn	791-4516	Miss Cafiso
1	205	Linda Jones	791-5816	Miss Perrich
1	205	Arlene Panzer	791-3652	Miss Perrich
*2	205	Rochelle Rubin	872-9270	Miss Perrich
*3	207	Sheila Boritz	791-9686	Mrs. Cummings
3	207	Gale Dancyger	791-2035	Mrs. Cummings
3	207	Felicia Katz	791-9501	Mrs. Cummings
3	209	Laura Hans	791-1764	Miss Clarke
3	209	Sharon Levine	791-6872	Miss Clarke
3	210	Mary Eisenstein	791-8029	Mrs. Cabral
4	210	Helene Klein	791-1697	Mrs. Cabral
*4	210	Leslie Levy	791-8066	Mrs. Cabral
4	210	Donna Lubell	791-4568	Mrs. Cabral
4	211	Rita Kaplan	791-1695	Miss Post
4	211	Rhoda Levine	791-3148	Miss Post
4	211	Abby Tedesco	791-2157	Miss Post
4	211	Loise Wenzel	791-6354	Miss Post
5	215	Ellen Filler	791-6354	Miss Post
5	215	Evelyn Grabois	872-6377	Miss Schwartz
5	215	Sandra Train	791-1604	Miss Schwartz
5	218	Linda Harris	791-7827	Mrs. Kessler
5	218	Carol Mutterperl	791-1060	Mrs. Kessler
*5	218	Roz Scheidt	791-9468	Mrs. Kessler
6	217	Pat Block	791-4920	Mrs. Melnick
6	217	Audrey Chason	791-8248	Mrs. Melnick
6	217	Shelley Koval	791-1232	Mrs. Melnick
6	217	Joyce Sprung	791-9122	Mrs. Melnick
6	217	Phylliss Woin	791-8120	Mrs. Melnick
6	220	Gloria Feig	791-6315	Mr. Lesser
6	220	Karen Fox	825-0105	Mr. Lesser
6	220	Laura Hans	791-1764	Mr. Lesser
6	220	Paulette Kirschenbaum	791-7045	Mr. Lesser
6	220	Leora Paletz	791-5274	Mr. Lesser
*6	220	Sima Pomerantz	791-4019	Mr. Lesser
6	220	Betty Sabbatini	791-8165	Mr. Lesser
6	220	Barbara Tankel	791-4276	Mr. Lesser

*Grade Coordinator

AUGUST 1979

NDAY	MONDAY	TUESDAY	WEDNESDAY	THURSDAY	FRIDAY	SATURDAY
ie best way to forget your own problems is to help someone else live theirs. * * * * *			1	2	3	4
ie trouble with people who talk too fast is that they often say mething they haven't thought of yet. * * * * *						
mper is what gets most of us into trouble. Pride is what keeps us ere. * * * * *						
5	6	7	8	9	10	11
12	13	14	15	16	17	18
		C.H.S. Bd. of Ed. Mtg., 8:00 p.m.				
19	20	21	22	23	24	25
26	27	28	29	30	31	
		Dist. No. 30 Bd. of Ed. Mtg.				

**VALLEY STREAM SCHOOL DISTRICT No. 30 AND
VALLEY STREAM HIGH SCHOOL
VALLEY STREAM, NEW YORK**

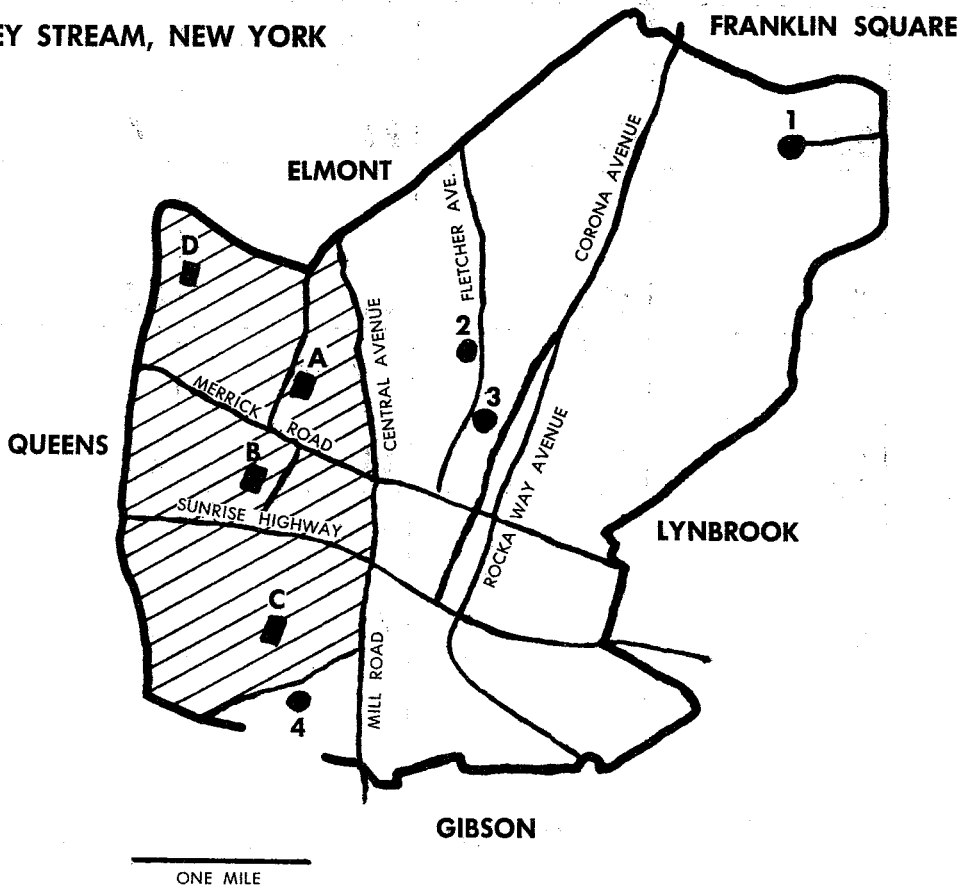

DISTRICT No. 30 SCHOOLS

Shaw Avenue	A
Clear Stream Avenue	B
Forest Road	C
Washington Avenue	D

Shaded Area — District 30

HIGH SCHOOLS

North High	1
Memorial Junior	2
Central High	3
South High	4

SCHOOL TELEPHONE DIRECTORY

MAIN OFFICE: SHAW AVENUE SCHOOL
 Superintendent VA 5-9131
 Business Office VA 5-9131
 Administration Manager VA 5-9131

Shaw Avenue School
 Principal's Office VA 5-9131
 Nurse's Office VA 5-9131

Washington Avenue School
 Office VA 5-9131

Clear Stream Avenue School
 Principal's Office VA 5-3044
 Business Office VA 5-3044

Special Services
 Psychologist VA 5-9131
 Speech Consultant VA 5-9131
 Reading Consultant PY 1-7676
 Audio-Visual Consultant LO 1-1165

Forest Road School
 Principal's Office PY 1-7676
 Business Office PY1-7676

INDEX

Board of Education and School Calendar see October
Administration and Special Services see November
Clear Stream PTA see December
Shaw Avenue PTA see January
Forest Road PTA see February
Student's Request of Teacher see March
History of District Schools see April
School Policies see May and June
Shaw Class Mothers see July
Clear Stream and Forest Class Mothers see August
Map of the District see facing page

VALLEY STREAM HIGH SCHOOL
 Telephone Number: 824-2073
 Use this number for all high school buildings, offices and personnel

NOTES

VALLEY STREAM UNION FREE SCHOOL
DISTRICT THIRTY

30

SCHOOL ACTIVITIES

Calendar

F O R 1 9 7 9 - 1 9 8 0

PUBLISHED BY THE BOARD OF EDUCATION AND PARENT-TEACHER ASSOCIATIONS

TELEPHONE DIRECTORY

INDEX

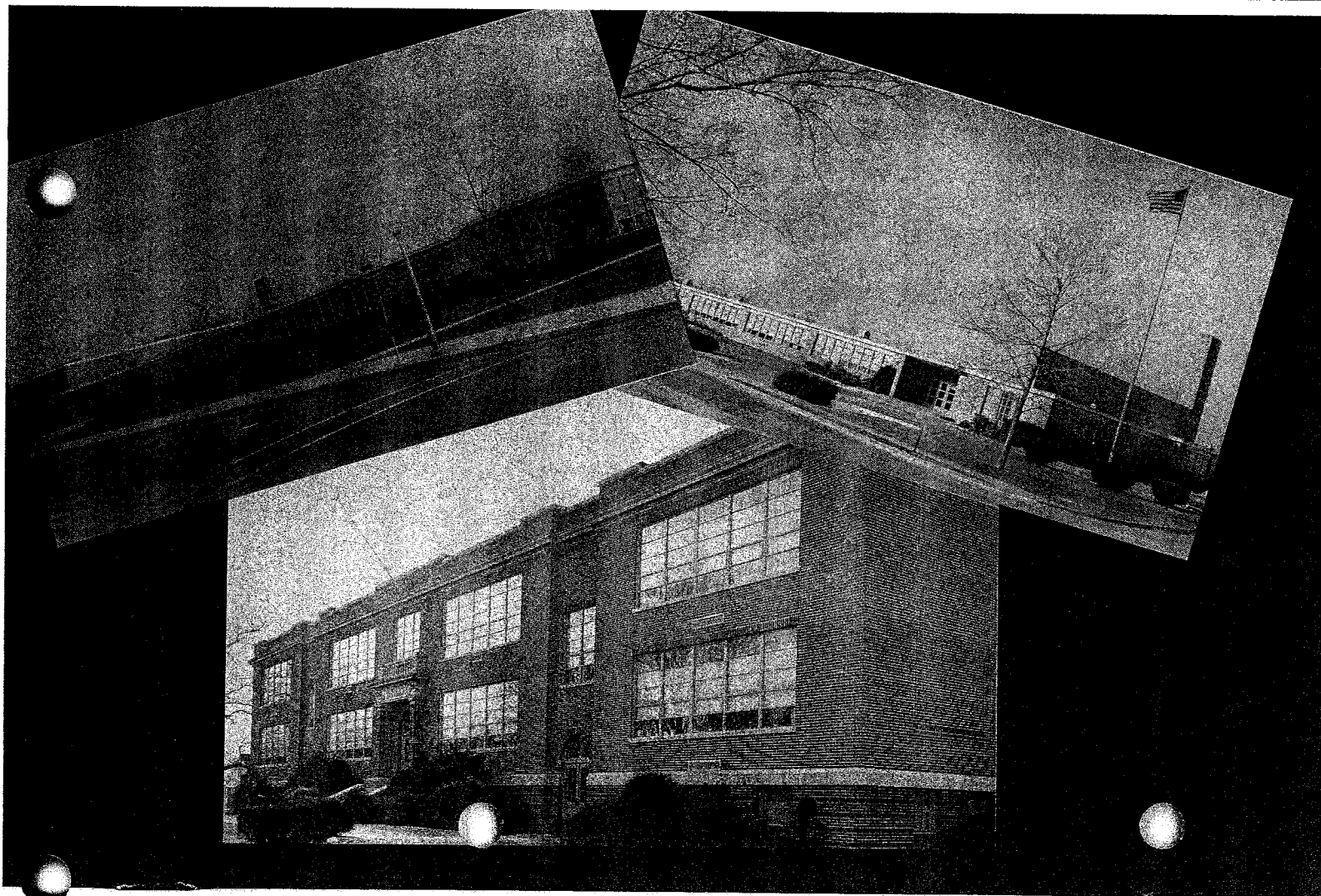

SEPTEMBER 1979

SUNDAY	MONDAY	TUESDAY	WEDNESDAY	THURSDAY	FRIDAY	SATURDAY
<p>er or later, people, if they are wise, discover that business life is a ure of good days and bad, victory and defeat, give and take. They that . . . —it doesn't pay to be a sensitive soul—that they should me things go over their heads.</p>			<p>—A person who loses his temper usually loses. —Everyone has burned toast for breakfast, now and then, and that they shouldn't take the other person's grouch too seriously. —Buck-passing usually turns out to be a boomerang. —It doesn't do any harm to smile and say "good morning," even if it is raining.</p>			1
2	3	4	5	6	7	8
		FACULTY MEETING	SCHOOL OPENS	PTA Ex. Bd. Mtg., Clear Stream, 9:30 p.m.		
9	10	11	12	13	14	15
	Grs. 4, 5, 6 Jr. Bowling, Shaw, 7:30 p.m.	PTA Gym Suit Sale, Forest, 2:45 p.m.	PTA Gym Suit Sale, Forest, 2:45 p.m.; Children's Bowling Mtg., Parents, Forest, 7:30 p.m.; Class Mother's Mtg., Forest, 8:00 p.m.	Parents' Night, (Grs. 4-6), Shaw, 8:15 p.m. PTA Bowling Begins, Shaw		
16	17	18	19	20	21	22
	Jr. Bowling Begins, Shaw	PTA Bowling Begins, Clear Stream; Meet the Teacher Night, Forest, 7:30 p.m.	PTA Gen. Mtg., & Parents' Night (Grs. K-3), Clear Stream, 7:30 p.m.; PTA Mtg., Shaw 8:00 p.m.	PTA Gen. Mtg., & Parents' Night, (Grs. 4-6), Clear Stream, 7:30 p.m.; Parents' Night, (Grs. K-3), Shaw, 8:15 p.m.		
23	24	25	26	27	28	29
30		Dist. No. 30 Bd. of Ed. Mtg., 8:15 p.m.			5th & 6th Gr. Bowling Begins, Forest	PTA Flea Market Shaw



Standing (left to right): Eleanor Berger, Treasurer; Albert D'Agostino, Attorney; William J. Van Ness, Superintendent of Schools; Eleanor Zeller, District Clerk; Seated: Robert Ezrol, Elinor McAuliffe,* Stephen Bazil,* Joseph Barry,* James Balducci.
**Also serves on the High School Board.*

SCHOOL CALENDAR, 1979-80

Meeting	Tues., Sept. 4	Christmas Recess	Dec. 22 thru Jan. 1
Opens for Students	Wed., Sept. 5	Reopen on Tues., Jan. 2	
Yom Kippur	Mon., Oct. 1	Winter Recess	Feb. 16 thru Feb. 24
Bus Day	Mon., Oct. 8	Reopen on Mon., Feb. 25	
Giving Recess	Nov. 22 thru Nov. 25	Easter Recess	Mar. 22 thru Apr. 8
	Close regular times Nov. 21—	Reopen on Wed., Apr. 9	
	Reopen on Mon., Nov. 26	Memorial Day	Fri., May 30
		Last Day of School	Fri., June 20

*Note: June 19 thru June 27 may have to be used in make-up of emergency closings.

OCTOBER 1979

SUNDAY	MONDAY	TUESDAY	WEDNESDAY	THURSDAY	FRIDAY	SATURDAY
	1 YOM KIPPUR SCHOOL CLOSED	2	3 PTA Ex. Bd. Mtg., Forest, 8:00 p.m.	4 PTA Ex. Bd. Mtg., Clear Stream, 9:30 a.m.	5	6
7	8 COLUMBUS DAY SCHOOL CLOSED	9 C.H.S. Bd. of Ed. Mtg., 8:00 p.m.	10	11	12 PTA Cupcake Sale, Clear Stream, 2:45 p.m.	13
14	15 PTA Council Mtg., Howell, 8:00 p.m.	16	17 PTA Mtg., Shaw, 8:00 p.m.	18 PTA Gen. Mtg., Clear Stream, 8:00 p.m.	19	20
21	22	23 Dist. No. 30 Bd. of Ed. Mtg., 8:15 p.m.	24	25 Nassau Dist. PTA Fall Conference, 7:15 p.m.	26 Talent Show, Clear stream, 8:00 p.m.	27
28	29	30	31 HALLOWE'EN 5th & 6th Grade Hallowe'en Party, Clear Stream, 7:30 p.m.	A suburbanite put on a last-minute spurt of speed to catch his train—but missed it. A bystander remarked, "If you had just run a little faster you would have made it." "No," the suburbanite replied, "it wasn't a case of running faster, but of starting sooner."		

Dr. William T. Callahan, *District Superintendent*
 William J. Van Ness
Superintendent of Schools
 Peter Weber, *School Business Manager*

Frank DeMarco, Director of Educational Communications
 Rosalyn Kessler, Psychologist
 Estelle Friedman, Psychologist
 Sharon Schulman, Speech Teacher
 Jill Green, Speech Teacher
 Henry Kohlmann, Instrumental Music Teacher
 Barbara Wieder, Instrumental Music Teacher
 Andrea Eden, Learning Disabilities Teacher

SCHOOL PRINCIPALS

CLEAR STREAM AVENUE SCHOOL
 Richard M. Burbell

FOREST ROAD SCHOOL
 Maurice E. St. Mary

SHAW AVENUE SCHOOL
 Lawrence Cid

OTHER SPECIALISTS AND SPECIAL TEACHERS

Clear Stream Avenue School

Verna Hearn, Special Counselor
 Carol Kornobis, Reading Specialist
 Grace Giacobone, Art
 Philip Hessemer, Physical Education
 Linda Pratt, Music
 Ruth Newman, Library Media Specialist
 Eileen Limoncelli, Nurse

Forest Road School

Helen Fink, Special Counselor
 Ada Keaney, Reading Consultant
 Eileen Goldsmith, Art
 Alfred Stevens, Physical Education
 Frances Gibson, Music
 Anita Strelisker, Library Media Specialist
 Hilda Rosenfeld, Nurse-Teacher

Shaw Avenue School

Noel Giambalvo, Special Counselor
 Rosemary Williams, Reading Teacher
 Linda Muckle, Art
 Pamela Trimes, Art
 Thomas Rouse, Physical Education
 Joan Stein, Physical Education
 Kathryn Egan, Music
 Barbara Briker, Music
 Sylvia Berkowitz, Library Media Specialist
 Eileen Cocoran, Nurse

SCHOOL SECRETARIES

Connie Deering, Clear Stream Avenue
 Anna Docar, Shaw Avenue
 Stella Schlaeger, Forest Road

SECRETARIAL STAFF

Maret Bradley	Mable Hom	Mary Ribando
Anna Zweier	Lillian Ging	Jean Annona
Barbara Stern	Maude Henn	Lorraine Tucci

Evelyn Pearn, *Cafeteria Manager*

NOVEMBER 1979

SUNDAY	MONDAY	TUESDAY	WEDNESDAY	THURSDAY	FRIDAY	SATURDAY
				1 PTA Ex. Bd. Mtg., Clear Stream, 9:30 a.m.	2	3
4	5	6 ELECTION DAY SCHOOL OPEN	7 Dist 30 PTA's Special Mtg., Shaw, "Math in Your Child's Future," Dr. Geo. Lenchner	8	9	10 PTA Art Auction, Shaw, 7:30 p.m.
11	12 VETERAN'S DAY SCHOOL CLOSED	13 C.H.S. Bd. of Ed. Mtg., 8:00 p.m.; PTA Gen. Mtg., Library Show, Forest, 8:00 p.m.	14	15 PTA Gen. Mtg., Clear Stream, 8:00 p.m.	16	17
18	19	20	21 FULL DAY OF SCHOOL	22 THANKSGIVING DAY SCHOOL CLOSED	23 SCHOOL CLOSED	24
25	26 SCHOOL REOPENS	27 Dist. No. 30 Bd. of Ed. Mtg., 8:15 p.m.	28	29	30	

CLEAR STREAM AVENUE PARENT TEACHER ASSOCIATION

ELECTED OFFICERS 1979-1980

<i>Co-Presidents</i>	Carol Gergel	285-8519
	Lois Barry	285-8654
<i>1st Vice President</i>	Rosemary Smith	561-8667
<i>2nd Vice President</i>	Pat Torres	285-5676
<i>Treasurer</i>	Madeline Weiss	825-1719
<i>Membership</i>	Faith Breiner	285-9101
<i>Corresponding Secretary</i>	Arlene Ercole	285-8127
<i>Recording Secretary</i>	Mary Ann McGullam	285-4614
<i>Delegates to Council</i>	Barbara Parisi	825-3214
	Florence Volpe	872-3517
	Lillian Guberman	Faculty
<i>Past Presidents</i>	Eileen Calandrino	825-6470
	Lenore Vita	285-5394

COMMITTEE CHAIRMEN

<i>Arts & Flyers</i>	Amelia Pascoello	872-3119
	Joan Deachman	872-9174
<i>Audio-Visual</i>	Frank DeMarco	Faculty
<i>Budget</i>	Lenore Vita	285-5394
<i>Cultural Arts</i>	Rosemary Smith	561-8667
	Eileen Calandrino	825-6470
<i>Distribution</i>	Marilyn Kelly	285-4955
	Mary Kajdacs	285-8457
<i>Gifted & Talented</i>	Mary Ann McGullam	285-4614
	Diane Bruendl	285-7312
<i>Health</i>	Fran Gentile	872-3206
<i>Historian</i>	Theresa Benedetto	285-5410
<i>Hospitality</i>	Florence Volpe	872-3517
	Kathy Wright	212-528-4255
<i>Legislation</i>	Marge Rollo	825-0929
	Jean Sivillo	825-6003
<i>Parent Education</i>	Verna Hearn	Faculty
<i>Pre-School</i>	Pat Torres	285-5676
<i>Publicity</i>	Diane Bruendl	285-7312
<i>School & Community</i>	Barbara Parisi	825-3214
<i>Special Education</i>	Jeanne Flight	872-9016
<i>Streamer</i>	Eileen Calandrino	825-6470
<i>Sunshine</i>	Rose Accardo	285-8113
<i>Ways & Means</i>	Lenore Vita	285-5394
	Rosemary Smith	561-8667
	Patricia Duffy	212-276-1240
	Kathy Wright	212-528-4255
<i>Bowling President</i>	Roseann Petruzillo	285-4795
<i>Secretary</i>	Fran Passarelli	872-9429
<i>Treasurer</i>	Dottie Walz	825-8011

<i>Junior Bowling</i>	Al Angerthal	872-8252
<i>Grade Rep. Chairman</i>	Maureen Tkacsik	285-5582
<i>Kindergarten Gr. Rep.</i>	Marilyn LeDu	872-9644
<i>1st Grade Rep.</i>	Mary Lynch	285-6490
<i>2nd Grade Rep.</i>	Barbara Clarke	872-8415
<i>3rd Grade Rep.</i>	Marion Acquavella	825-2272
<i>4th Grade Rep.</i>	Faith Breiner	285-9101
<i>5th Grade Rep.</i>	Gerry Sullivan	561-8694
<i>6th Grade Rep.</i>	Ann Prisco	285-5744

P.T.A. PROGRAM

Sept.	6	Executive Board Meeting, 9:30 a.m.
	18	PTA Bowling Begins
	19	PTA General Meeting & Parents' Night, 7:30 p.m. (K-3)
	20	PTA General Meeting & Parents' Night, 7:30 p.m. (4-6)
Oct.	4	Executive Board Meeting, 9:30 a.m.
	12	Cupcake Sale, 2:45 p.m.
	18	PTA General Meeting, 8:00 p.m.
	25	Nassau District PTA Fall Conference, 7:15 p.m.
	31	5th & 6th Grade Halloween Party, 7:30 p.m.
Nov.	1	Executive Board Meeting, 9:30 a.m.
	7	"Mathematics in Your Child's Life," Dr. G. Lenchner, Shaw Ave., 8:00 p.m.
	15	PTA General Meeting, 8:00 p.m.
Dec.	6	Executive Board Meeting, 9:30 a.m.
		Pre-School Meeting, 1:30 p.m. (Parents of 4 yr. olds)
	13	PTA Holiday Boutique, 2:45 p.m.
	14	PTA Holiday Boutique, 2:45 p.m.
	21	PTA Holiday Program, 1:30 p.m.
Jan.	3	Executive Board & General Meeting, 9:30 a.m.
Feb.	7	Executive Board Meeting, 9:30 a.m.
	15	PTA Cupcake Sale, 2:45 p.m.
Mar.	6	Executive Board Meeting, 9:30 a.m.
		Pre-School Meeting, 1:30 p.m. (Parents of 4 yr. olds)
	7	Father, Son & Daughter Night, 7:30 p.m.
	13	Pre-School Meeting, 1:30 p.m. (Parents of 3 yr. olds)
	20	PTA General Meeting, 8:00 p.m.
April	10	Executive Board Meeting, 9:30 a.m.
	24	Teachers' Recognition Day Luncheon, 11:15 a.m.
	26	PTA Vision Screening, 9 a.m.
May	1	Executive Board Meeting, 9:30 a.m.
	8	Mothers' Day Boutique, 2:45 p.m.
	9	Mothers' Day Boutique, 2:45 p.m.
	13	Nassau District PTA Spring Conference, 7:15 p.m.
	15	Installation, 8:00 p.m.
June	5	Joint Executive Board Meeting, 9:30 a.m.

DECEMBER 1979

SUNDAY	MONDAY	TUESDAY	WEDNESDAY	THURSDAY	FRIDAY	SATURDAY
						1
						2
	3					4
	PTA Council Mtg., Brooklyn Ave., 8:00 p.m.					5
			6	7	8	9
			PTA Ex. Bd. Mtg., Forest, 8:00 p.m.; PTA Mtg., Shaw, 8:00 p.m.	PTA Ex. Bd. Mtg., Clear Stream, 9:30 a.m.; Pre-school Mtg., Clear Stream, 1:30 p.m.		10
	11					12
	PTA Holiday Boutique, Forest, 2:45 p.m.; Pre-School Meeting, Shaw, 3:00 p.m.	13				14
		C.H.S. Bd. of Ed. Mtg., 8:00 p.m.				PTA Holiday Boutique, Clear Stream, 2:45 p.m.; Holiday Music Program, Clear Stream, 8:00 p.m.
		PTA Holiday Boutique, Forest, 2:45 p.m.	15			16
			PTA Holiday Boutique, Shaw	PTA Holiday Boutique, Clear Stream, 2:45 p.m.		HANUKAH
						17
						18
						19
						20
						21
						22
						23
						24
	CHRISTMAS RECESS SCHOOL CLOSED					25
						26
						27
						28
						29
						30
	CHRISTMAS RECESS					31
		CHRISTMAS DAY				
			CHRISTMAS RECESS			
				CHRISTMAS RECESS		
					CHRISTMAS RECESS	

ELECTED OFFICERS 1979-1980

idents	Marianne Bond	285-6405
	Diane Keenan	285-6068
e President	Nancy Daly	285-6058
ce President	Mary Ann Kass	825-8153
er	Sue Zouloufis	825-7641
ial Secretary	Carol Blankshine	825-3119
po	Vera Manzo	872-8717
ling	Pat Soltero	285-6373
es to Council	Miriam Sweet	Faculty
	Marie Verriello	285-5171
	Elaine Kelly	825-0113

COMMITTEE CHAIRMEN

Visual	Mr. J. Giacalone	Faculty
ing	Mary Zeiner	285-9898
wling	Kathy Giannico	285-4932
t	Vera Manzo	872-8717
	Lillian Ging	285-6072
al Arts	Anna Mormando	561-9047
	Carol Traisi	561-6348
ution	Pina Tarsia	561-6507
	Carol Pesche	285-6223
Rep. Coordinator	Undine Kaufman	285-8710
ian	Marie Veriello	285-5171
ality	Noleen Douglas	825-0561
ition	Elaine Kelly	825-0113
ership	Pat Soltero	285-6373
ograph	Gail Drucker	872-0760
etter	Marie Prete	285-5520
' Education	Ann Bochichio	285-7865
	Cathy Pellegrino	285-5764
chool	Mary Tornatore	872-0651
ity	Gail Drucker	872-0760
	Gloria Eversman	872-6975
l Board Rep. &	Diane Keenan	285-6068
l Community Relations		

Vision Screening
Ways & Means

Vera Manzo
Nancy Daly

872-8717
285-6058

P.T.A PROGRAM

Sept.	10	4th, 5th, and 6th Grade Jr. Bowling Meeting, Shaw, 7:30 p.m.
	13	Parents' Night, Shaw (Grades 4-6), 8:15 p.m.
	13	PTA Bowling Starts
	17	Jr. Bowling Begins
	19	PTA Meeting, Shaw, 8:00 p.m.
	20	Parents' Night, Shaw, (Grades K-3), 8:15 p.m.
	29	PTA Flea Market, Shaw
Oct.	17	PTA Meeting, Shaw, 8:00 p.m.
Nov.	7	Dist. 30 PTA's Special Meeting, Shaw, 8:00 p.m., Dr. Lenchner
	10	PTA Art Auction, Shaw, 7:30 p.m.
Dec.	5	PTA Meeting, Shaw, 8:00 p.m.
	10	Pre-School Meeting, Shaw, 3:00 p.m.
	12	PTA Holiday Boutique, Shaw
Jan.	16	PTA Cup Cake Sale, Shaw
	23	PTA Meeting, Shaw, 8:00 p.m.
Feb.	13	PTA Meeting, Shaw, 8:00 p.m.
Mar.	3	Pre-School Meeting, Shaw, 3:00 p.m.
	12	PTA Meeting, Shaw, 8:00 p.m.
	27	Shaw Avenue PTA Fashion Show, 8:00 p.m.
Apr.	23	PTA Volunteers Meeting, Shaw, 8:00 p.m.
	26	PTA Vision Screening, Shaw
May	7	Mothers' Day Boutique, Shaw
	12	Pre-School Meeting, Shaw, 3:00 p.m.
	21	PTA Meeting, Shaw, 8:00 p.m.
	22	PTA Installation Meeting & Teacher Recognition Day, Shaw
June	4	Fathers' Day Boutique, Shaw
	11	PTA Joint Executive Board Meeting, Shaw, 8:00 p.m.

JANUARY 1980

SUNDAY	MONDAY	TUESDAY	WEDNESDAY	THURSDAY	FRIDAY	SATURDAY
on going and the chances are you will le on something, perhaps when you are expecting it. I have never heard of e stumbling on something sitting down. ---Charles F. Kettering		1 NEW YEAR'S DAY SCHOOL CLOSED	2 SCHOOL REOPENS	3 PTA Ex. Bd. Mtg., Clear Stream, 9:30 a.m.	4	5
6	7	8 C.H.S. Bd. of Ed. Mtg., 8:00 p.m.	9 PTA Ex. Bd. Mtg., Forest, 8:00 p.m.	10	11	12
13	14	15	16 PTA Cupcake Sale, Shaw	17	18	19
20	21	22 Dist. No. 30 Bd. of Ed. Mtg., 8:15 p.m.	23 PTA Mtg., Shaw, 8:00 p.m.	24	25	26
27	28	29 PTA Gen. Mtg., Volley Ball Game, Forest, 8:00 p.m.	30	31	If you tell a man there are 300 billion stars in the universe, he'll believe you. If you tell him a bench has just been painted, he has to touch it to be sure.	

ELECTED OFFICERS 1979-1980

<i>Co-Presidents</i>	Linda Harris	791-7827
	Gloria Feig	791-6315
<i>1st Vice President</i>	Sharon Bohmer	791-5367
<i>2nd Vice President</i>	Joan Frischling	791-7663
<i>Treasurer</i>	Louise Wenzel	791-6354
<i>Financial Secretary</i>	Roz Scheidt	791-9468
<i>Corresponding Secretary</i>	Enid Parness	791-5960
<i>Recording Secretary</i>	Karen Bing	825-0105
<i>Delegates to Council</i>	Helene Klein	791-1697
	Ronnie Ragona	791-5190
<i>Past President</i>	Lydia Rosen	791-5488

COMMITTEE CHAIRMEN

<i>Amblyopia</i>	Jeryl DeNoie	791-4814
	Karen Bing	825-0105
<i>Bowling</i>	Elaine Sandler	791-5765
	Betty Fine	791-1806
	Alice Fischer	791-3824
<i>Budget</i>	Joan Frischling	791-7663
<i>Class Mothers</i>	Rhoda Levine	791-3148
	Roz Scheidt	791-9468
<i>Cultural Arts</i>	Anita Strelisker	PY 1-7167
<i>Ecology</i>	Helen Fink	
<i>Family Living</i>	Carol Mutterperl	791-1060
	Trena Danels	791-1506
<i>Flyers</i>	Sima Pomerantz	791-4019
<i>Goodwill</i>	Betty Ann Shea	791-2699
<i>Hospitality</i>	Gen Ferro	825-1445
<i>Health and Safety</i>	Jeryl DeNoie	791-4814
<i>Historian</i>	Marilyn Clarke	
<i>Legislation</i>	Marsha Langbart	791-8442
<i>Membership</i>	Roz Scheidt	791-9468
<i>Mimeograph</i>		
<i>Newsletter</i>	Karen Bing	825-0105
<i>Circulation</i>	Felicia Katz	791-9501
<i>Parliamentarian</i>	Judy Orloff	791-3820
<i>Pre-School</i>	Edna Crescas	791-5972
<i>Program Chairperson</i>	Joan Frischling	791-7663
<i>School Board Rep. Elem.</i>	Dorothy Alperson	791-2284
<i>Teachers Rep.</i>		

Typist
Ways & Means
Boutique Holiday

Donna Lobell	791-4568
Sharon Bohmer	791-5367
Judy Orloff	791-3820
Judy Azzolina	791-4785
Sue Baxter	791-6084
Debbie Schulman	791-6857
Abby Tedesco	791-2157
Pat Block	791-4920
Donna Lobell	791-4568
Sharon Bohmer	791-5367

Plant Sale
Gym Suit Sale
Board Listings
Teacher Recognition Day
Book Fair

P.T.A. PROGRAM

Sept.	11	Gym Suit Sale, 2:45 p.m.
	12	Gym Suit Sale, 2:45 p.m.
		Children's Bowling Meeting for Parents, 7:30 p.m.
		Class Mothers Meeting, 8:00 p.m.
	18	Meet the Teacher, 7:30 p.m.
		(Scoliosis Film)
	28	5th and 6th Grade Bowling, 3:30 p.m.
Oct.	3	PTA Executive Board Meeting, 8:00 p.m.
Nov.	7	PTA Executive Board Meeting, 8:00 p.m.
	13	General Meeting—Library Show, 8:00 p.m.
Dec.	5	PTA Executive Board Meeting, 8:00 p.m.
	10	Holiday Boutique, 2:45 p.m.
	11	Holiday Boutique, 2:45 p.m.
Jan.	9	PTA Executive Board Meeting, 8:00 p.m.
	29	PTA General Meeting—Volleyball Game, 8:00 p.m.
Feb.	6	PTA Executive Board Meeting, 8:00 p.m.
	7	Founders Day—Forest Road
March	5	PTA Executive Board Meeting, 8:00 p.m.
	18	PTA General Meeting—Science Fair, 8:00 p.m.
April	9	PTA Executive Board Meeting, 8:00 p.m.
	29	Bicycle Safety Program, 1:00 p.m.
May	13	Music Show—PTA Installation, 7:45 p.m.
	24	PTA Vision Screening
June	3	Teachers Recognition Day
	4	PTA Joint Executive Board Meeting, 8:00 p.m.
	12	Fathers Day Boutique, 2:45 p.m.
	13	Fathers Day Boutique, 2:45 p.m.

FEBRUARY 1980

SUNDAY	MONDAY	TUESDAY	WEDNESDAY	THURSDAY	FRIDAY	SATURDAY	
RIGHTS OF THE CHILD						1	2
3	4 PTA Council Mtg., Clear Stream, 8:00 p.m.	5	6 PTA Ex. Bd. Mtg., Forest, 8:00 p.m.	7 PTA Ex. Bd. Mtg., Clear Stream, 9:30 a.m. PTA Founders' Day Mtg. Forest Road for all 3 Schools	8	9	
10	11	12 LINCOLN'S BIRTHDAY SCHOOL OPEN C.H.S. Bd. of Ed. Mtg., 8:00 p.m.	13 PTA Mtg., Shaw, 8:00 p.m.	14	15 PTA Cupcake Sale, Clear Stream, 2:45 p.m.	16	
17	18 WINTER RECESS SCHOOL CLOSED	19 WINTER RECESS SCHOOL CLOSED	20 WINTER RECESS SCHOOL CLOSED ASH WEDNESDAY	21 WINTER RECESS SCHOOL CLOSED	22 WINTER RECESS SCHOOL CLOSED WASHINGTON'S BIRTHDAY	23	
24	25	26	27	28	29	30	
31 SCHOOL REOPENS		Dist. No. 30 Bd. of Ed. Mtg., 8:15 p.m.					

RAISING MISFITS.

(Former) Commissioner George B. McClellan of the Royal Canadian Mounted Police put it this way when addressing the Empire Club in Toronto: "It is not juvenile delinquency I want to speak about—it is parental delinquency—because, in my humble opinion, the group which is creating the problems I have referred to is, for the most part, a product of irresponsible homes and irresponsible parents. I think the trouble begins in the home, and ultimately it will have to be corrected in the home."

"Very often," said the Commissioner, "I have heard the cry of an anguished or bewildered parent, 'How did my child get to be this way?' Well, the seed for good or evil is in all of us, and the fruit of it depends on its cultivation."

Obviously, these experienced men believe that it is better to prevent the problem of delinquency from arising rather than to invoke the law to cure its effects.

Instead of giving the usual catalogue of virtues to be cultivated, Commissioner McClellan sharpened his lesson by listing 10 effective methods to use so that a child will become an antisocial misfit:

1. Do not have any rules for child behavior or obedience in the home. This will ensure that the child has no clear concept of right or wrong.
2. If you have any rules, enforce them intermittently. Ignore them when you are in good humor and knock the kid silly if he breaks the rules when you are tired and out of sorts. This will confuse him thoroughly. He won't know what is expected of him and will eventually resent all discipline.
3. Air your domestic disputes right out in front of the child, preferably with a little name-calling. This will ensure

that he has no respect for either of his parents.

4. Never give a child any chores or regular duties around the home. This will convince him that you and the world owe him a living, without effort on his part.

5. If he is disciplined at school, always go to the school and tear a strip off the teacher or the principal in front of the child. This will create an excellent contempt for authority at any level.

6. Later, when he has trouble with the police, which is most likely, bawl out the officer, or, better still, the Chief, being always sure to refer to the 'dumb cop.' This procedure will earn the child a diploma in contempt for authority.

7. When you are out driving with the family, exceed the local speed limit, but slow down when you see a police car. Be sure to speed up as soon as the police car is out of sight. This will show the child that the law is to be observed only if there is any danger of being caught.

8. If you are stopped by the police for speeding, and you are speeding, always deny flatly that you were exceeding the speed limit. Make a big fuss over it. Your child will then know that cheating and lying are acceptable procedures.

9. If you have managed to chisel a few dollars on your income tax, be sure and tell the family at the dinner table that night how smart you are. This should convince the youngsters that stealing is all right if you can get away with it.

10. Never check up on where your youngsters are in the evening. Never mind what time they get home. Never, never, try to learn anything about their friends. This one is almost sure fire.

MARCH 1980

SUNDAY	MONDAY	TUESDAY	WEDNESDAY	THURSDAY	FRIDAY	SATURDAY
					—Robert Frost	1
					—Sir Alan Herbert	
2 PURIM	3 Pre-school Mtg., Shaw, 3:00 p.m.	4	5 PTA Ex. Bd. Mtg., Forest, 8:00 p.m.	6 PTA Ex. Bd. Mtg., Clear Stream, 9:30 a.m.; Pre-school Mtg., Clear Stream, 1:30 p.m.	7 Father, Son, Daughter Night, Clear Stream, 7:30 p.m.	8
9	10	11 C.H.S. Bd. of Ed. Mtg., 8:00 p.m.	12 PTA Mtg., Shaw, 8:00 p.m.	13 Pre-school Mtg., Clear Stream, 1:30 p.m.	14	15
16	17 ST. PATRICK'S DAY	18 PTA Gen. Mtg., Science Fair, Forest, 8:00 p.m.	19	20 PTA Gen. Mtg., Clear Stream, 8:00 p.m.; PTA Fashion Show, Shaw	21	22
23	24	25	26	27	28	29
30 SUNDAY	31 EASTER RECESS SCHOOL CLOSED	Dist. No. 30 Bd. of Ed. Mtg., 8:15 p.m.		Dist. Music Concert, Shaw, 8:15 p.m.		

MONITORING YOUR CHILD'S EDUCATION

One of the best ways for parents to help their children in school is to "monitor" the youngsters' educational progress regularly, says Missouri Commissioner of Education Arthur L. Mallory.

"Families always monitor their financial situation. They monitor the health of family members and go to the doctor for help when necessary. Parents keep an eye on the condition of the house and the car and make minor repairs or adjustments in order to avoid major problems later. By the same token, parents should make an effort to keep tabs on their children's activities in school, their attitudes about school and their academic progress," Mallory said.

"... Monitoring," Mallory said, "doesn't mean always looking over the child's shoulder or pressuring him to make good grades. It should be a positive activity, a way for parents to show children that they are concerned and care about a youngster's happiness and success in school."

"Children almost always do better in school when they know that their parents believe school is important and are willing to take the time to be helpful and encouraging."

Commissioner Mallory offers the following tips for parents on how to monitor and evaluate their children's education in a beneficial way.

1. Talk about your mutual expectations. Encourage your children to set educational goals for themselves. Don't set your own expectations too high for your youngster to achieve, and don't insist that grades are the only measure of

success.

2. Try to find out your youngster's relative strengths and weaknesses in school. Encourage them to make the most of their abilities and to work on the weaknesses.

3. Develop a friendly, open relationship with your child's teachers. Ask to be kept informed about your youngster's activities. Go to parent-teacher conferences. Don't wait until report card time to find out how your youngster is doing in a class.

4. Try to help your children with lessons whenever possible, but don't do the work for them. Ask the teacher how you can help with specific lessons or related activities at home.

5. Take time to talk about school; be available for school-related activities.

6. If you ask "What did you do in school today?" don't accept "Nothing" for an answer. By encouraging youngsters to recall what they did during the day, you help them remember important points from their lessons.

7. Be alert to your youngster's attitudes about school. Don't let your student develop a "don't care" attitude. Such an attitude will be noticeable in the early grades and will be devastating in high school.

8. Help your youngster understand that school is often hard work and requires study and self-discipline. Hard work "on the books" usually is not fun, but achieving "victory," through making the best grades of which the student is capable, makes the hard work worthwhile.

APRIL 1980

SUNDAY	MONDAY	TUESDAY	WEDNESDAY	THURSDAY	FRIDAY	SATURDAY
Trust a few, do wrong to no one. * * * World, it is not what we take up, but give up, that makes us rich. * * * Endures with patience is a conqueror.		1 PASSOVER EASTER RECESS SCHOOL CLOSED	2 EASTER RECESS SCHOOL CLOSED	3 HOLY THURSDAY EASTER RECESS SCHOOL CLOSED	4 GOOD FRIDAY EASTER RECESS SCHOOL CLOSED	5
6	7 SEVENTH DAY OF PASSOVER SCHOOL CLOSED	8 EIGHTH DAY OF PASSOVER SCHOOL CLOSED C.H.S. Bd. of Ed. Mtg., 8:00 p.m.	9 SCHOOL REOPENS PTA Ex. Bd. Mtg., Forest, 8:00 p.m.	10 PTA Ex. Bd. Mtg., Clear Stream, 9:30 a.m.	11	12
13	14 PTA Council Mtg., Willow, 8:00 p.m.	15	16	17	18 Spring Melodies, Clear Stream, 8:00 p.m.	19
20	21	22	23 PTA Volunteers Mtg., Shaw, 8:15 p.m.	24 Reg. for Budget Vote, Each School, 7-9 a.m. & 4-9 p.m.; Teachers' Recognition Day, Clear Stream.	25 Reg. for Next Year's Kindergarten, Each School, 9-11 a.m.	26 PTA Vision Screening, Clear Stream, Shaw, 9:00 a.m.
27	28	29 Bicycle Safety Program, Forest, 1:00 p.m.; Dist. No. 30 Bd. of Ed. Mtg., 8:15 p.m.	30	Nothing is really work unless you would rather be doing something else. * * * A day of worry is more exhausting than a week of work. * * * Speak well of everyone if you speak of them at all.		

SCHOOL POLICIES

SCHOOL HOURS

hours for grades 1, 2, and 3 are from 9:00 a.m. to 3:00 p.m.
hours for grades 4, 5, and 6 are from 8:30 a.m. to 2:45 p.m.

LUNCH

ch is served beginning with the first day of school. Pupils may go
e lunch, bring lunch from home, or buy the school lunch in
ca for 60¢. Monthly menus are provided so that if foods
served which your child does not eat, you can make other provi-
s for him for those days. In case a child forgets his lunch money
is lunch, or loses either, we have a charge system to cover the
gency except the week before a recess and summer vacation.
cashier in the cafeteria keeps the record of such charges and con-
the parents should a charge not be paid in a reasonable time.

ICE CREAM

ream is sold daily to those pupils who wish it. It is *not* part of the
lunch and costs an additional 15c.

RECESS MILK

ss milk is available to all children beginning about the third week
e school year and is sold at a cost of 50c per week payable each
sday for the following week. You will be notified as to exact
Money brought in late (Friday) cannot be accepted. In case of a
's absence, no refund is made for periods of less than a full

ABSENCES

n your child has been absent, State law requires that he bring a
from you explaining the absences and the date(s) of absence(s).
note should be presented to the nurse *before* he goes to the
room. Please be specific. Just saying, "he was ill," is not
gh. Indicate whether it was "virus," "fever," "cold," etc. A
is required for an absence due to a religious holiday. A note is
red for any tardiness, giving the reason. If your child contracts
tagious disease, such as mumps, measles, etc., please phone the
l nurse so that she can alert the parents in your child's class that
children have been exposed. Be sure to keep the emergency card
date so that we will know whom to call should a child
ne ill and have to go home.

NOON HOUR RULES

When pupils misbehave in the cafeteria, auditorium, or on the
playground during the noon hour, after repeated reminders, the
teachers have the authority to exclude them from staying in school
for lunch for a few days, or longer, depending on the misbehavior. If
you receive such a note from us, we would appreciate your coopera-
tion. Whether or not a mother is home during the noon hour has no
bearing on this exclusion.

RELEASED TIME FOR RELIGIOUS INSTRUCTION

A Release Form signed by the parent is necessary should you want
your child excused from school for religious instruction. Such forms
can be obtained from your church. The time provided is the last hour
of school on Wednesday afternoons.

EXITS AND ENTRANCES

Your child's class is assigned a specific exit and entrance to use. You
will thus know where to meet him if you come to pick him up.
Parents picking up children are asked to meet them at the exit, *not*
the classroom.

ENTRANCE TIMES

Morning—All Schools	Noontime—Shaw & Forest
Grades 1, 2, & 3—8:50	Grades 1, 2, & 3—12:50
Grades 4, 5, & 6—8:20	Grades 4, 5, & 6—12:20
Noontime—Clear Stream:	Grades 5 & 6—12:05
Grades 3 & 4—12:35;	Grades 1 & 2— 1:05

*Because there is no supervision of the playground in the morning, we
suggest you arrange your child's departure from home to allow him
to arrive just in time to enter the building during the proper interval.*
In inclement weather he may come into the designated area five
minutes before the above times.

CLASS INTERRUPTIONS

No unnecessary interruptions of classes are allowed once the day's
sessions have begun. When your child forgets a book, homework,
sneakers, lunch money, etc., please bring these to the office. All
pupils are instructed to check with the office at lunch time for such
forgotten items. In the interest of the child's all-round education, we
urge you not to make a practice of bringing forgotten items to
school. The child should be developing his own sense of responsibili-
ty for these things.

MAY 1980

SUNDAY	MONDAY	TUESDAY	WEDNESDAY	THURSDAY	FRIDAY	SATURDAY				
				1 Art Exhibit, Forest, 7:30-9:00 p.m.; PTA Ex. Bd. Mtg., Clear Stream, 9:30 a.m.; PTA Book Fair, Forest, 7:30-9:00 p.m.	2	3				
				4	5 Art Exhibit, Clear Stream, 7:30-9:00 p.m.	6 Art Exhibit, Shaw, 7:30-9:00 p.m.; Mother's Day Boutique, Shaw	7 Voting on School Budget, Each School, 7:00 a.m.-10:00 p.m.	8 Mother's Day Boutique, Clear Stream, 2:45 p.m.	9 Mother's Day Boutique, Clear Stream, 2:45 p.m.	10
				11	12 Pre-school Mtg., Shaw, 3:00 p.m.	13 C.H.S. Bd. of Ed. Mtg., 8:00 p.m.; Nassau Dist. PTA Spring Confer- ence, 7:15 p.m.; PTA Installation, Music Show, Forest, 7:45 p.m.	14	15 PTA Installation, Clear Stream, 8:00 p.m.; PTA Plant Sale, Forest, 2:45 p.m.	16	17
18 MOTHER'S DAY	19	20	21 SHAVUOTH PTA Mtg., Shaw, 8:00 p.m.	22 PTA Installation Mtg., Teacher Recognition Day, Shaw	23	24 PTA Vision Screening, Forest				
25	26	27 Dist. No. 30 Bd. of Ed. Mtg., 8:15 p.m.	28	29	30 MEMORIAL DAY SCHOOL CLOSED	31				

GYM SUITS AND SNEAKERS

Gym suits are required of pupils below the 3rd grade, but sneakers are necessary for any pupils using the gym. Boys and girls from the 3rd through 6th grades are required to wear gym suits and sneakers on their assigned gym days. The gym teachers will explain this to the parents, but many times they do not bring the correct information.

Who **MUST PURCHASE A NEW SUIT** should buy the two-piece **ROYAL BLUE**, bloomer type, with elastic bottoms, or **ROYAL BLUE** shorts with elastic insert in the cuff, and a white t-shirt. Boys should wear **ROYAL BLUE** shorts, with elastic top, and sneakers (high top ones preferred), and white or **SCHOOL "T"** shoes.

Who **HAS ANOTHER COLOR, OR TYPE, HE DOES NOT HAVE TO BUY A NEW ONE.** The above apparel may be purchased at many local stores in Valley Stream. **NO ONE IS ALLOWED ON THE GYM FLOOR WITHOUT SNEAKERS.**

APPOINTMENTS WITH TEACHERS

Remember that pupils' classtime be used to the fullest advantage, we request that parents do not seek conferences with teachers during school hours. If you wish a conference, please make an appointment with the teacher after school. Teachers are available for such conferences every day except Wednesdays and Fridays.

BICYCLES

Bicycles are allowed at either Forest Road or Clear Stream Schools because no child lives far enough from the school to make them necessary. They are allowed at Shaw, but are restricted to only grades 4, 5, and 6 who live **NORTH OF FOSTER AVENUE**. Bicycles used to come to the Shaw Avenue School will be numbered. All must have a lock and chain for safety purposes.

GIFTS TO TEACHERS PROHIBITED

Policy of the school district which became effective January 1, 1980, is to prohibit the acceptance of gifts by faculty members on school premises, and to prohibit the solicitation of funds for personal purposes, by any person, or persons, on the premises.

IN-DAY PROGRAM

In inclement weather, there is an in-day program of motion pictures or quiet games provided for those pupils who eat in the cafeteria. Pupils who go home to lunch are not allowed to participate in this program because of space limitations, so we ask parents to return these pupils to school on such days just in time for the afternoon session—not before 12:50 p.m. for grades 1 to 3, and 12:20 p.m. for grades 4 to 6 at Shaw and Forest; and not before 12:05 p.m. for grades 5 and 6, 12:35 p.m. for grades 3 and 4, and 1:05 p.m. for grades 1 and 2 at Clear Stream.

HOMEWORK REQUIREMENTS

Homework is required of all pupils, but it will vary from day to day. First and second grade pupils may have fifteen to twenty minutes of homework per day, while third and fourth grade pupils are likely to have thirty to forty minutes. Fifth and sixth graders are expected to devote as much as an hour to homework, but again this may not be every day—it will depend on the pupil and his needs.

LOST AND FOUND

Unmarked articles lost by pupils are placed in the Lost-and-Found, which is in the Nurse's Office at Shaw & Forest, and the custodian's office at Clear Stream. Such articles, if not claimed at the end of the school year, are given to a charitable organization. However, any article bearing a child's name is returned directly to him. Please place your child's name on all his belongings.

STAYING AFTER SCHOOL

To eliminate any confusion or problems, the school may have your child every day for an additional half hour. During this half hour beyond the regular school day, the teacher may schedule your child for special help or keep him for any of several reasons. We ask that you keep this in mind and not schedule dental appointments, dancing lessons, etc., until after that interval. Teachers are also available to parents during the half hour after school, except on Wednesday and Friday, for conferences.

ASSEMBLIES

When your child's class puts on the assembly, we welcome your attendance, but we do ask you not to bring pre-school children. As much as we realize that it is a thrill for them to see big brother perform, they are often distracting to all concerned. Picture taking is not allowed without prior approval.

JUNE 1980

SUNDAY	MONDAY	TUESDAY	WEDNESDAY	THURSDAY	FRIDAY	SATURDAY
1	2	3	4	5	6	7
	String Festival, Shaw, 7:30 p.m.	String Festival, Forest, 7:30 p.m.; Teacher Recognition Day, Forest	String Festival, Clear Stream, 7:30 p.m.; Father's Day Boutique, Shaw	PTA Joint Ex. Bd. Mtg., Clear Stream, 9:30 a.m.		
8	9	10	11	12	13	14
	PTA Council Mtg., South H.S., 8:00 p.m.	C.H.S. Bd. of Ed. Mtg., 8:00 p.m.	PTA Joint Ex. Bd. Mtg., Shaw, 8:00 p.m.	PTA Father's Day Boutique, Forest, 2:45 p.m.	PTA Father's Day Boutique, Forest, 2:45 p.m.	
15	16	17	18	19	20	21
FATHER'S DAY			Closing Exercises For Sixth Grades		SCHOOL ENDS	
22	23	24	25	26	27	28
		Dist. No. 30 Bd. of Ed. Mtg., 8:15 p.m.				
29	30	31	A good boss is someone who takes a little more than his share of the blame and a little less than his share of the credit. * * * You never get a second chance to make a good first impression. * * * The goal of criticism is to leave the person with the feeling that he or she has been helped.			

*May be used for make-up of emergency closings

SHAW AVENUE SCHOOL

CLASS MOTHER LIST

Class Mother Chairman..... Undine Kaufman, 285-8710

Room	Class Mother	Tel. Number	Teacher
Kindergarten Representative	Jane Martin, 285-9598		
1 AM	Mrs. O'Brien	285-6016	Mrs. Neary
1 PM	Mrs. Tornatore	872-0651	Mrs. Neary
2 PM	Mrs. Martin	285-9598	Mrs. Melone
1st Grade Representative	Noeleen Douglas, 825-0561		
3	Mrs. DiNatale	872-0116	Mrs. Levine
5	Mrs. Paolillo	285-5541	Mrs. Lazar
6	Mrs. Cusumano	872-0470	Mrs. Hartman
2nd Grade Representative	Suzan Zouloufis, 825-7641		
6	Mrs. Eversman	872-6948	Mrs. Barra
8	Mrs. Kepenis	285-5312	Mrs. Graffigno
0	Mrs. Zouloufis	825-7641	Mrs. Geffner
3rd Grade Representative	Theresa Giordano, 872-0486		
4	Mrs. Chiano	285-7721	Mrs. Sweet
7	Mrs. Prete	285-7354	Mrs. Strumph
2	Mrs. Romano	872-3113	Mrs. Stuto

Gr. Room	Class Mother	Tel. Number	Teacher
4th Grade Representative	Anne Bochichio, 285-7865		
4 108	Mrs. Douglas	825-0561	Miss Starler
4 109	Mrs. Ruggiero	872-8980	Mrs. Benedetto
4 110	Mrs. Voloshin	285-8379	Mr. Riccobono
4 114	Mrs. Winter	872-3968	Mrs. Wasserman
5th Grade Representative	Kathy Messina, 285-9333		
5 116	Mrs. Mosca	825-0414	Miss Melzer
5 118	Mrs. Messina	285-9333	Mrs. Hamcke
5 122	Mrs. Kalakay	285-6073	Mr. Beyer
6th Grade Representative	Laura Panarelli, 825-7773		
6 121	Mrs. Panarelli	825-7773	Mrs. Seid
6 123-124	Mrs. Nickdow	285-4869	Mrs. Sherman &
	Mrs. Taranto	285-5477	Miss Lanell
6 125	Mrs. Delgado	872-0817	Mrs. Haydock
Special Class			
131	Mrs. Mizsak	872-0870	Miss Innella

JULY 1980

SUNDAY	MONDAY	TUESDAY	WEDNESDAY	THURSDAY	FRIDAY	SATURDAY
age is like a violin. After the beautiful is over, the strings are still attached.		1	2	3	4	5
		8	9	10	11	12
		C.H.S. Bd. of Ed. Mtg., 8:15 p.m.	16	17	18	19
		22	23	24	25	26
		Dist. No. 30 Bd. of Ed. Mtg., 8:15 p.m. (tentative)	30	31	A person is about as big as the things that make him angry. * * * Cooperation is doing with a smile what you have to do anyway.	

CLEAR STREAM AVENUE SCHOOL
CLASS MOTHER LIST

Class Mother Chairman Maureen Tkascik, 285-5562

FOREST ROAD SCHOOL
CLASS MOTHER LIST

Class Mother Chairmen
Roz Scheidt-Rhoda Levine

om	Class Mother	Tel. Number	Teacher		Gr.	Room	Class Mother	Tel. Number	Teacher				
9	Linda Arena	825-0563	Mrs. Murray	3	4	Nancy Jacob	825-0163	Mrs. Quinn	K	201	Estelle Henner	791-9019	Mrs.
9	Michele Feist	CU 5-7942	Mrs. Murray	3	4	Carol Seifert	285-7074	Mrs. Quinn	K	201	Priscilla Middleman	791-3797	Mrs.
9	Carol Lombardo	285-6473	Mrs. Murray	3	4	Joy Schuenhoff	872-9463	Mrs. Quinn	K*	201	Ronnie Ragona	791-5190	Mrs. Mellone
9	Nan O'Hara	285-7212	Mrs. Murray	4	24	Theresa Benedetto	285-5410	Mrs. Inwald	K	201	Lois Smollen	791-5703	Mrs. Mellone
9	Gail Barbato	285-9332	Mrs. Murray	4	24	Eileen Calandrino	825-6470	Mrs. Inwald	1	203	Maxine Grobman	561-7947	Miss Cafiso
9	Marie Frasca	285-4972	Mrs. Murray	4	24	Arlene Ercole	285-8127	Mrs. Inwald	1*	203	Donna Lobell	791-4568	Miss Cafiso
9	Marilyn Le Du	872-9644	Mrs. Murray	4	24	Florence Volpe	872-3517	Mrs. Inwald	2*	205	Sharon Bohmer	791-5367	Miss Perrich
9	Mary Ann McGullam	285-4614	Mrs. Murray	4	25	Julia Fiorentino	285-9628	Mr. Camilleri	2	205	Mary Eisenstein	791-8029	Miss Perrich
OL	Terry Bonomo	285-6240	Mrs. Maclean	4	25	Carolyn Leggio	825-6222	Mr. Camilleri	2	205	Gloria Feig	791-6315	Miss Perrich
OL	Ruth Fuimaro	825-5055	Mrs. Maclean	4	25	Marilyn Schneider	825-5350	Mr. Camilleri	2	205	Emid Parness	791-5960	Miss Perrich
OL	Madeline Schweigert	285-8823	Mrs. Maclean	4	25	Dottie Teichman	285-7108	Mr. Camilleri	3*	207	Dorothy Alpersen	791-2284	Mrs. Cummings
OL	Pat Torres	285-5676	Mrs. Maclean	5	8	Lia Finn	285-5094	Mrs. Stiefel	3	207	Karen Bing	825-0105	Mrs. Cummings
7	Rose Panza	285-4868	Mrs. Kalhofer	5	8	Fran Gentile	872-3206	Mrs. Stiefel	3	207	Edna Crescas	791-5972	Mrs. Cummings
7	Barbara McLaughlin	285-6162	Mrs. Kalhofer	5	8	Becky Sheil	CU 5-7779	Mrs. Stiefel	3	207	Louise Printz	791-6951	Mrs. Cummings
7	Maureen Richford	825-6518	Mrs. Kalhofer	5	8	Gerry Sullivan	561-8694	Mrs. Stiefel	3	207	Judy Orloff	791-3820	Mrs. Cummings
7	Cathy Wright	(212) 528-4255	Mrs. Kalhofer	5	23	Kay Diana	VA 5-5444	Miss Nancken	4	210	Sheila Boritz	791-9686	Mrs. Cabral
3	Faith Breiner	285-9887	Mrs. Ruschin	5	23	Joan Hollywood	285-6719	Miss Nancken	4	210	Gale Dancyger	791-2035	Mrs. Cabral
3	Carol Gergel	285-8519	Mrs. Ruschin	5	23	Barbara La Croce	825-8579	Miss Nancken	4	210	Felicia Katz	791-9501	Mrs. Cabral
3	Judy Trink	825-3123	Mrs. Ruschin	5	23	Mary Werkmeister	872-8987	Miss Nancken	4*	210	Rhoda Levine	791-3148	Mrs. Cabral
3	Doreen VonWerne	285-8586	Mrs. Ruschin	5	27	Diane Bruendl	285-7312	Mrs. Totten	4	210	Louise Wenzel	791-6354	Mrs. Cabral
6	Leanne Egan	825-8975	Mrs. Guberman	5	27	Kathy Cardalena	825-5431	Mrs. Totten	5	215	Pat Block	791-4920	Miss Schwartz
6	Mary Kajdacs	285-8457	Mrs. Guberman	5	27	Kathy Lynch	285-6490	Mrs. Totten	5	215	Alice Fischer	791-3824	Miss Schwartz
6	Aggie Poli	285-8317	Mrs. Guberman	5	27	Connie Magrino	285-7837	Mrs. Totten	5	218	Chang-Im Chung	791-3548	Miss Clarke
6	Aita Saputo	872-6521	Mrs. Guberman	6	21	Joan Bauer	285-5049	Mr. Cooper	5	218	Rita Kaplan	791-1695	Miss Clarke
B	Barbara Clarke	872-8415	Miss Post	6	21	Ann Leahy	872-3004	Mr. Cooper	5*	218	Lenora Paletz	791-5274	Miss Clarke
B	Patricia Duffy	(212) 276-1240	Miss Post	6	21	Kay McDonald	825-3313	Mr. Cooper	6	217	Trena Danels	791-1506	Mrs. Kessler
B	Gloria Piccoro	285-9658	Miss Post	6	21	Ruth Settepani	285-5725	Mr. Cooper	6	217	Helen Dickler	791-2771	Mrs. Kessler
B	Lou Ann Zollo	825-3581	Miss Post	6	22	Dotty Fusco	CU 5-5526	Miss Yelland	6	217	Elaine Sandler	791-5765	Mrs. Kessler
1	Delia Carrillo	285-4687	Miss Firpo	6	22	Beverly Jablonowski	825-2489	Miss Yelland	6	217	Betty Shea	791-2699	Mrs. Kessler
1	Mary Ann Sannicandro	825-6131	Miss Firpo	6	22	Rose Marceda	285-5341	Miss Yelland	6*	217	Roz Scheidt	791-9468	Mrs. Kessler
1	Ann Stoffa	285-4696	Miss Firpo	6	22	Gladys Sollitto	VA 5-3865	Miss Yelland	6	217	Linda Zahn	791-4516	Mrs. Kessler
1	Marie Trimboli	285-9023	Miss Firpo	6	28	Connie Canicatti	872-0899	Mrs. Harper	6	220	Jeryl DeNoie	791-4814	Mr. Lesser
2	Marion Acquavella	825-2272	Miss Schindelman	6	28	Fran Ciniglio	285-7996	Mrs. Harper	6	220	Joan Frischling	791-7663	Mr. Lesser
2	Rosalind Citrin	872-0414	Miss Schindelman	6	28	Rose Ann Petruzillo	285-4795	Mrs. Harper	6	220	Linda Harris	791-7827	Mr. Lesser
2	Cathy Collins	825-1159	Miss Schindelman	6	28	Rosemary Smith	561-8667	Mrs. Harper	6	220	Sandy Schaffer	872-0838	Mr. Lesser
2	Marge Rollo	825-0929	Miss Schindelman						6	220	Joan Solomon	791-4815	Mr. Lesser
4	Lucille Azari	872-3882	Mrs. Quinn						6	220	Sandy Train	791-8221	Mr. Lesser

AUGUST 1980

UNDAY	MONDAY	TUESDAY	WEDNESDAY	THURSDAY	FRIDAY	SATURDAY
					1	2
3	4	5	6	7	8	9
10	11	12	13	14	15	16
		C.H.S. Bd. of Ed. Mtg., 8:00 p.m.				
17	18	19	20	21	22	23
24	25	26	27	28	29	30
31		Dist. No. 30 Bd. of Ed. Mtg.,				

**VALLEY STREAM SCHOOL DISTRICT No. 30 AND
VALLEY STREAM HIGH SCHOOL
VALLEY STREAM, NEW YORK**

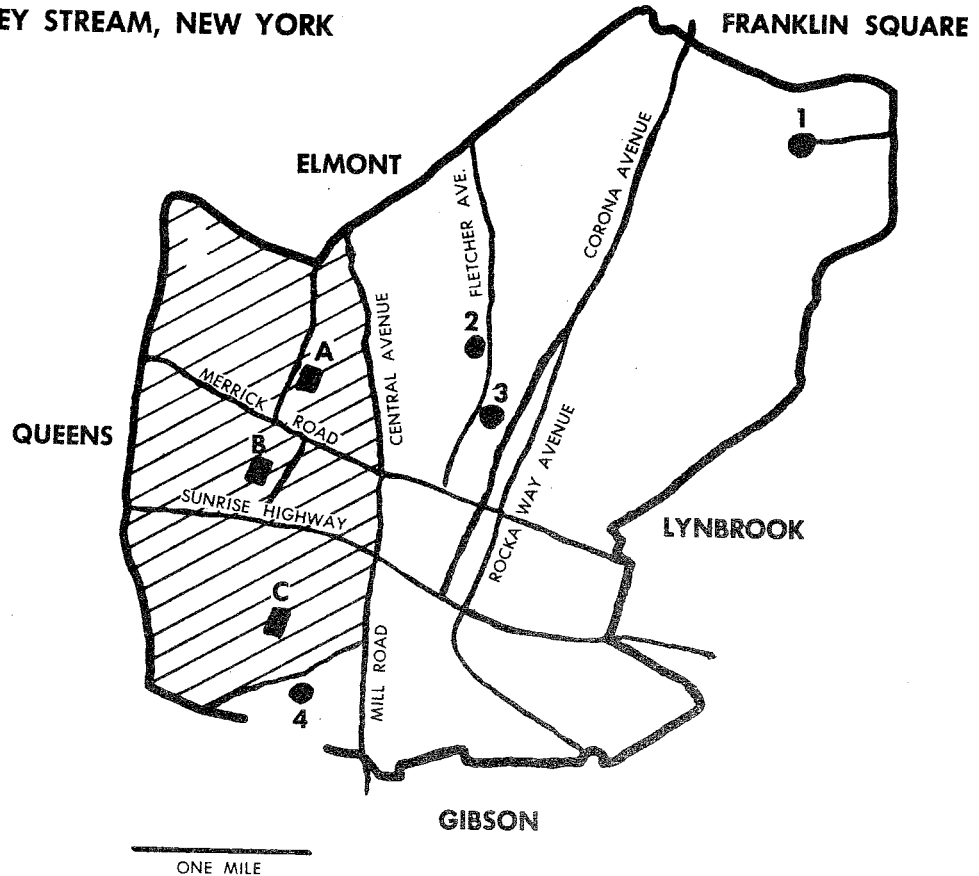

- DISTRICT No. 30 SCHOOLS**
- Shaw Avenue A
 - Clear Stream Avenue B
 - Forest Road C

Shaded Area — District 30

- HIGH SCHOOLS**
- North High 1
 - Memorial Junior 2
 - Central High 3
 - South High 4

SCHOOL TELEPHONE DIRECTORY

MAIN OFFICE: SHAW AVENUE SCHOOL

Principal's Office VA 5-9131

Nurse's Office VA 5-9131

Administrative Manager VA 5-9131

Shaw Avenue School

Principal's Office VA 5-9131

Nurse's Office VA 5-9131

Clear Stream Avenue School

Principal's Office VA 5-3044

Nurse's Office VA 5-3044

Special Services

Psychologist VA 5-9131

Speech Consultant VA 5-9131

Reading Consultant PY 1-7676

Audio-Visual Consultant 791-2225

Forest Road School

Principal's Office PY 1-7676

Nurse's Office PY 1-7676

INDEX

- Board of Education and School Calendar See October
- Administration and Special Services See November
- Clear Stream PTA See December
- Shaw Avenue PTA See January
- Forest Road PTA See February
- Monitoring Your Child's Education See March
- Raising Misfits See April
- School Policies See May and June
- Shaw Class Mothers See July
- Clear Stream and Forest Class Mothers See August
- Map of the District See Facing Page

VALLEY STREAM HIGH SCHOOL
Telephone Number: 824-2073
Use this number for all high school buildings, offices and personnel

NOTES

VALLEY STREAM UNION FREE SCHOOL
DISTRICT THIRTY

30

SCHOOL ACTIVITIES

Calendar

FOR 1979 - 1980

PUBLISHED BY THE BOARD OF EDUCATION AND PARENT-TEACHER ASSOCIATION

*Calendar of Events
1993-1994*

Valley Stream

Union Free School District Thirty

*Published by the Board of Education
and the
Parent Teacher Associations*

Board of Education

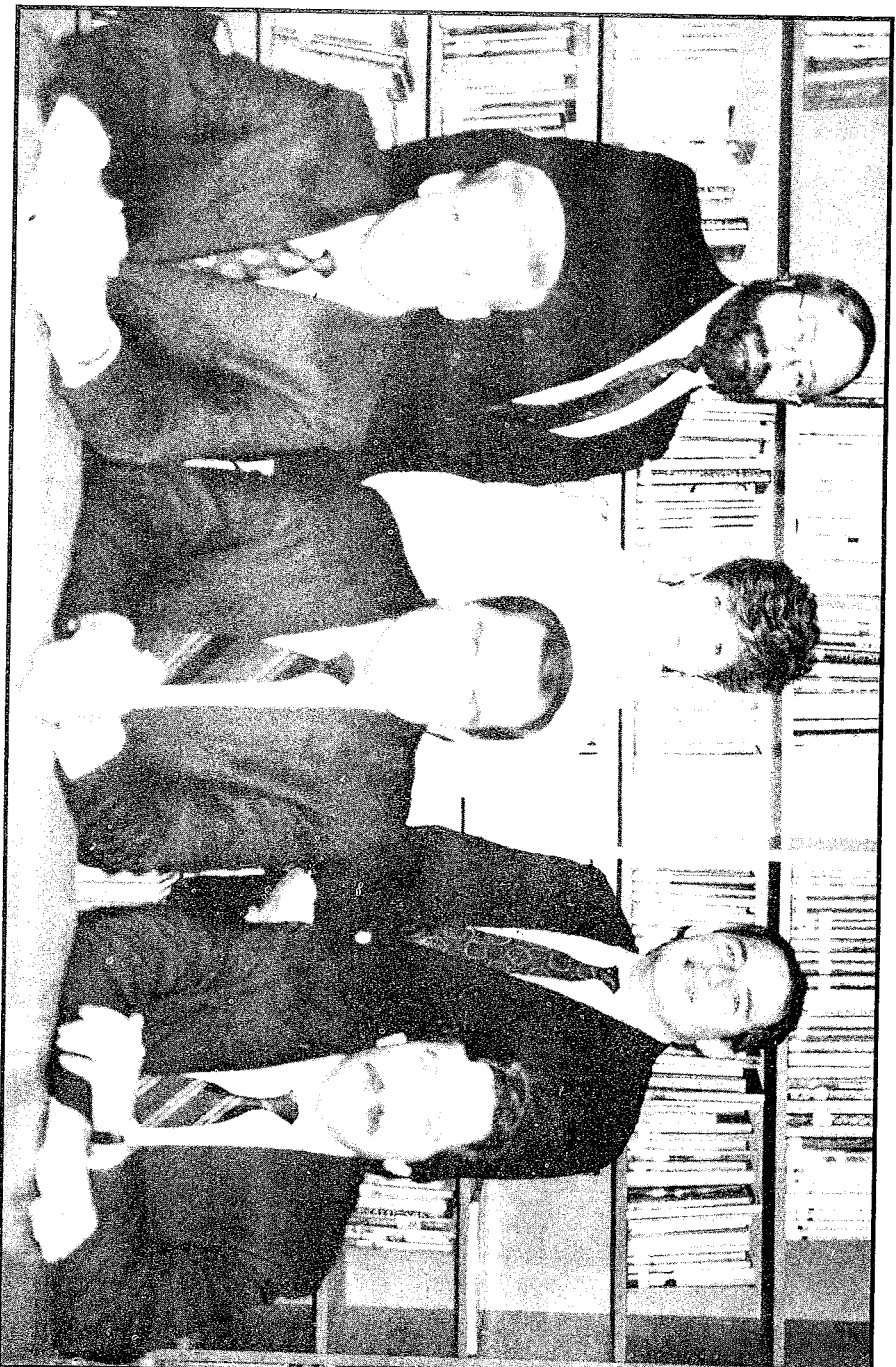

Standing (left to right): Andrew Walters, Trustee;
Seated (left to right): *William Gauger, President;
Richard Eisenberg, Trustee

*Leannore Egan, Trustee; *Thomas Galgano, Vice President;
Lawrence R. McGoldrick, Superintendent of Schools;

*Also serves on the High School Board

School Administration

Dr. Ira Singer, District Superintendent

Lawrence R. McGoldrick
Superintendent of Schools

David Kutcher
Asst. Supt. for Business

Dr. Raymond Brodeur, Jr.
Asst. Supt. for Curriculum & Student Svcs.

School Principals

Clear Stream Avenue School
Mr. Robert A. Cohen

Forest Road School
Dr. Barbara Warren Cronin

Shaw Avenue
Mr. Stanley Kaminsky

Director of Facilities
Gregory Abbate

Secretary to Superintendent
Madelaine Furst

School Secretaries

Lane Griffin, Clear Stream Avenue
Angela Nicolini, Forest Road
Anne Docar, Shaw Avenue

Secretarial Staff

Marilyn Berkowitz
Carol Blankshine
Elaine Faling
Lillian Grazian
Maude Henn
Mabel Horn
Grace Pisano
Marilyn Russo
Doris Stern

District Specialists and Special Teachers

Gerard Camilleri, Computer Coordinator
Dr. Lauraine Casella, Psychologist
Estelle Friedman, Psychologist
Dr. Jay Comcovich, Psychologist
Kim Jones-Sands, Learning Resource Teacher
June Innella, Learning Resource Teacher
Ronni Horowitz, Gifted & Talented Teacher
Concetta Madonna, Instrumental Music

Other Specialists and Special Teachers

Clear Stream Avenue School
Ann Glynn, Core Skills Teacher
Nancy Lowenkron, Core Skills Teacher
Amy Agnesini, Physical Education
Linda Pratt, Music
Alice Dorb, Library Media Specialist
Alyce Gardner, Nurse
Ralph Laudano, Science
Carolina Bertalli, ESL
Sharon Schulman, Speech Teacher
Forest Road School
Susan Baron, Art
Frances Gibson, Music
Vincent Manzo, Physical Education
Jill Luba, Speech Teacher
Carol Tolle, Library Media Specialist
Elaine Friedman, Nurse
Rene Herman, Reading Teacher
Ralph Laudano, Science
Carolina Bertalli, ESL
Shaw Avenue School
Laurie Silverman, Special Class Teacher
Catherine Wood, Special Class Teacher
Verna Brown, Special Counselor
Eugenie Melone, Core Skills Teacher
Linda Muckle, Art
Thomas Rouse, Physical Education
Joan Stein, Physical Education
Barbara Briker-Kreeger, Music
Mary Matthews, Library Media Specialist
Susan Lombardo, Nurse
Anne Marie Horner, Science Teacher
Rosemary Decker, Special Class Teacher
Gloria Weeks, Special Class Teacher
Patricia Phillips, Speech Teacher
Maria Marino Dove, ESL
Ada Keaney, Reading Teacher

School Telephone Directory

Main Office: Washington Avenue School

Superintendent 285-9881
 Business Office 285-9880
 Curriculum Office 285-9833

Clear Stream Avenue School

Principal's Office 872-4333
 Nurse's Office 872-4336

Forest Road School

Principal's Office 791-6134
 Nurse's Office 791-6790

Shaw Avenue School

Principal's Office 872-4320
 Nurse's Office 872-4327

Special Services

Computer Coordinator/AV Consultant..... 791-6375
 Committee for Special Education,
 Chairperson 285-9820
 Sp. Ed. Parent Reps. Mrs. Viggiano 791-3705
 Mrs. VonHarten 285-9532

Index

Board of Education Page 1
 District Staff Page 3
 Understanding Special Education Page 4
 General Information Page 5
 Weather Closings Page 5
 School Policies Pages 6 & 7
 Clear Stream PTA & Class Parent Page 8
 Forest Road PTA & Class Parent Page 9
 Shaw Avenue PTA & Class Parent Page 10
 Valley Stream Council of PTA's & SEPTA Page 11
 Monthly Calendars Pages 12 - 23

Valley Stream High School District

Central High School 561-4400
 Memorial Junior High School 872-7200
 North High School 564-5500
 South High School 791-0300

Valley Stream School District No. 30 and Valley Stream Central High School District Valley Stream, New York

District No. 30 Schools
 Shaw Avenue A
 Clear Stream Avenue B
 Forest Road C
 Washington Avenue D
 (District Office)

High Schools
 1 North High
 2 Memorial Jr. High
 3 Central High
 4 South High

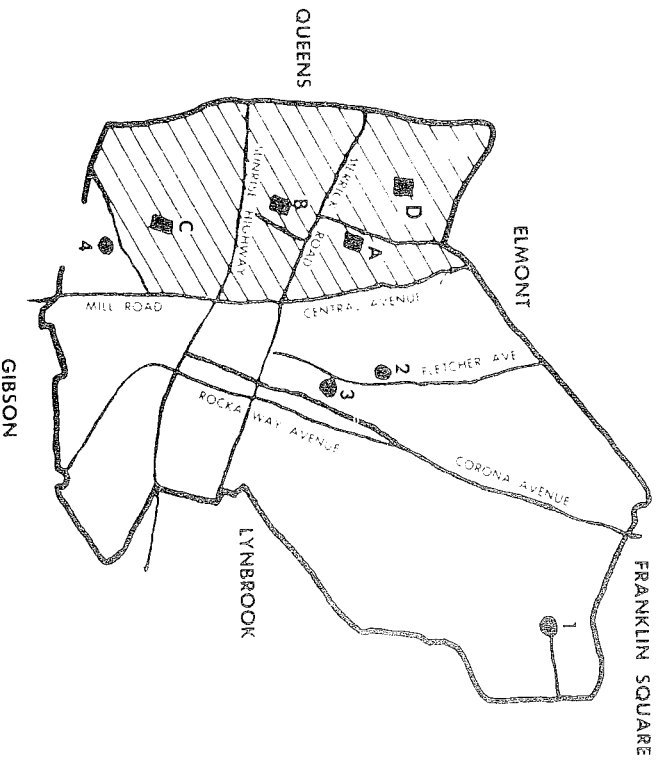

Calendar Preparation:

Dr. Barbara Cronin
 Angela Nicolini
 Gerard Camilleri (cover design)
 David Kutcher (student photos)

Understanding Special Education

Since the implementation in 1975 of Public Law 94-142, the Education for All Handicapped Children Act, the field of special education has undergone many changes. In District Thirty, the Special Education Program has been designed to provide students with appropriate education in the least restrictive environment and in conjunction with the most recent Commissioner's regulations. The programs, which are continually revised and updated, are based on the needs of the children within the district. All programs outlined are open to any student in the district for whom the Committee for Special Education feel the placement is appropriate.

A six-level program has been developed according to the severity of the handicap:

- I. Consultation - the student attends a regular classroom while the teacher supplements instruction with special materials for the students.
- II. Itinerant - special education teachers travel to the regular schools to provide special assistance to the student and classroom teacher.
- III. Resource Room - the student leaves the regular classroom to work on problem subject areas with a special education teacher in a resource room.
- IV. Self-Contained - the student works with a special education teacher in a classroom with special facilities, but which is housed in a regular school. This environment is available in district-wide classes.
- V. BOCES Special Education - the student's entire environment is geared toward special instruction with multiple support services.
- VI. Private School - when the handicap is beyond the previous five levels, the student attends a private school which specializes in special education.

Students are placed in one of the six-level programs only after careful screening by the Committee for Special Education. Then, to individualize the instruction for each student, his or her parents work with the teachers to develop an Individualized Education Program (I.E.P.).

As the program has grown to meet the individual needs of each child, it is difficult to dispute the value of education for all children in the district has increased. As the exceptional child benefits by learning in a non-disabled world, do too, the non-handicapped child benefits from the valuable opportunity to grow in his or her ability to accept individual differences, and to become more cooperative and compassionate.

Understanding Special Education

Since the implementation in 1975 of Public Law 94-142, the Education for All Handicapped Children Act, the field of special education has undergone many changes. In District Thirty, the Special Education Program has been designed to provide students with appropriate education in the least restrictive environment and in conjunction with the most recent Commissioner's regulations. The programs, which are continually revised and updated, are based on the needs of the children within the district. All programs outlined are open to any student in the district for whom the Committee for Special Education feel the placement is appropriate.

A six-level program has been developed according to the severity of the handicap:

- I. Consultation - the student attends a regular classroom while the teacher supplements instruction with special materials for the students.
- II. Itinerant - special education teachers travel to the regular schools to provide special assistance to the student and classroom teacher.
- III. Resource Room - the student leaves the regular classroom to work on problem subject areas with a special education teacher in a resource room.
- IV. Self-Contained - the student works with a special education teacher in a classroom with special facilities, but which is housed in a regular school. This environment is available in district-wide classes.
- V. BOCES Special Education - the student's entire environment is geared toward special instruction with multiple support services.
- VI. Private School - when the handicap is beyond the previous five levels, the student attends a private school which specializes in special education.

Students are placed in one of the six-level programs only after careful screening by the Committee for Special Education. Then, to individualize the instruction for each student, his or her parents work with the teachers to develop an Individualized Education Program (I.E.P.).

As the program has grown to meet the individual needs of each child, it is difficult to dispute the value of education for all children in the district has increased. As the exceptional child benefits by learning to function in a non-disabled world, do too, the non-handicapped child benefits from the valuable opportunity to grown in his or her ability to accept individual differences, and to become more cooperative and compassionate.

Vandalism

Vandalism costs money. Help us to reduce this drain on our tax dollars by keeping a watchful eye on your local school. Perhaps you have noticed persons on school grounds who were behaving suspiciously or actually engaged in vandalism, but you have not known where to call.

To report school vandalism or suspicious activities at your school, call the Nassau County Emergency Number 911. Give the name of the school, its location, and a brief description of what is happening. A police car will be radio-dispatched to investigate, and appropriate school personnel will be alerted. School officials will prosecute offenders whenever possible and attempt to secure restitution for damages.

Please report any of these activities:

- persons on the roof of the school
- anyone throwing objects at windows
- someone shooting weapons of any kind
- any kind of fire on school grounds
- destruction of grounds, shrubbery, or facility
- anyone operating mini-bikes on playgrounds or driveway
- any other suspicious or criminal acts

Use of School Facilities

The Board of Education encourages the use of school facilities for community purposes when such use does not interfere with the scheduled school program. Organizations desiring to use school facilities should request an 'Application for the Use of School Facilities' form from the principal of the school involved. Administrative rules and a statement of costs are explained on the application form.

School Visits

Parents are encouraged to visit school to meet the members of the professional staff, to examine the facilities, and instructional programs, and to share ideas. Those wishing to observe classes or to meet with staff members should arrange the visit in advance so that the time is appropriate and does not interfere with planned activities.

All visitors must register at the school office upon arrival, before visiting other parts of the building.

At dismissal times, parents picking up students are requested to meet them at a previously designated spot outside of the school. Dismissal exits have been assigned to classes in each building. Students are expected to leave the school building and school property in an orderly fashion at dismissal time each day. Such procedures are necessary to insure the safety of all students.

School Closings

Weather and other emergencies may warrant school closings. PTA Class Mothers will be informed and will initiate telephone calls to inform parents in each class. NEWS 12 on Channel 12 will carry school closing information. Such school closings will be also announced on the following local radio stations:

WCBS (AM) 88
WGGB (AM) 1240
WGSM (AM) 740

WALK (AM) 1370

WHLI (AM) 1100
WINS (AM) 1010
WALK (FM) 97.5

Vandalism

Vandalism costs money. Help us to reduce this drain on our tax dollars by keeping a watchful eye on your local school. Perhaps you have noticed persons on school grounds who were behaving suspiciously or actually engaged in vandalism, but you have not known where to call.

To report school vandalism or suspicious activities at your school, call the Nassau County Emergency Number 911. Give the name of the school, its location, and a brief description of what is happening. A police car will be radio-dispatched to investigate, and appropriate school personnel will be alerted. School officials will prosecute offenders whenever possible and attempt to secure restitution for damages.

Please report any of these activities:

- persons on the roof of the school
- anyone throwing objects at windows
- someone shooting weapons of any kind
- any kind of fire on school grounds
- destruction of grounds, shrubbery, or facility
- anyone operating mini-bikes on playgrounds or driveway
- any other suspicious or criminal acts

Use of School Facilities

The Board of Education encourages the use of school facilities for community purposes when such use does not interfere with the scheduled school program. Organizations desiring to use school facilities should request an 'Application for the Use of School Facilities' form from the principal of the school involved. Administrative rules and a statement of costs are explained on the application form.

School Visits

Parents are encouraged to visit school to meet the members of the professional staff, to examine the facilities, and instructional programs, and to share ideas. Those wishing to observe classes or to meet with staff members should arrange the visit in advance so that the time is appropriate and does not interfere with planned activities.

All visitors must register at the school office upon arrival, before visiting other parts of the building.

At dismissal times, parents picking up students are requested to meet them at a previously designated spot outside of the school. Dismissal exits have been assigned to classes in each building. Students are expected to leave the school building and school property in an orderly fashion at dismissal time each day. Such procedures are necessary to insure the safety of all students.

School Closings

Weather and other emergencies may warrant school closings. PTA Class Mothers will be informed and will initiate telephone calls to inform parents in each class. NEWS 12 on Channel 12 will carry school closing information. Such school closings will be also announced on the following local radio stations:

WCBS (AM) 88
WGBB (AM) 1240
WGSM (AM) 740

WHLI (AM) 1100
WINS (AM) 1010
WALK (FM) 97.5

WALK (AM) 1370

School Policies

Homework Requirements

Classroom learning is improved through effective homework assignments. Homework may include review, reinforcement, reading in preparation for classroom discussion, analysis and research. Homework helps students establish work habits which will influence their use of time throughout life. Homework is required of all pupils, but it will vary from day to day. First and second grade pupils may have fifteen to twenty minutes of homework per day, while third and fourth grade pupils are likely to have thirty to forty minutes. Fifth and sixth graders are expected to devote as much as an hour to homework, but again this may not be every day - it will depend on the pupil and his/her needs. Students should require little if any help from parents in completing assignments. However, parents may assist students by insuring that they have a quiet, comfortable place to work.

Lost and Found

Unmarked articles lost by pupils are placed in the Lost-and-Found, which is in the Nurse's Office at Clear Stream, Shaw and Forest. Such articles, if not claimed at the end of the school year, are given to a charitable organization. However, any article bearing a child's name is returned directly to him/her. Please place your child's name on all his/her belongings.

Assemblies

When your child's class puts on an assembly program, we welcome your attendance, but we do ask you not to bring pre-school children. As much as we realize that it is a thrill for them to see older siblings perform, they are often distracting to all concerned. Picture taking is not allowed without prior approval.

Medication

Under certain unusual circumstances, when it is necessary for the child to take internal medication during school hours, the nurse may cooperate with the family physician and the parents. If the parent submits a written request to the school authorities and it is accompanied by a written request from the family physician in which s/he indicates the frequency and dosage of a prescribed medication, then the school nurse may administer this medication during the school hours. Under no circumstances will a child be permitted to carry or to take medication by himself or herself.

Physical Education Attire and Sneakers

No special clothing is required, but sneakers are necessary for any pupils using the gym. Boys and girls are required to wear gym attire and sneakers on assigned gym days. The PE teachers will explain this to the pupils, but many times they do not bring the correct information home. **NO ONE IS ALLOWED ON THE GYM FLOOR WITHOUT SNEAKERS.**

Appointments with Teachers

In order that pupils' class time be used to the fullest advantage, we request that parents do not seek conferences with teachers during school hours. If you wish a conference, please make an appointment to see the teacher after school. Teachers are available for such conferences every day except Wednesdays and Fridays.

Bicycles

NO bicycles are allowed at either Forest Road or Clear Stream Avenue Schools because no child lives far enough from the school to make them necessary. They are allowed at Shaw, but are restricted to pupils in grades 4, 5, and 6 who live NORTH OF FOSTER AVENUE. All must have a lock and chain for safety purposes.

Gifts to Teachers Prohibited

The policy of the school district which became effective January 1956, is to prohibit the acceptance of gifts by faculty members on school premises, and to prohibit the solicitation of funds for personal gifts purposes, by any person, or persons, on the premises.

In-Day Program

In inclement weather, there is an in-day program of motion pictures or quiet games provided for those pupils who eat in the cafeteria. Pupils who go home to lunch are not allowed to participate in this program because of space limitations, so we ask parents to return these pupils to school on such days just in time for the afternoon session - not before five minutes prior to their scheduled lunch time.

School Policies

School Hours for all Schools

Kindergarten to Grade 6, including Special Classes: 8:30 a.m. to 2:45 p.m.

Breakfast

Students participating in the Breakfast Program at Forest Road School should not arrive before 7:55 a.m. Supervision is not provided for students prior to that time.

Lunch

Lunch is served beginning with the first day of school. Pupils may go home for lunch, bring lunch from home, or buy the school lunch in the cafeteria. Students are not permitted to leave school for lunch unless picked up by a parent or authorized adult. Monthly menus are provided so that if foods are served which your child does not eat, you can make other provisions for him/her for those days. In case a child forgets his/her lunch money, or loses either, we have a charge system to cover the emergency, except the week before summer vacation. The secretary keeps the record of such charges and contacts the parents should a charge not be paid in a reasonable time. Students may now purchase prepaid lunch tickets. Each ticket provides 20 meals, and is valid until June 24th, or until all 20 meals are used. All tickets will remain with the Cafeteria Cashier, so there is no chance for a child to lose his or her lunch money. Please make checks payable to the Valley Stream CHS District. For further information, contact our Business Office at 285-9880.

Ice Cream

Ice cream is sold daily to those pupils who wish it. It is not part of the hot lunch and costs additional.

Recess Milk

Recess milk is available to all children beginning about the third week of the school year and is sold at a cost per week payable each Thursday for the following week. You will be notified as to exact date. Money brought in late (Friday) cannot be accepted. In case of a child's absence, no refund is made for period of less than a full week.

Absences

When your child has been absent, State law requires that he/she bring a note from you explaining the absences and the date(s) of absence(s). The note should be presented to the nurse before he/she goes to the classroom. Please

be specific. Just saying, "he/she was ill", is not enough. Indicate whether it was "virus", "fever", "cold", etc.

A note is required for an absence due to a religious holiday. A note is required for any tardiness, giving the reason. If your child contacts a contagious disease, such as mumps, measles, etc., please phone the school nurse so that she can alert the parents in your child's class that their children have been exposed. Be sure to keep the emergency card up to date so that we will know whom to call should your child become ill and have to go home.

Noon Hour Rules

When pupils misbehave in the cafeteria, auditorium, or on the playground during the noon hour, after repeated reminders, the teachers have the authority to exclude them from staying in school for lunch for a few days, or longer, depending on the misbehavior. If you receive such a note from us, we would appreciate your cooperation. Whether or not a parent is home during the noon hour has no bearing on this exclusion.

Exits and Entrances

Your child's class is assigned a specific exit and entrance to use. You will thus know where to meet him/her when you come to pick up. Parents picking up children are asked to meet them at the exit, not the classroom. Parents must wait outside the school at dismissal time.

A.M. Entrance Times

All Schools: Grades K to 6 - 8:20 a.m.

Because there is no supervision of the playground in the morning, we suggest you arrange your child's departure from home to allow him/her to arrive just in time to enter the building during the proper interval. In inclement weather he/she may come into the designated area five minutes before the above times.

Class Interruptions

No unnecessary interruptions of classes are allowed once the day's sessions have begun. When your child forgets a book, homework, sneakers, lunch money, etc., please bring these to the office. All pupils are instructed to check with the office at lunch time for such forgotten items. In the interest of the child's all-round education, we urge you not to make a practice of bringing forgotten items to school. The child should be developing his/her own sense of responsibility for these things.

Positions

Co-Presidents
 1st Vice Pres.
 (Program)
 2nd Vice Pres.
 (Pre-School)
 3rd Vice Pres.
 (Ways & Means)
 Hon. Vice Pres.
 Treasurer
 Membership
 Rec. Secretary
 Corr. Sec'y.
 Del. to Council
 Past Pres.

Elected Officers
 Valerie Campolo
 Peggy Robinson
 Sandee Kinzer
 Rosann DiPalma
 Cathy Montefusco
 Robert Cohen
 Linda Lockspeiser
 Kathy Russo
 Bernadette Lakovits
 Carole Belmonte
 Gert Marrero
 Amy Agnesini
 Barbara Clarke
 Joanne Spano

PARP
 Pumpkin Patch
 Reflections
 Seniors as Reading Vol.
 Supermarket Bingo
 T-Shirt Sale
 Teacher Recognition

Fran Lozano
 Vivian Martingano
 Sandee Kinzer
 Irene Costanza
 Cathy Montefusco
 Pat McCormick
 Peggy Riccio
 Joanie Ochman
 Gert Marrero
 Ginny Mundy

2-9570
 568-1946
 825-8421
 561-2086
 561-7170
 285-8618
 285-8140
 872-0498
 285-4186
 unlisted

Class Parent List

Grade
Kdgn. Grade Rep.

Class Parent
 Rosann DiPalma
 Irene Costanza
 MaryAnn Lanz
 Carol Mallese
 Rosemary Miller
 Susan Pingaro
 Magret Robar
Antoinette Randazzo
 Terese Maher
 Ruth Palazzolo
 Fran Lozano
 Maria Visone
 Lorraine Biondolillo
 Zanazan Antramik
 Mary Sheffield
 Anna Albanese
 Cathy Singer
 Anita Albert
 Cathy Montefusco
Linda Bastardi
 Paula Imperial
 Terri Lusenskas
 Sandee Kinzer
 Olga Rios
 Gloria Sciara
 Veronica Yellico
Joanne Spano
 Nancy Wasek
 Juliet Manger
 Dawn Renner
 Toni Fusco
Bernadette Lakovits
 Sara Makarewicz
 Vivian Martingano
 Joan Ochman
 Fran D'Alessio
 JoAnne Novello
 Jean Taormina
Cynthia Dattoli
 Al Hay
 Pat McCormick
 Ginny Mundy
 Kathy Russo
 Alicia Garcia
 Gina Hayden
 Carol Moore
 Faye Riccardio

Teacher
 Libertini/Fariel
 Libertini/Fariel
 Libertini/Fariel
 Libertini/Fariel
 Libertini/Fariel
 Libertini/Fariel
 Franklin
 Franklin
 Sacks
 Sacks
 Ventura
 Ventura
 Lopez
 Lopez
 Murray
 Murray
 Cabral
 Cabral
 Maclean
 Maclean
 Spiess
 Spiess
 Clarke
 Clarke
 Ehrenreich
 Ehrenreich
 Catalano
 Catalano
 Catalano
 Yelland
 Yelland
 Yelland
 Yelland
 Cooper
 Cooper
 Cooper
 Cooper
 Goldberg
 Goldberg
 Goldberg
 Goldberg

Tel. Number
 285-4036
 561-2086
 285-7068
 285-8197
 872-3224
 568-9144
 285-5321
 285-5129
 561-5513
 285-4539
 872-9570
 561-8846
 825-7271
 568-9840
 285-6221
 561-8468
 872-1338
 285-5523
 561-7170
 285-9229
 561-6083
 872-0557
 825-8421
 285-4757
 872-8062
 285-4869
 285-6690
 285-7201
 285-8246
 825-2942
 285-1148
 825-1827
 568-0171
 568-1946
 872-0498
 825-8621
 872-8229
 568-0175
 285-9715
 561-0649
 285-8618
 unlisted
 872-9393
 718-525-3958
 285-7151
 825-1189
 285-8360

Executive Board Standing Committee Chairpersons

Arts & Flyers
 Auditing Comm.
 Chime Liasion
 Cultural Arts
 Cul.Arts Liasion
 Historian/Publicity
 Hospitality
 KARE
 KARE
 Legislation
 Nutrition
 Procedures
 Safety Committee
 School & Community
 Special Ed. Liasion
 Streamer

Suzanne Leitstein
 Sandee Kinzer
 Mary Sheffield
 Mary Maclean
 Helene Zemel
 Joanne Spano
 Alice Swahn
 Veronica Yellico
 Alice Swahn
 Direct.#
 Linda Bastardi
 Bernadette Lakovits
 Cathy Montefusco
 Bernadette Lakovits
 Pat McCormick
 Kathy Russo
 Lori Weisblatt
 Suzanne Leitstein

1st Grade Rep.
 285-0403
 825-8421
 285-6221
 Faculty
 872-2642
 285-6690
 285-8626
 285-4869
 285-8626
 823-0026
 285-9229
 825-1827
 561-7170
 825-1827
 285-8618
 872-9393
 285-7121
 285-0403

Special Committee Chairpersons

Bd. of Ed. Appreciation
 Book Fair
 Breakfast w/Santa
 Candy & Giftwrap Sale
 Cupcake Sale
 Dance (Valentine's)
 Father's Day Boutique
 Fashion Show
 Fingerprinting
 Holiday/Craft Boutique
 Kid's Show

Executive Committee
 Delia Doino
 Sara Makarewicz
 Sandee Kinzer
 Rosann DiPalma
 Sandee Kinzer
 Carol Mallese
 Antoinette Randazzo
 Carol Mallese
 Cathy Montefusco
 Joanie Ochman
 Peggy Robinson
 Carole Belmonte
 Linda Lockspeiser
 Joann Novello
 Antoinette Randazzo

5th Grade Rep.
 825-3571
 568-0171
 825-8421
 285-4036
 825-8421
 285-8197
 285-5129
 285-8197
 561-7170
 872-0498
 285-4986
 285-6267
 285-5227
 872-8229
 285-5129

6th Grade Rep.
 825-3571
 568-0171
 825-8421
 285-4036
 825-8421
 285-8197
 285-5129
 285-8197
 561-7170
 872-0498
 285-4986
 285-6267
 285-5227
 872-8229
 285-5129

Forest Road Parent Teacher Association 1993-1994

Positions

Co-Presidents
 1st Vice President
 2nd Vice President
 3rd Hon. Vice Pres.
 Treasurer
 Rec. Secretary
 Financial Secretary
 Corr. Secretary
 Past Pres.
 Teacher Representative

Elected Officers

Maria Fletcher
 Laura Silverman
 Nancy Jeuda
 (Ways & Means)
 Colleen Hickey
 (Programming)
 Dr. Barbara Cronin
 Charlotte Lurie
 Robin Laurentz
 Karen Jacobson
 Ann Falley
 Susan Viggiano
 Linda Kessler

Telephone No.

791-3719
 791-4928
 791-4869
 791-4479
 791-6134
 791-8662
 791-3765
 791-1278
 791-6231
 791-3705
 791-6134

Executive Board Standing Committee Chairpersons

Administrative Committees
 Del. to Council
 Flyer Distribution
 Flyers
 Historian
 Legislation
 Safety
 Newsletter
 School Board Rep.
 Chime Rep.
 Nutrition Rep.
 6th Gr. Yearbook
 Holiday Brunch
 Teacher Recognition
 Hospitality
 Class Mother
 Co-ordinators
 40th Birthday
 Celebration
Programming Committees
 Committee Chairperson
 Reflections
 PARR
 Family Living
 Pre-School
 Birthday Calendar
 Field Day
Fundraising Committees
 Chairperson
 Adult Bingo
 Book Fair
 Candy Sale

Holly Bobrow
 Bonnie Magaril
 Laura Silverman
 Robin Laurentz
 Laura Silverman
 Robin Laurentz
 Maria Fletcher
 Karen Benison
 Joyce Seelig
 Maria Fletcher
 Marilyn LeCort
 Jane Kiviat
 Ann Falley
 Ruth Klein
 Bonnie Magaril
 Cathy Hicks
 Lisa Vogel
 Charlotte Lurie
 Alison Smith
 Kathy Hicks
 Lisa Vogel
 Penny Eisenberg
 Robin Laurentz
 Carol Phillips
 Maria Fletcher
 Laura Silverman
 Alison Smith
 Susan Viggiano
 Colleen Hickey
 Alison Smith
 Susan Viggiano
 Robin Laurentz
 Ely Haber
 Ellen Hershey
 Joanne Ferraioli
 Cathy Hicks
 Mindy Ram
 Sharon Hirth
 Ali Friedman
 Robin Laurentz
 Jill Cohen
 Alison Smith
 Sharon Hirth
 Bonnie Magaril

Carnival

Fashion Show

Gift Wrap Sale

Kids Bingo

Holiday Boutique

Plant Sale

Pumpkin Sale

Raffles

Sox Hop

Summer Book Fair

T-Shirt Sale

Sharon Hirth
 Nancy Jeuda
 Laura Feaser
 Lynn Smolin
 Holly Bobrow
 Nancy Jeuda
 Mimi Epstein
 Mona Schantz
 Vicki Shapiro
 Janice Brown
 Karen Jacobson
 Carol Phillips
 Holly Bobrow
 Sharon Hirth
 Ely Haber
 Colleen Hickey
 Debbie Cohan
 Ely Haber
 Susan Viggiano
 Ellen Hershey
 Joyce Seelig
 Sharon Hirth

791-5142
 791-4869
 791-5904
 791-6136
 791-5749
 791-4869
 791-8103
 791-7902
 791-9577
 791-9168
 791-1278
 791-2054
 791-5749
 791-5142
 791-1293
 791-4479
 825-3118
 791-1293
 791-3705
 791-7290
 791-5191
 791-5142

Class Parent List (*Grade Rep.)

Grade	Class Mother	Rel. Number	Teacher	Room
Kdg.	*Andrea Spector	791-1453	Scheidt	201
Kdg.	Ellen Popper	791-6276	Moskowitz	202
1st	Valerie Gensheimer	791-5998	Wakely	203
1st	*Cathy Hicks	825-1858	Barry	204
2nd	Lynn Smolin	791-6136	Ruschin	205
2nd	Jill Cohen	791-3704	Patterson	206
2nd	*Michelle Feinstein	791-9890	Guttman	207
2nd	June Goldman	791-2666	Maresca	209
3rd	Sherry Galvin	791-6502	Fitzgerald	210
3rd	*Ely Haber	791-1293	Stiefel	211
3rd	Laura Silverman	791-4928	Lewis	212
3rd	Lisa Stanley	872-2716	Walsh	216
3rd	*Karen Benison	791-1845	Lesser	217
3rd	Lynn Fishman	791-5347	Kessler	220
3rd	Debbie Cohan	825-3118	Silverman	208
3rd	*Joanne Ferraioli	791-7232	Wood	215A
3rd	Alison Smith	791-6028		
3rd	*Robin Laurentz	791-3765		
3rd	Janet Bleier	791-2054		
3rd	Ann Tenzer	791-4353		
3rd	*Theresa Siedlick	791-8857		
3rd	Sheryl Weiner	791-1530		
3rd	Christine Bailot	791-2813		
3rd	*Janice Brown	791-8446		
3rd	Sharon Hirth	791-9168		
3rd	*Lisa Vogel	791-5142		
3rd	Colleen Hickey	568-1901		
3rd	*Holly Bobrow	791-4479		
3rd	Nancy Jeuda	791-4869		
3rd	*Debbie Orena	791-7951		
3rd	Penny Eisenberg	791-8109		
3rd	Shelly Salomon	791-8920		
3rd	*Mariene Owen	791-7075		
3rd	Tina Verasco	791-7198		
3rd	Alicia Barreto	791-2019		
3rd	*Ellen Shurgan	791-9349		
3rd	Jane Kiviat	791-3252		
3rd	*Diane Rensing	791-7752		
3rd	*Elaine Klein	285-8504		
3rd		791-7523		

School Policies

Physical Education Attire and Sneakers

No special clothing is required, but sneakers are necessary for any pupils using the gym. Boys and girls are required to wear gym attire and sneakers on assigned gym days. The PE teachers will explain this to the pupils, but many times they do not bring the correct information home. **NO ONE IS ALLOWED ON THE GYM FLOOR WITHOUT SNEAKERS.**

Appointments with Teachers

In order that pupils' class time be used to the fullest advantage, we request that parents do not seek conferences with teachers during school hours. If you wish a conference, please make an appointment to see the teacher after school. Teachers are available for such conferences every day except Wednesdays and Fridays.

Bicycles

NO bicycles are allowed at either Forest Road or Clear Stream Avenue Schools because no child lives far enough from the school to make them necessary. They are allowed at Shaw, but are restricted to pupils in grades 4, 5, and 6 who live NORTH OF FOSTER AVENUE. All must have a lock and chain for safety purposes.

Gifts to Teachers Prohibited

The policy of the school district which became effective January 1956, is to prohibit the acceptance of gifts by faculty members on school premises, and to prohibit the solicitation of funds for personal gifts purposes, by any person, or persons, on the premises.

In-Day Program

In inclement weather, there is an in-day program of motion pictures or quiet games provided for those pupils who eat in the cafeteria. Pupils who go home to lunch are not allowed to participate in this program because of space limitations, so we ask parents to return these pupils to school on such days just in time for the afternoon session - not before five minutes prior to their scheduled lunch time.

Homework Requirements

Classroom learning is improved through effective homework assignments. Homework may include review, reinforcement, reading in preparation for classroom discussion, analysis and research. Homework helps students establish work habits which will influence their use of time throughout life. Homework is required of all pupils, but it will vary from day to day. First and second grade pupils may have fifteen to twenty minutes of homework per day, while third and fourth grade pupils are likely to have thirty to forty minutes. Fifth and sixth graders are expected to devote as much as an hour to homework, but again this may not be every day - it will depend on the pupil and his/her needs. Students should require little if any help from parents in completing assignments. However, parents may assist students by insuring that they have a quiet, comfortable place to work.

Lost and Found

Unmarked articles lost by pupils are placed in the Lost-and-Found, which is in the Nurse's Office at Clear Stream, Shaw and Forest. Such articles, if not claimed at the end of the school year, are given to a charitable organization. However, any article bearing a child's name is returned directly to him/her. Please place your child's name on all his/her belongings.

Assemblies

When your child's class puts on an assembly program, we welcome your attendance, but we do ask you not to bring pre-school children. As much as we realize that it is a thrill for them to see older siblings perform, they are often distracting to all concerned. Picture taking is not allowed without prior approval.

Medication

Under certain unusual circumstances, when it is necessary for the child to take internal medication during school hours, the nurse may cooperate with the family physician and the parents. If the parent submits a written request to the school authorities and it is accompanied by a written request from the family physician in which s/he indicates the frequency and dosage of a prescribed medication, then the school nurse may administer this medication during the school hours. Under no circumstances will a child be permitted to carry or to take medication by himself or herself.

School Policies

School Hours for all Schools

Kindergarten to Grade 6, including Special Classes: 8:30 a.m. to 2:45 p.m.

Breakfast

Students participating in the Breakfast Program at Forest Road School should not arrive before 7:55 a.m. **Supervision is not provided for students prior to that time.**

Lunch

Lunch is served beginning with the first day of school. Pupils may go home for lunch, bring lunch from home, or buy the school lunch in the cafeteria. **Students are not permitted to leave school for lunch unless picked up by a parent or authorized adult.** Monthly menus are provided so that if foods are served which your child does not eat, you can make other provisions for him/her for those days. In case a child forgets his/her lunch money, or loses either, we have a charge system to cover the emergency, except the week before summer vacation. The secretary keeps the record of such charges and contacts the parents should a charge not be paid in a reasonable time. Students may now purchase prepaid lunch tickets. Each ticket provides 20 meals, and is valid until June 24th, or until all 20 meals are used. All tickets will remain with the Cafeteria Cashier, so there is no chance for a child to lose his or her lunch money. Please make checks payable to the Valley Stream CHS District. For further information, contact our Business Office at 285-9880.

Ice Cream

Ice cream is sold daily to those pupils who wish it. It is **not** part of the hot lunch and costs additional.

Recess Milk

Recess milk is available to all children beginning about the third week of the school year and is sold at a cost per week payable each Thursday for the following week. You will be notified as to exact date. Money brought in late (Friday) cannot be accepted. In case of a child's absence, no refund is made for period of less than a full week.

Absences

When your child has been absent, State law requires that he/she bring a note from you explaining the absences and the date(s) of absence(s). The note should be presented to the nurse **before** he/she goes to the classroom. Please

be specific. Just saying, "he/she was ill", is not enough. Indicate whether it was "virus", "fever", "cold", etc.

A note is required for an absence due to a religious holiday. A note is required for any tardiness, giving the reason. If your child contacts a contagious disease, such as mumps, measles, etc., please phone the school nurse so that she can alert the parents in your child's class that their children have been exposed. Be sure to keep the emergency card up to date so that we will know whom to call should your child become ill and have to go home.

Noon Hour Rules

When pupils misbehave in the cafeteria, auditorium, or on the playground during the noon hour, after repeated reminders, the teachers have the authority to exclude them from staying in school for a few days, or longer, depending on the misbehavior. If you receive such a note from us, we would appreciate your cooperation. Whether or not a parent is home during the noon hour has no bearing on this exclusion.

Exits and Entrances

Your child's class is assigned a specific exit and entrance to use. You will thus know where to meet him/her when you come to pick up. Parents picking up children are asked to meet them at the exit, **not** the classroom. Parents must wait outside the school at dismissal time.

A.M. Entrance Times

All Schools: Grades K to 6 - 8:20 a.m.
Because there is no supervision of the playground in the morning, we suggest you arrange your child's departure from home to allow him/her to arrive just in time to enter the building during the proper interval. In inclement weather he/she may come into the designated area five minutes before the above times.

Class Interruptions

No unnecessary interruptions of classes are allowed once the day's sessions have begun. When your child forgets a book, homework, sneakers, lunch money, etc., please bring these to the office. All pupils are instructed to check with the office at lunch time for such forgotten items. In the interest of the child's all-round education, we urge you not to make a practice of bringing forgotten items to school. The child should be developing his/her own sense of responsibility for these things.

Clear Stream Avenue Parent Teacher Association 1993-94

Positions	Elected Officers	Telephone
Co-Presidents	Valerie Campolo	285-6345
	Peggy Robinson	285-4986
1st Vice Pres. (Program)	Sandee Kinzer	825-8421
2nd Vice Pres. (Pre-School)	Rosann DiPalma	285-4036
3rd Vice Pres. (Ways & Means)	Cathy Montefusco	561-7170
Treasurer	Robert Cohen	872-4333
Memberships	Linda Lockspeiser	285-5227
Rec. Secretary	Kathy Russo	872-9393
Corr. Secty.	Bernadette Lakovits	825-1827
Del. to Council	Carole Belmonte	285-6267
	Gert Marrero	285-4186
	Amy Agnesini	Faculty
	Barbara Clarke	Faculty
	Joanne Spano	285-6690
Past Pres.		

Executive Board Standing Committee Chairpersons

Arts & Flyers	Suzanne Leitstein	285-0403
Auditing Comm.	Sandee Kinzer	825-8421
Chime Liaison	Mary Sheffield	285-6221
Cultural Arts	Mary Maclean	Faculty
Cul. Arts Liaison	Helene Zernel	872-2642
Historian/Publicity	Joanne Spano	285-6690
Hospitality	Alice Swahn	285-8626
KARE	Veronica Yellico	285-4889
KARE	Alice Swahn	285-8626
Legislation	Direct. #	823-0026
Nutrition	Linda Bastardi	285-9229
Procedures	Bernadette Lakovits	825-1827
Safety Committee	Cathy Montefusco	561-7170
School & Community	Bernadette Lakovits	825-1827
Special Ed. Liaison	Pat McCormick	285-8618
Streamer	Kathy Russo	872-9393
	Lori Weisblatt	285-7121
	Suzanne Leitstein	285-0403

Special Committee Chairpersons

Bd. of Ed. Appreciation	Executive Committee	825-3571
Book Fair	Della Doio	568-0171
Breakfast w/Santa	Sara Makarewicz	825-8421
Candy & Giftwrap Sale	Sandee Kinzer	825-4036
Cupcake Sale	Rosann DiPalma	825-8421
Dance (Valentine's)	Sandee Kinzer	285-8197
Father's Day Boutique	Carol Maltese	285-5129
Fashion Show	Antoinette Randazzo	285-8197
Fingerprinting	Carol Maltese	561-7170
Holiday/Craft Boutique	Cathy Montefusco	872-0498
Kid's Show	Joanie Ochman	285-4986
	Peggy Robinson	285-6267
	Carole Belmonte	872-8229
	Linda Lockspeiser	285-5129
	Joann Novello	561-7170
	Antoinette Randazzo	872-0498

Class Parent List

Grade	Class Parent	Tel. Number	Teacher
Kdgn. Grade Rep.	Rosann DiPalma	285-4036	Libertini/Fariel
	Irene Costanza	561-2086	Libertini/Fariel
	MaryAnn Lanz	285-7068	Libertini/Fariel
	Carol Maltese	285-8197	Libertini/Fariel
	Rosemary Miller	872-3224	Libertini/Fariel
	Susan Pingaro	568-9144	Libertini/Fariel
	Magret Robar	285-5321	Libertini/Fariel
	Antoinette Randazzo	285-5129	Franklin
	Terese Maher	561-5513	Franklin
	Ruth Palazzolo	285-4539	Sacks
	Fran Lozano	872-9570	Sacks
	Maria Visone	561-8846	Ventura
1st Grade Rep.	Lorraine Biondolillo	825-7271	Ventura
	Zanazan Antranik	568-9840	Lopez
	Mary Sheffield	285-6221	Lopez
	Anna Albanese	561-8468	Murray
	Cathy Singer	872-1338	Murray
	Anita Albert	285-5523	Murray
	Cathy Montefusco	561-7170	Cabral
	Linda Bastardi	285-9229	Cabral
	Paula Imperial	561-6083	Maclean
	Terri Lusenskias	872-0557	Maclean
	Sandee Kinzer	825-8421	Spiess
	Olga Rios	285-4757	Spiess
2nd Grade Rep.	Gloria Sciara	872-8062	Clarke
	Veronica Yellico	285-4889	Clarke
	Joanne Spano	285-6690	Ehrenreich
	Nancy Wasek	285-7201	Ehrenreich
	Juliet Manger	285-8246	Catalanoito
	Dawn Renner	825-2942	Catalanoito
	Toni Fusco	285-1148	Catalanoito
	Bernadette Lakovits	825-1827	Yelland
	Sara Makarewicz	568-0171	Yelland
	Vivian Martingano	568-1946	Yelland
	Joan Ochman	872-0498	Cooper
	Fran D'Alessio	825-8621	Cooper
3rd Grade Rep.	JoAnne Novello	872-8229	Cooper
	Jean Taormina	568-0175	Cooper
	Cynthia Dattoli	285-9715	Goldberg
	Al Hay	561-0649	Goldberg
	Pat McCormick	285-8618	Goldberg
	Ginny Mundy	unlisted	Goldberg
	Kathy Russo	872-9393	Goldberg
	Alicia Garcia	718-525-3958	Goldberg
	Gina Hayden	285-7151	Goldberg
	Carol Moore	825-1189	Goldberg
	Faye Riccardo	285-8360	Goldberg

5th Grade Rep.

825-3571	825-8197	825-1148	825-9715
568-0171	285-5129	285-1148	561-0649
825-8421	561-7170	825-1148	285-8618
285-4036	872-0498	825-1827	unlisted
825-8421	285-4986	568-0171	872-9393
285-8197	285-6267	872-0498	718-525-3958
285-5129	872-8229	825-8621	285-7151
561-7170	285-5129	568-0175	825-1189
872-0498	285-8197	285-9715	285-8360

6th Grade Rep.

825-3571	825-8197	825-1148	825-9715
568-0171	285-5129	285-1148	561-0649
825-8421	561-7170	825-1148	285-8618
285-4036	872-0498	825-1827	unlisted
825-8421	285-4986	568-0171	872-9393
285-8197	285-6267	872-0498	718-525-3958
285-5129	872-8229	825-8621	285-7151
561-7170	285-5129	568-0175	825-1189
872-0498	285-8197	285-9715	285-8360

Forest Road Parent Teacher Association 1993-1994

Positions

- Co-Presidents
- 1st Vice President
- 2nd Vice President
- 3rd Hon. Vice Pres.
- Treasurer
- Rec. Secretary
- Financial Secretary
- Corr. Secretary
- Past Pres.
- Teacher Representative

Elected Officers

- Maria Fletcher
- Laura Silverman
- Nancy Jeuda
- (Ways & Means)
- Colleen Hickey
- (Programming)
- Dr. Barbara Cronin
- Charlotte Lurie
- Robin Laurentz
- Karen Jacobson
- Ann Falley
- Susan Viggiano
- Linda Kessler

Telephone No.

- 791-3719
- 791-4928
- 791-4869
- 791-4479
- 791-6134
- 791-8662
- 791-3765
- 791-1278
- 791-8231
- 791-3705
- 791-6134

Executive Board Standing Committee Chairpersons

- Del. to Council
- Flyer Distribution
- Flyers
- Historian
- Legislation
- Safety
- Newsletter
- School Board Rep.
- Chime Rep.
- Nutrition Rep.
- 6th Gr. Yearbook
- Holiday Brunch
- Teacher Recognition
- Hospitality
- Class Mother
- Co-ordinators
- 40th Birthday Celebration
- Programming Committees
- Committee Chairperson
- Reflections
- PARP
- Family Living
- Pre-School
- Birthday Calendar
- Field Day
- Fundraising Committees
- Chairperson
- Adult Bingo
- Book Fair
- Candy Sale

- Holly Bobrow
- Bonnie Magaril
- Laura Silverman
- Robin Laurentz
- Laura Silverman
- Robin Laurentz
- Maria Fletcher
- Karen Benison
- Joyce Seelig
- 791-5191
- Maria Fletcher
- Marilyn Lefcort
- Jane Kiviat
- Ann Falley
- Ruth Klein
- Bonnie Magaril
- Cathy Hicks
- Lisa Vogel
- Charlotte Lurie
- Alison Smith
- Kathy Hicks
- Lisa Vogel
- Penny Eisenberg
- Robin Laurentz
- Carol Phillips
- Maria Fletcher
- Laura Silverman
- Alison Smith
- Susan Viggiano
- Colleen Hickey
- Alison Smith
- Susan Viggiano
- Robin Laurentz
- Ely Haber
- Eileen Hershey
- Joanne Ferraioli
- Cathy Hicks
- Mindy Ram
- Sharon Hirsh
- Ali Friedman
- Robin Laurentz
- Jill Cohen
- Alison Smith
- Sharon Hirsh
- Bonnie Magaril

- 791-5749
- 792-0201
- 791-4928
- 791-3765
- 791-4928
- 791-3765
- 791-3719
- 791-1845
- 791-5191
- 791-3719
- 791-3729
- 791-7752
- 791-8231
- 791-6226
- 792-0201
- 825-1858
- 568-1901
- 791-8662
- 791-6028
- 825-1858
- 791-8109
- 791-3765
- 791-2054
- 791-3719
- 791-4928
- 791-6028
- 791-3705
- 791-4479
- 791-6028
- 791-3705
- 791-3765
- 791-1293
- 791-7290
- 791-7232
- 825-1858
- 791-9592
- 791-5142
- 791-2651
- 791-3765
- 791-3407
- 791-6028
- 791-5142
- 792-0201

- Carnival
- Fashion Show
- Gift Wrap Sale
- Kids Bingo
- Holiday Boutique
- Plant Sale
- Pumpkin Sale
- Raffles
- Sox Hop
- Summer Book Fair
- "T" Shirt Sale

Class Parent List (*Grade Rep.)

Grade	Class Mother	Tel. Number	Teacher	Room
Kdg.	*Andrea Spector	791-1453	Scheidt	201
Kdg.	Ellen Popper	791-6276	Moskowitz	202
Kdg.	Valerie Gensheimer	791-5998		
Kdg.	*Cathy Hicks	825-1858		
Kdg.	Lynn Smolin	791-6136		
1st	Jill Cohen	791-3704	Wakely	203
1st	*Michelle Feinstein	791-9890		
1st	June Goldman	791-2666		
1st	Sherry Galvin	791-1293	Barry	204
1st	*Ely Haber	791-6502		
1st	Laura Silverman	791-4928		
2nd	Lisa Starley	872-2716	Ruschin	205
2nd	*Karen Benison	791-1845		
2nd	Lynn Fishman	791-5347		
2nd	Debbie Cohan	825-3118		
2nd	*Joanne Ferraioli	791-7232	Patterson	206
2nd	Alison Smith	791-6028		
3rd	Carol Phillips	791-2054		
3rd	*Robin Laurentz	791-3765	Guttman	207
3rd	Janet Bleler	791-4353		
3rd	Ann Tenzer	791-8857		
3rd	*Theresa Siedlick	791-1530	Maresca	209
3rd	Sheryl Weiner	791-2813		
3rd	Christine Ballot	791-8446		
4th	*Janice Brown	791-9168	Fitzgerald	210
4th	Sharon Hirsh	791-5142		
4th	*Lisa Vogel	568-1901	Stiefel	211
4th	Colleen Hickey	791-4479		
5th	*Holly Bobrow	791-5749	Lewis	212
5th	Nancy Jeuda	791-4869		
5th	*Debbie Orena	791-7951	Walsh	216
5th	Penny Eisenberg	791-8109		
5th	Shelly Salomon	791-8920		
6th	*Marlene Owen	791-7075	Lesser	217
6th	Tina Verasco	791-7198		
6th	Alicia Barreto	791-2019		
6th	*Eileen Shurgan	791-9349	Kessler	220
6th	Joan Goldfraden	791-3252		
6th	Jane Kiviat	791-7752		
LC III	*Diane Rensing	285-8504	Silverman	208
LC IV	*Elaïne Klein	791-7523	Wood	215

Shaw Avenue Parent Teacher Association 1993-1994

Elected Officers

Positions	Telephone No.
Co-Presidents	285-4162
1st Vice Pres.	285-5995
2nd Vice Pres.	825-7987
3rd Vice Pres.	825-8678
Treasurer	Faculty
Corr. Secretary	561-2357
Rec. Secretary	285-7190
Financial Secty.	872-9180
Del. to Council	285-4652
	561-3436
	561-0742
Past President	825-8462
Teacher Del.	Faculty
	Faculty

Executive Board Standing Committee Chairpersons

Adult Bowling	Joanne Cronin	825-2506
Birthday Calendar	MaryAnn Cooke	285-6890
Book Fair	Liz Shaw	825-8678
Breakfast w/Santa	PTA Executive Board	
Craft Fair	Carmelina Giacalone	285-5995
Cultural Arts	Elaine Taub	285-8273
	Carol Dolci	872-1281
Cupcake Sale	Lynne McCabe	285-4390
Dance & Twirl	Patricia Clark	285-8538
Fathers Day Boutique	Sandi Procida	825-7987
Field & Play Day	Daryl Rossello	872-2076
Fingerprinting	Nancy Barnett	872-2736
Founders Day	PTA Executive Board	
Fun Fair	PTA Executive Board	
Gift Wrap Sale	Joanne Cunningham	872-3682
Gr. Rep Coord.	Fran Buccola	561-2357
Holiday Boutique	Nancy Barnett	872-2736
Hospitality	Fran Buccola	561-2357
Installation	Ann Buffalin	561-0742
Jr. Bowling	Nancy Barnett	872-2736
Kids Bingo	Annette O'Keefe	285-4917
Legislation	Chris Shazar	825-8462
Membership	Debbie Dolan	285-7483
Moonthlight Bowl	Jackie Parise	561-3436
	Lisa Spano	285-7057
Mothers Day Sale	Fran Buccola	561-2357
Plants/Boutique	Tracy Blanchflower	285-7190
Music Comm.	Cathy Tillotson	561-2296
New Parents Tea	Elise Antonelli	872-8179
Newsletter	MaryAnn Antoniato	285-4652
Nutrition	Liz Shaw	825-8678

PAPP	MaryAnn Cooke	285-6890
Pre School	Carmelina Giacalone	285-5995
Pub. Relations	Chris Shazar	825-8462
Pumpkin Patch	MaryAnne Vanvynck	285-0530
School Barbeque	PTA Executive Board	
School Board Rep.	Chris Vessely	285-5736
School Pictures	Elaine Placente	825-3495
6th Gr. T-Shirt	Vicky Walters	872-9180
6th Gr. Yearbook	Liz Shaw	825-8678
Spring Candy Sale	PTA Executive Board	
Supermarket Bingo	Lisa Spano	285-7057
	Barbara Devivo	285-6738
T-Shirt/Sweatshirt Sale	MaryBeth Cully	825-2935
Teacher Recognition Day	Chris Shazar	825-8462
	Sandi Procida	825-7987

Class Parent List	Class Mother	Telephone No.	Teacher	Room
K Grade Rep.	MaryAnn Antoniato	285-4652	M. Glavin	101
K	Kathy Vagnone	825-3849	M. Ficarota	104
K	MaryAnn Antoniato	285-4652	J. Neary	106
K	Not Available		M. Schweigert	102
1 Grade Rep.	Tracy Blanchflower	285-7190		
1	Amy Vecchione	561-8405	P. Almafitano	110
1	Linda Phillips	285-4061	M. Fedenci	105
1	Tracy Blanchflower	285-7190	D. Ging	109
1	Lisa Delcampo	872-1332	F. Haydock	103
1	Pat Gagliano	N/A	J. Harper	112A
2 Grade Rep.	Elise Antonelli	872-8179		
2	MaryBeth Cully	825-2935	J. Ferranti	135
2	Laura Aiello	unlisted	J. Geffner	130
2	Nancy Barnett	872-2736	J. Post	133
2	Anne Buffalin	561-0742	G. Starler	131
3 Grade Rep.	Linda Phillips	285-4061		
3	Debbie Bannon	285-9873	S. Lipski	127
3	MaryAnn Cooke	285-6890	J. Lufano	132
3	Liz Shaw	825-8678	B. Melzer	128
4 Grade Rep.	Fran Buccola	N/A		
4	Michele Randazzo	285-8505	L. Benedetto	114
4	Carmelina Giacalone	285-5995	P. Garvey	119
4	Joanne Baumann	285-4987	M. Sweet	118
5 Grade Rep.	Not Available			
5	Not Available		G. Beyer	122
5	Not Available		C. Riccobono	100
5	Chris Shazar	825-8462	A. Upton	121
5	Elaine Taub	285-8273	S. Wasserman	116
6 Grade Rep.	Laura Amico	285-3196		
LC 1	Not Available		R. Decker	107A
LC 2	Angela Kowalczyk	285-8659	G. Weeks	129

SEPTA

Valley Stream Officers for 1993-1994

President:	Lori Weisblatt	285-7121	Rec. Secretary:	Franklin Stein	285-5587
Vice President:	Ronnie Swett	872-0513	Correspond. Secty.:	Phyllis O'Shea	568-0248
Vice President:	Carol Stern	791-3408	Delegates to Council:		
Hon. Vice Pres.	Dr. Martin Brooks	825-8545	V.S. Council	Karen DeVito	825-7268
Treasurer:	Diane Giordano	285-4834	SEPTA/BOCES:	Barbara Berntsen	791-3983

Valley Stream Council of PIA's Elected Officers

Co-Presidents:	Barbara Berntsen	-	791-3983	Correspond. Secty.:	Nancy Vigorito	-	285-5471
First V.Pres.	Carol Jakubowski	-	872-6306				
Scholarship:	Anne Winn	-	825-5768	Issues Chair:	Ann Marie Costiglio	-	791-1799
Second V.Pres.				Past President:	Marie Frasca	-	285-4972
Program:	Ann Marie Costiglio	-	791-1799	Past President:	June Innella	-	791-6134
Treasurer:	Rosemarie Radar	-	872-8669				
Rec. Secretary	Marie Mason	-	825-3630				



September 1993

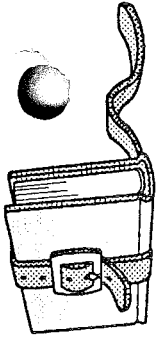

SUNDAY	MONDAY	TUESDAY	WEDNESDAY	THURSDAY	FRIDAY	SATURDAY
5 Shaded Box Indicates School is Closed	6 LABOR DAY School Closed	7 Superintendent Conference Day No Students VSCHSD Bd. of Ed. Comm. Mtg., 8 PM	8 School Opens	9 Forest PTA Exec. Bd. Mtg., 9:30 AM	10 C.S./Forest/Shaw New Parents' Tea, 9 AM	11
12	13 C.S. PTA T-Shirt & Supply Sale, 2:30 PM Shaw PTA Exec. Bd. Mtg., 7 PM & Gen. Mtg., 8 PM	14 C.S. PTA T-Shirt & Supply Sale, 2:20 PM Primary Day 5:30 AM - 9 PM Forest/Shaw C.S. PTA Class Mother's Mtg., 7:30 PM & Gen. Mtg. 8 PM VSCHSD Bd. of Ed. Mtg., 8:30 PM	15 Shaw Jr. Bowling Registration, 2:45 PM	16 Rosh Hashanah	17	18
19	20 Shaw PTA Jr. Bowling Begins Shaw Dance/Twirl Registration, 2:45 PM Dist. 30 Bd. of Ed. Comm. Mtg., 8 PM SEPTA Mtg., Memorial JHS, 8 PM	21	22	23 7:30 PM C.S./Forest/Shaw Meet the Teacher Night	24 Shaw PTA Gift Wrap Sale Begins	25 Yom Kippur
26	27 Dist. 30 Bd. of Ed. Mtg., 8 PM	28 Forest PTA Candy & Gift Wrap Sale Begins Forest PTA Mother's Mtg., 7 PM Forest PTA Gen. Mtg., 8 PM	29 Chime Mtg. Clear Stream, 8 PM	30 C. S. PTA Fingerprinting, 9-11 AM Succoth		

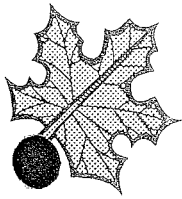

October 1993

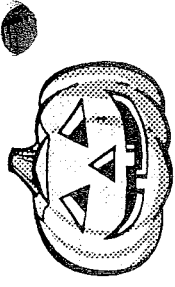

SUNDAY	MONDAY	TUESDAY	WEDNESDAY	THURSDAY	FRIDAY	SATURDAY
Shaded Box Indicates School is Closed					1 Succoth	2
3	4 C.S. PTA Reflections Starts V.S. Council of PTA's, Shaw, 8 PM	5 Forest PTA Exec. Bd. Mtg., 9:15 AM V.S. Council of PTA's, Shaw, 8 PM	6 Forest PTA Exec. Bd. Mtg., 9:15 AM V.S. Council of PTA's, Shaw, 8 PM	7 C.S. PTA Mtg., 9 AM Simchat Torah Clear Stream - Gr. 6 Outdoor Ed. Program	8 Simchat Torah	9
10	11 COLUMBUS DAY	12 Forest PTA Candy/Gift Wrap Sale Ends V.S. Council of PTA's, Shaw, 8 PM	13 Shaw PTA Gift Wrap Sale Ends Shaw - Grade 6 Outdoor Ed. Program	14 Shaw - Grade 6 Outdoor Ed. Program Clear Stream - Gr. 6 Outdoor Ed. Program	15	16
17	18 C.S. PTA Candy/Gift Wrap Sale Starts Shaw PTA Exec. Bd. Mtg., 7 PM & Gen. Mtg., 8 PM SEPTA Mtg., Mem. JHS, 8 PM Dist. 30 Bd. of Ed. Comm. Mtg., 8 PM	19 Shaw - Gr. 6 Outdoor Ed. Program Forest PTA Candy/Gift Wrap Sale Ends V.S. Council of PTA's, Shaw, 8 PM	20 C.S. PTA Pumpkin Patch Shaw PTA Fingerprinting, 9 AM Forest PTA Gen. Mtg., 8 PM	21 C.S. PTA Pumpkin Patch Shaw PTA Fingerprinting, 9 AM Forest PTA Gen. Mtg., 8 PM	22 Forest PTA Pumpkin Patch Shaw PTA Pumpkin Patch - Kindergarten	23 Forest 40th Birthday Celebration
24 Forest 40th Birthday Cele. (rain date)	25 Dist. 30 Bd. of Ed. Mtg., 8 PM	26 Forest - Gr. 6 Outdoor Ed. Program	27 C.S. Breakfast w/Superintendent, 9:30 A.M.	28	29 C.S. PTA Reflections Ends C.S. PTA Candy/Gift Wrap Sale Ends C.S. 5 & 6 Gr. PTA Halloween Party, 5-7 PM Forest 6 Gr. Halloween Party	30 Shaw PTA Fun Fair 10-3 PM
	31 Halloween					

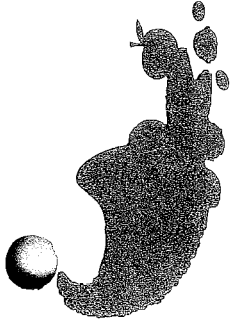

November 1993

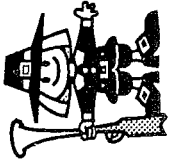

SUNDAY	MONDAY	TUESDAY	WEDNESDAY	THURSDAY	FRIDAY	SATURDAY
	1 All Saints Day	2 Superintendent's Conference Day No School for Students	3 C.S. PTA Book Fair Chime Meeting Forest, 8 PM C.S. PTA Exec. Bd. Mtg., 7 PM & Gen. Mtg. 8 PM	4 C.S./Shaw PTA Book Fairs Forest PTA Exec. Bd. Mtg., 9:15 AM C.S. PTA Supermarket Bingo, 7:30 PM	5 Forest PTA School Pictures	6
7	8 Shaw PTA School Pictures	9 Election Day Shaw/Forest 5:30 AM - 9 PM VSCHSD Bd. of Ed. Comm. Mtg. 8 P.M.	10 Forest PTA Fashion Show, 7 PM	11 VETERANS DAY School Closed	12	13
14	15 Dist. 30 Bd. of Ed. Comm. Mtg., 8 PM Shaw PTA Exec. Bd. Mtg., 7 PM & Gen. Mtg., 8 PM SEPTA Mtg., Mem. JHS, 8 PM	16 VSCHSD Bd. of Ed. Mtg., 8:30 PM	17 C.S. PTA Pre-School Mtg., 1:30 PM Forest PTA Gen. Mtg., 8 P.M.	18	19	20 Shaw PTA Kid's Bingo, 1-3 PM
21	22 Dist. 30 Bd. of Ed. Mtg., 8 PM	23 C.S. PTA School Pictures	24	25 THANKSGIVING DAY	26	27
28	29	30				

Shaded Box indicates School is Closed

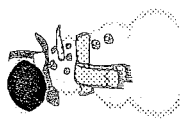

December 1993

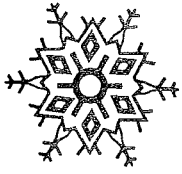

SUNDAY	MONDAY	TUESDAY	WEDNESDAY	THURSDAY	FRIDAY	SATURDAY
			1 C.S. PTA Gen. Mtg., 9 AM	2 Shaw PTA Breakfast w/ Santa Ticket Sale 2:45 PM Forest PTA Holiday Boutique	3 C.S./Forest PTA Holiday Boutiques	4 VSCHSD Building Inspection
5	6 VS Council of PTAs Wheeler, 8 PM	7 Shaw PTA Holiday Boutique	8 Immaculate Conception	9 Forest PTA Exec. Bd. Mtg., 9:15 AM Chanukah	10	11 Dist. 30 Building Inspection
12	13	14 President/Principal PTA Dinner VSCHSD Bd. of Ed. Mtg., 8:30 PM	15	16	17	18 C.S./Shaw PTA Breakfast w/Santa 9-11 AM
19	20 Dist. 30 Bd. of Ed. Mtg., 8 PM	21	22	23 Forest PTA Teacher Holiday Brunch	24 School Closed	25 Christmas Day
26	27	28	29	30	31	

January 1994

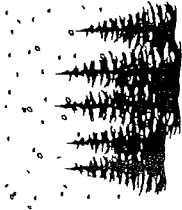

SUNDAY	MONDAY	TUESDAY	WEDNESDAY	THURSDAY	FRIDAY	SATURDAY
<p>Shaded Box Indicates School is Closed</p>						1 New Years Day
2	3 Schools Open	4	5	6 Forest PTA Exec. Bd. Mtg., 9:15 AM	7	8
9	10 Shaw PTA Exec. Bd. Mtg., 7 PM & Gen. Mtg., 8 PM SEPTA Mtg., Mem. JHS, 8 PM	11 VSCHSD Bd. of Ed. Comm. Mtg., 8 PM	12 CHIME Meeting, Shaw, 8 PM	13 C.S. PTA Exec. Bd. Mtg., 7 PM & Gen. Mtg., 8 PM	14	15 Forest PTA Kids' Bingo, 1-3 PM
16	17 Martin Luther King Day	18 VSCHSD Bd. of Ed. Mtg., 8:30 PM	19 Shaw Breakfast w/Superintendent, 9:30 AM	20 C.S. PTA Cupcake Sale, 2:15 PM	21	22
23	24 Dist. 30 Bd. of Ed. Mtg., 8 PM	25	26 Forest PTA PARP Begins	27 Forest PTA Book Fair	28	29 Forest PTA Book Fair
						Shaw PTA Moonlight Bowl, 8 PM



February 1994

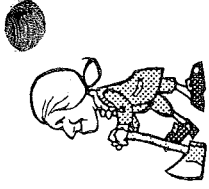

MONDAY	TUESDAY	WEDNESDAY	THURSDAY	FRIDAY	SATURDAY
	1 Shaw PTA Spring Candy Sale Begins Shaw PTA Pre-School Mtg., 2:45 PM VSCHSD Bd. of Ed. Comm. Mtg., 8 PM	2	3 C.S. PTA Gen. Mtg., 9 AM Forest PTA Exec. Bd. Mtg., 9:15 AM	4	5 VSCHSD Bd. of Ed. Budget Review
6	7	8 PTA Day in Albany	9	10	11 Forest PTA PARRP Ends
	VS Council of PTAs Carbonaro, 8 PM	15 VSCHSD Bd. of Ed., Mtg., 8:30 PM	16 PTA Founders Day, at Shaw, 7:30 PM Ash Wednesday	17	18 Forest PTA Sox Hop, 7:30 PM
13	14 Shaw PTA Spring Candy Sale Ends SEPTA Mtg., Mem. JHS, 8 PM	15	22 Washington's Birthday	23	19
20	21	22 Winter Recess	23	24	25 Purim
27	28 C.S./Shaw PARRP Begins Dist. 30 Bd. of Ed. Mtg., 8 PM				26
					12 Lincoln's Birthday
					19 C.S. PTA Valentine's Dance, 8 PM

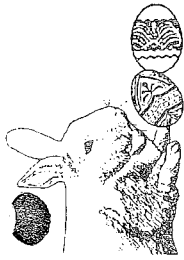

April 1994

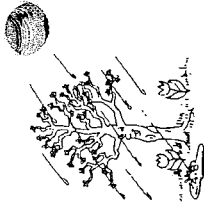

SUNDAY	MONDAY	TUESDAY	WEDNESDAY	THURSDAY	FRIDAY	SATURDAY
Shaded Box Indicates School is Closed					1	2
3 Last Day of Passover	4	5 Shaw PTA PARP Ends	6 VSCHSD Bd. of Ed. Comm. Mtg., 8 PM	7 C.S. PTA Mtg., 9 AM Forest PTA Exec. Bd. Mtg., 9:15 AM	8	9
Easter Sunday						
10	11 Shaw PTA Exec. Bd. Mtg., 7 PM & Gen. Mtg., 8PM VS Council of PTAs Clear Stream, 8 PM	12 VSCHSD & Dist. 13 Budget Hearings Dever, 8 PM	13 VSCHSD & Dist. 30 Budget Hearings Shaw, 8 PM	14 VSCHSD & Dist. 24 Budget Hearings Buck, 8:15 PM	15 Shaw PTA Spring Cupcake Sale	16
17	18 Dist. 30 Bd. of Ed. Comm. Mtg., 8 PM SEPTA Mtg., Mem. JHS, 8 PM	19 C.S. Teacher Recognition Forest PTA Gen. Mtg., 8 PM VSCHSD Bd. of Ed. Mtg., 8:30 PM	20	21 Forest Pre-School Mtg., 3 PM	22	23
24	25 Dist. 30 Bd. of Ed. Mtg., 8 PM	26	27 7-9 AM & 4-9 PM All Schools Budget Vote Registration Forest PTA Adult Bingo Mtg., 8 PM	28	29 Kindergarten Registration All Schools 9 - 11 AM C.S. PTA Kid's Night Out, 7 PM	30

May 1994

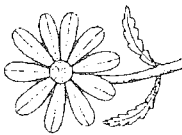
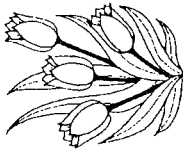

SUNDAY	MONDAY	TUESDAY	WEDNESDAY	THURSDAY	FRIDAY	SATURDAY
1	2	3	4	5	6	7
		VSCHSD Bd. of Ed. Annual Mtg., 7:30 PM & Comm. Mtg., 8 PM	School Budget Vote All Schools, 7 AM - 10 PM District Art Exhibit Forest Plant Pre-Order Pick-Up	Forest PTA Plant Sale	C.S./Forest PTA Plant Sale Shaw PTA Mother's Day Boutique/Plant Sale	Shaw PTA Craft Fair 10 AM - 3 PM
8	9	10	11	12	13	14
Mother's Day			C.S. PTA Exec. Bd. Mtg., 7 PM & Gen. Mtg., 8 PM	Forest PTA Exec. Bd. Mtg., 9:15 AM Ascension Thursday		
15	16	17	18	19	20	21
	Shaw PTA Exec. Bd. Mtg., 7 PM & Gen. Mtg., 8 PM	VSCHSD Bd. of Ed. Mtg., 8:30 PM		Shaw Teacher Recognition, 11 - 2 PM Forest Pre-School Mtg., 3 PM	Shaw PTA Installation Dinner, 7:30 PM	
22	23	24	25	26	27	28
	Shavuot		CHIME Meeting Forest, 8 PM		District 30 Retirement Dinner	
	Dist. 30 Bd. of Ed. Comm. Mtg., 8 PM		Forest PTA Installation Dinner, 7:30 PM			
29	30	31				
	Memorial Day					Shaded Box Indicates School is Closed

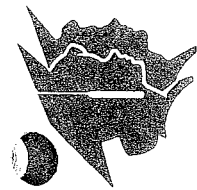

June 1994

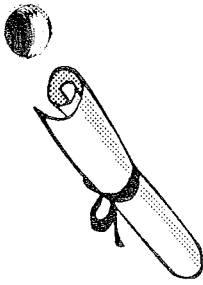

SUNDAY	MONDAY	TUESDAY	WEDNESDAY	THURSDAY	FRIDAY	SATURDAY
Shaded Box Indicates School is Closed			1	2 C.S. PTA Gen. Mtg., 9 AM Forest Exec. Bd. Mtg., 9:15 AM	3	4
5	6 VS Council of PTAs, South High, 8 PM	7 Field Day Shaw	8 Field Day Shaw (rain date)	9 Forest PTA Teacher Recognition Day	10	11
12	13 Field Day Forest VS Council of PTAs, South High, 8 PM Shaw PTA Exec. Bd. Mtg., 7 PM & Gen. Mtg., 8 PM SEPTA Mtg., Mem. JHS, 8 PM	14 Field Day Forest (rain date) Flag Day VSCHSD Bd. of Ed. Mtg., 8:30 PM	15 C.S. PTA Father's Day Boutique	16 Shaw PTA Father's Day Boutique	17	18 Forest PTA Book Fair
19 Father's Day	20 Father's Day	21 VSCHSD Bd. of Ed. Mtg., 8:30 PM	22 C.S./Forest/Shaw 6th Grade Closing Exercises 8:15 PM	23 Kindergarten Graduation, 9:30 AM All Schools Shaw PTA School-wide Barbecue Forest Gr. 6 Moving Up Party, 1 - 3 PM	24 Last Day of School	25
26	27 Dist. 30 Bd. of Ed. Comm. Mtg., 8 PM Dist. 30 Bd. of Ed. Mtg., 8 PM	28	29	30		

July 1994

SUNDAY	MONDAY	TUESDAY	WEDNESDAY	THURSDAY	FRIDAY	SATURDAY
					1	2
3	4 Independence Day	5	6	7	8	9
10	11	12	13	14	15	16
17	18	19 COUNSEL BUILDS Respect from 7:30 PM	20	21	22	23
24	25	26	27	28	29	30
	31					

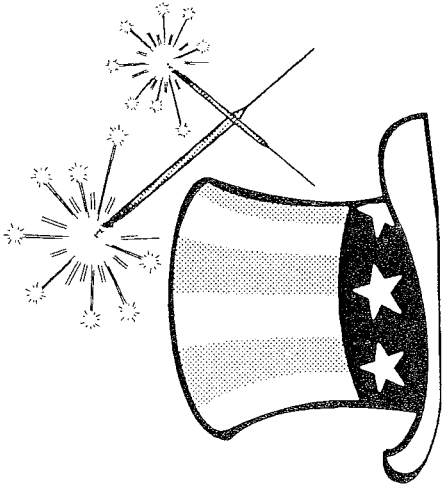

August 1994

SUNDAY	MONDAY	TUESDAY	WEDNESDAY	THURSDAY	FRIDAY	SATURDAY
	1	2	3	4	5	6
7	8	9	10	11	12	13
14	15 Assumption	16	17	18	19	20
21	22	23	24	25	26	27
28	29	30	31			

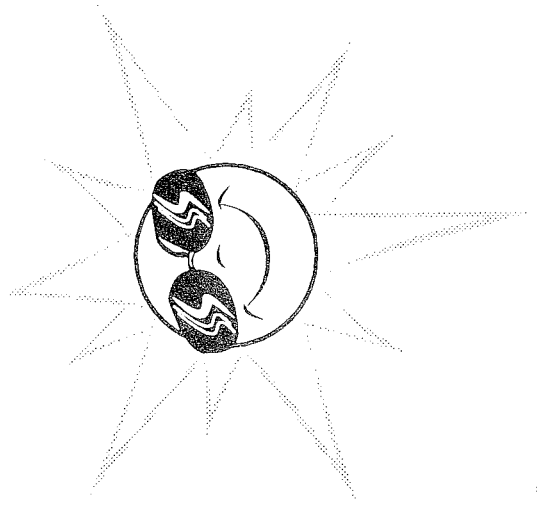

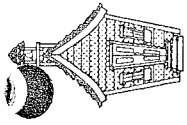

September 1994

(Tentative)

ABC

SUNDAY	MONDAY	TUESDAY	WEDNESDAY	THURSDAY	FRIDAY	SATURDAY
				1	2	3
4	5 Labor Day	6	7 Rosh Hashanah	8 Superintendent's Conference Day No School for Students	9 School Opens (Tentative)	10
11	12	13	14	15	16	17
18	19	20	21	22	23	24
25	26	27	28	29	30	

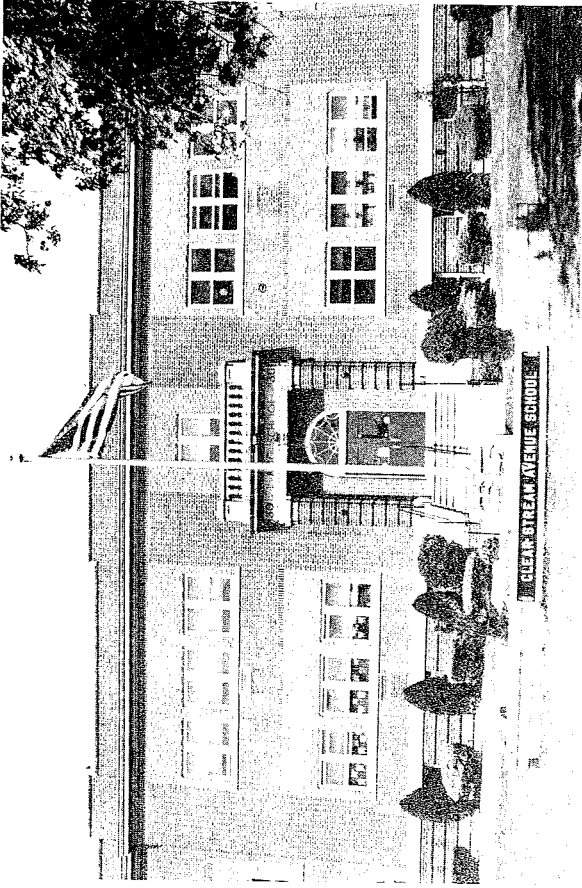

Clear Stream Avenue School
Clear Stream Ave., Valley Stream, NY 11582

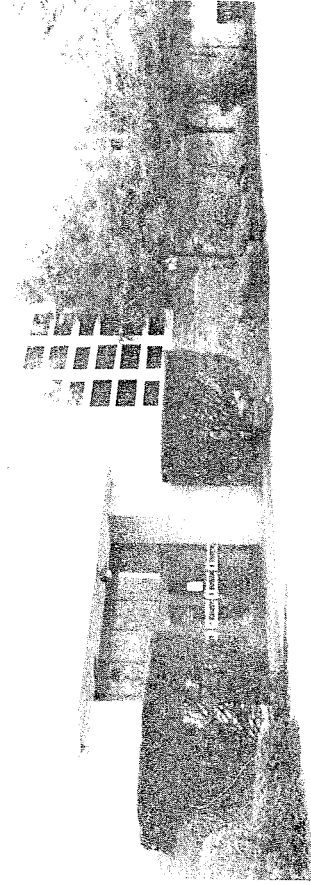

Shaw Avenue School
Shaw Ave., Valley Stream, NY 11582

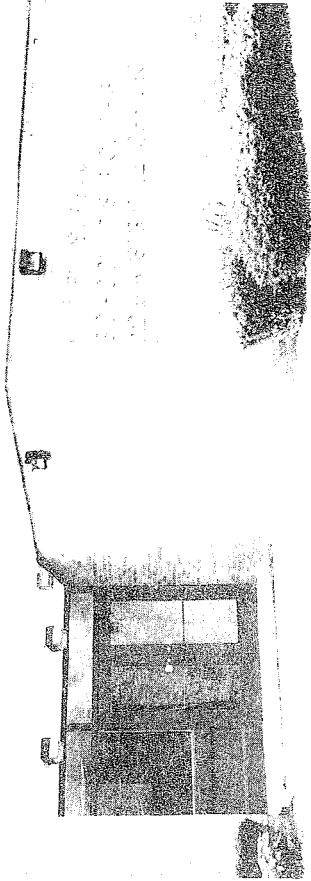

Valley Stream School District Thirty Administrative Offices
150 Washington Ave., Valley Stream, NY 11582

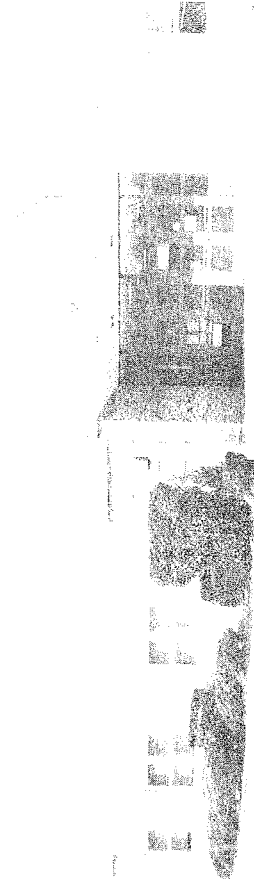

Forest Road School
16 Forest Rd., Valley Stream, NY 11582



Valley Stream District 30

Calendar of Events
1996 - 1997

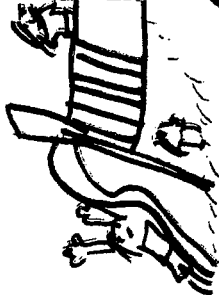
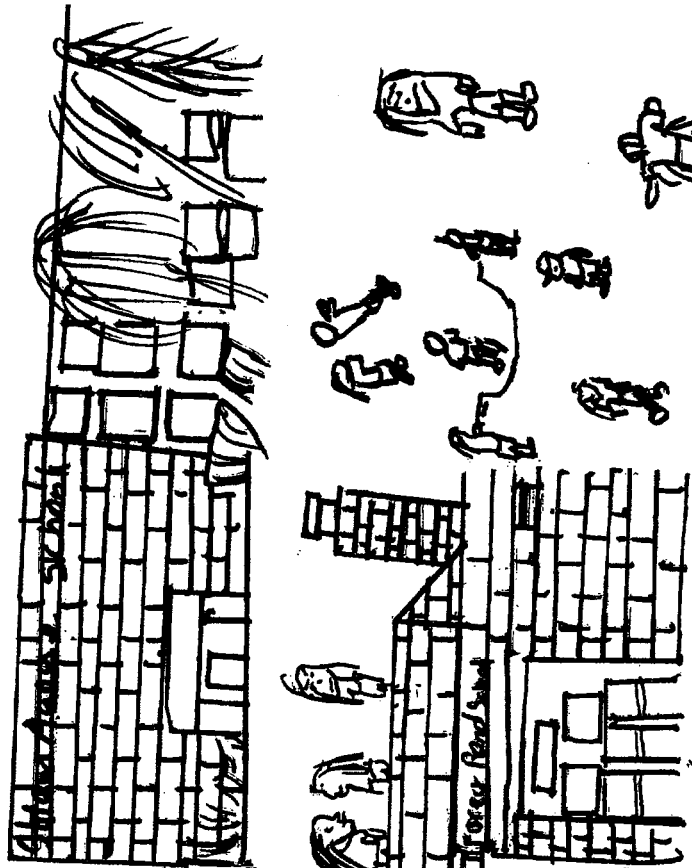
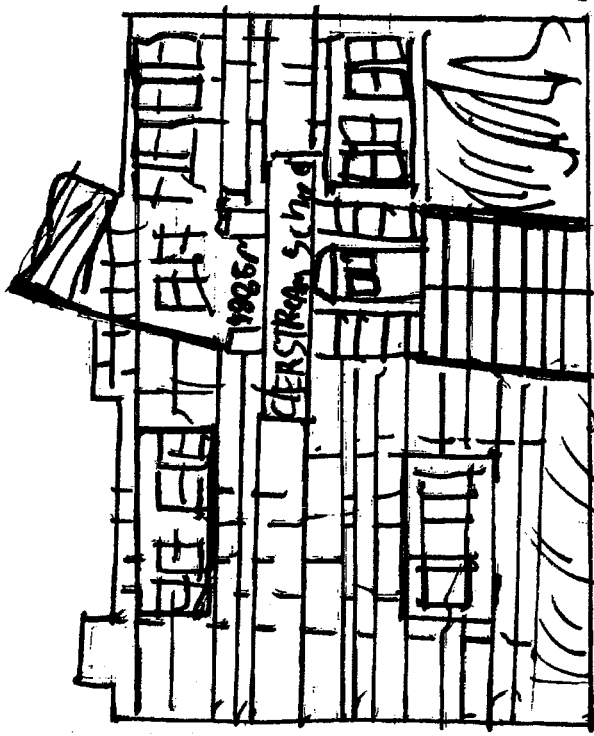
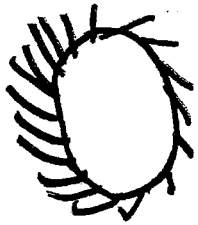

Published by the Board of Education and the Parent Teacher Associations

Board of Education



Standing (left to right): *Andrew Walters, President; Leanoire Egan, Vice President; Thomas Galgano, Trustee;
Seated (left to right): *William Gauger, Trustee; Lawrence R. McGoldrick, Superintendent of Schools;
*Richard Eisenberg, Trustee

*Also serves on the High School Board

School Telephone Directory

Main Office: Washington Avenue School

Superintendent 285-9881
 Business Office 285-9880
 Curriculum Office 285-9833
 FAX 285-9839

Clear Stream Avenue School

Principal's Office 872-4333
 Nurse's Office 872-4336

Forest Road School

Principal's Office 791-6134
 Nurse's Office 791-6790

Shaw Avenue School

Principal's Office 872-4320
 Nurse's Office 872-4327

Special Services

Computer Coordinator/AV Consultant 872-4342
 Committee for Special Education,
 Chairperson 285-9820
 Sp. Ed. Parent Reps. Mrs. Lefcort 791-3729
 Mrs. Scuderi 872-8144
 Mrs. Vardakis 791-7285

Index

Board of Education Page 2
 District Staff Page 4
 Special Services and Programs Page 5
 General Information Page 6
 Weather Closings Page 6
 School Policies Pages 7 & 8
 Clear Stream PTA & Class Parent Page 9
 Forest Road PTA & Class Parent Page 10
 Shaw Avenue PTA & Class Parent Page 11
 Monthly Calendars Pages 12 - 23
 Valley Stream Council of PTA's & SEPTA Page 22

Valley Stream High School District

Central High School 561-4400
 Memorial Junior High School 872-7700
 North High School 564-5500
 South High School 791-0300

Valley Stream School District No. 30 and Valley Stream Central High School District Valley Stream, New York

District No. 30 Schools

Shaw Avenue A
 Clear Stream Avenue B
 Forest Road C
 Washington Avenue D
 (District Office)

High Schools

North High 1
 Memorial Jr. High 2
 Central High 3
 South High 4

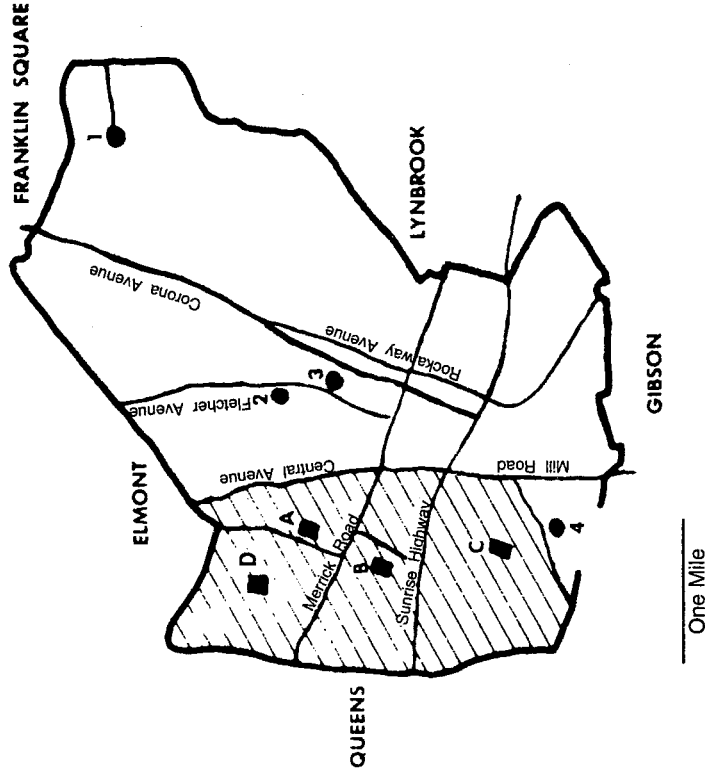

Calendar Preparation:

Dr. Barbara Warren Cronin
 Angela Nicolini

Cover Design:

Robert Ruvinsky, Grade 3, Forest Road School

School Administration

Dr. Charles W. Fowler, District Superintendent

Lawrence R. McGoldrick
Superintendent of Schools

David Kutcher
Assistant Superintendent

Gene Nyitray
Director of Special Services & Programs

School Principals

Clear Stream Avenue School
Mr. Robert A. Cohen

Forest Road School
Dr. Barbara Warren Cronin

Shaw Avenue
Mr. Stanley Kaminsky

Director of Facilities
Gregory Abbate

Secretary to Superintendent
Madelaine Furst

School Secretaries

Lane Griffin, Clear Stream Avenue
Angela Nicolini, Forest Road
Anne Docar, Shaw Avenue

Secretarial Staff

Marilyn Berkowitz
Carol Blankshine
Elaine Faling
Lillian Grazian
Mabel Horn
Grace Pisano
Marilyn Russo
Anne O'Brien

Building Level Teams

Clear Stream Avenue School

Mr. Robert A. Cohen
Sandra Aragona
Carol Belmonte
Karen Catalanotto
Barbara Clarke
Faye Marino
Julie McCain
Mary Sheffield
Joanne Spano
Mary Anne Swanson

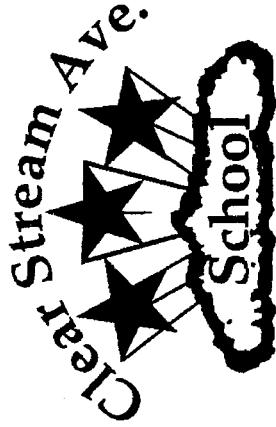

Forest Road School

Dr. Barbara Warren Cronin
Arlene Drimal
Bonnie Epstein
Eilyn Fitzgerald
Maria Fletcher
Elaine Friedman
Jill Mandel
Allison Needleman
Dennis Terrell
Carol Tolle

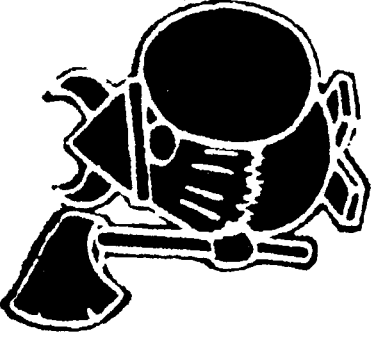

Shaw Avenue School

Mr. Stanley Kaminsky
Elise Antonelli
Lois Benedetto
Joan Franzese
Ann Marie Homer
Joanne Lufrano
Philip Mandzik
Judy Neary
Elizabeth Shaw

Special Services and Programs

It is the commitment of District Thirty to provide challenging and successful educational experiences for all children. Such challenges and successes will differ from child to child. The Office of Special Services and Programs is responsible for coordinating the various district-wide activities which promote school success for every child. Included in these activities are standardized testing, reading remediation, English as a Second Language, Gifted and Talented Education, speech and language therapy, health screening, counseling, and special education services.

Through the committee on Special Education (CSE) and the Committee on Pre-School Special Education (CPSE) children are assessed to determine eligibility for special education services. If a school-aged child is determined to have a disability, appropriate services will be provided within the consideration of the least restrictive environment. Appropriate services and instruction are determined by CSE/CPSE review and incorporated in the student's Individualized Education Program (IEP). Within District Thirty, students may receive IEP related services such as speech and language therapy, resource room, counseling, and occupational/physical therapy while participating in the regular education program. Learning Center (LC) classes provide instruction in reduced size learning environments with opportunities to be mainstreamed (as appropriate) into regular education classes. Some children because of their unique needs may benefit from out-of-district classes in neighboring school districts, BOCES programs, or private school placements. In any case, successfully meeting the needs of each child with a disability is the result of meaningful collaboration among parents, teachers, related services staff, administrators, and the CSE.

For preschool children between three and five years of age, the Committee on Pre-School Special Education (CPSE) process is designed to identify children who may be in need of special education services. Parents who suspect that their preschool child may not be attaining age-expected developmental behaviors are encouraged to contact the Director of Special Services for information about CPSE and the types of services available to eligible children. The Office of Special Services and Programs also coordinates with the Early Intervention Program of the Nassau County Department of Health to provide a smooth transition of services for infants and toddlers with disabilities to CPSE.

District Thirty also provides services to eligible children as specified by Section 504 of the Rehabilitation Act of 1973. The Director of Special Services and Programs is also the Section 504 Coordinator for the district.

The Office of Special Services and Programs is located at Washington Avenue Administrative Building; the phone number is 285-9833.

Elaine Faling
CSE/CPSE Secretary

Gene Nyitray
Director

Lillian Grazian
Secretary

Vandalism

Vandalism costs money. Help us to reduce this drain on our tax dollars by keeping a watchful eye on your local school. Perhaps you have noticed persons on school grounds who were behaving suspiciously or actually engaged in vandalism, but you have not known where to call.

To report school vandalism or suspicious activities at your school, call the Nassau County Emergency Number 911. Give the name of the school, its location, and a brief description of what is happening. A police car will be radio-dispatched to investigate, and appropriate school personnel will be alerted. School officials will prosecute offenders whenever possible and attempt to secure restitution for damages.

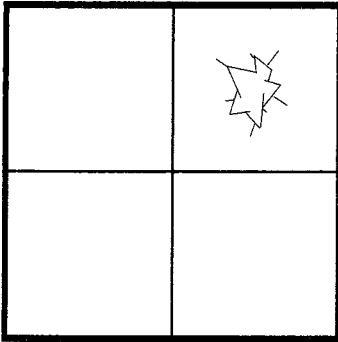

Please report any of these activities:

- persons on the roof of the school
- anyone throwing objects at windows
- someone shooting weapons of any kind
- any kind of fire on school grounds
- destruction of grounds, shrubbery, or facility
- anyone operating mini-bikes on playgrounds or driveway
- any other suspicious or criminal acts

Use of School Facilities

The Board of Education encourages the use of school facilities for community purposes when such use does not interfere with the scheduled school program. Organizations desiring to use school facilities should request an "Application for the Use of School Facilities" form from the principal of the school involved. Administrative rules and a statement of costs are explained on the application form.

School Visits

Parents are encouraged to visit school to meet the members of the professional staff, to examine the facilities, and instructional programs, and to share ideas. Those wishing to observe classes or to meet with staff members should arrange the visit in advance so that the time is appropriate and does not interfere with planned activities.

All visitors must register at the school office upon arrival, before visiting other parts of the building.

At dismissal times, parents picking up students are requested to meet them at a previously designated spot outside of the school. Dismissal exits have been assigned to classes in each building. Students are expected to leave the school building and school property in an orderly fashion at dismissal time each day. Such procedures are necessary to insure the safety of all students.

School Closings or Delayed Openings

Weather and other emergencies may warrant school closings or delayed openings. A delayed opening means students are expected to be at school at 10 AM. PTA Class Parents will be informed and will initiate telephone calls to inform parents in each class. NEWS 12 on Channel 12 will carry school closing information. Such school closings or delays will be also announced on the following local radio stations:

WCBS (AM)	88	WHLI (AM)	1100
WGBB (AM)	1240	WINS (AM)	1010
WGSM (AM)	740	WALK (FM)	97.5
		WALK (AM)	1370

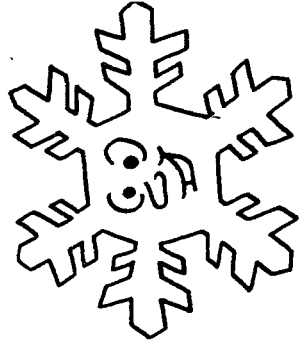

School Policies

School Hours for all Schools

Kindergarten to Grade 6, including Special Classes: 8:30 a.m. to 2:45 p.m. First bell rings at 8:20 a.m. Check with your school regarding availability of supervision for students who arrive before 8:20 a.m.

Breakfast

Students participating in the District Breakfast Program should not arrive before 7:50 a.m. **Supervision is not provided for students prior to that time.**

Lunch

Lunch is served beginning on the first day of school. Pupils may go home for lunch, bring lunch from home, or buy the school lunch in the cafeteria. **Students are not permitted to leave school for lunch unless picked up by a parent or authorized adult.** Monthly menus are provided. In case a child forgets or loses his/her lunch money, there is a charge system to cover the emergency. The secretary keeps the record of such charges and contacts the parents should a charge not be paid in a reasonable time. Students may purchase prepaid lunch tickets. Each ticket provides 20 meals, and is valid until June, or until all 20 meals are used. All tickets will remain with the Cafeteria Cashier.

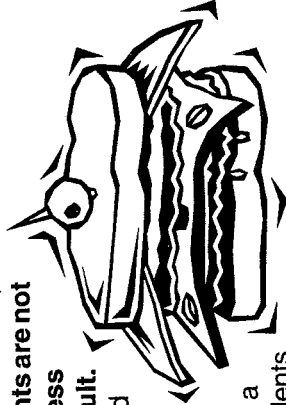

Snack Milk & Juice

Snack milk & juice are sold to all children beginning the first day of school. You will be notified as to exact date for payment. In case of a child's absence, no refund is made for period of less than a full week.

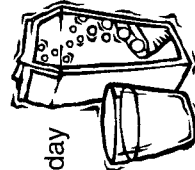

Absences

When your child has been absent, State law requires that he/she bring a note from you explaining the absences and the date(s) of absence(s). The note should be presented to the nurse **before** he/she goes to the classroom. Please be specific. Just saying, "he/she was ill", is not enough. Indicate whether it was "virus", "fever", "cold", etc.

A note is required for an absence due to a religious holiday. A note is required for any tardiness, giving the reason. If your child contacts a contagious disease,

such as mumps, measles, etc., please phone the school nurse so that she can alert the parents in your child's class that their children have been exposed. Be sure to keep the emergency card up to date so that we will know whom to call should your child become ill and have to go home.

Noon Hour Rules

Students who repeatedly misbehave in the cafeteria, auditorium, or on the playground during the noon hour, may be excluded from staying in school for lunch for a few days. If you receive such a note from the principal/teacher, we would appreciate your cooperation. Whether or not a parent is home during the noon hour has no bearing on this exclusion.

Exits and Entrances

Your child's class is assigned a specific exit and entrance to use. You will thus know where to meet him/her when you come to pick up. Parents picking up children are asked to meet them at the exit, **not the classroom.** Parents must wait outside the school at dismissal time.

Class Interruptions

No unnecessary interruptions of classes are allowed once the day's sessions have begun. When your child forgets a book, homework, sneakers, lunch money, etc., please bring these to the office. All pupils are instructed to check with the office at lunch time for such forgotten items. In the interest of the child's all-round education, we urge you not to make a practice of bringing forgotten items to school. The child should be developing his/her own sense of responsibility for these things.

Physical Education Attire and Sneakers

Boys and girls are required to wear appropriate attire and sneakers on assigned gym days. **NO ONE IS ALLOWED ON THE GYM FLOOR WITHOUT SNEAKERS.**

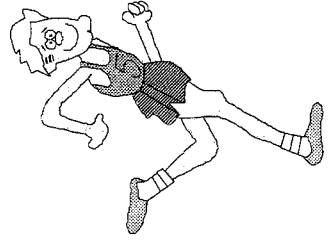

School Policies

Appointments with Teachers

In order that pupils' class time be used to the fullest advantage, we request that parents do not seek conferences with teachers during school hours. If you wish a conference, please make an appointment to see the teacher after school. Teachers are available for such conferences every day except Wednesdays and Fridays.

Bicycles

NO bicycles are allowed at either Forest Road or Clear Stream Avenue Schools because no child lives far enough from the school to make them necessary. They are allowed at Shaw, but are restricted to pupils in grades 4, 5, and 6 who live NORTH OF FOSTER AVENUE. **Bicycle operators must wear safety helmets.** All must have a lock and chain for safety purposes.

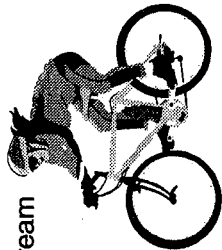

Gifts to Teachers Prohibited

The policy of the school district which became effective January 1956, is to prohibit the acceptance of gifts by faculty members on school premises, and to prohibit the solicitation of funds for personal gifts purposes, by any person, or persons, on the premises.

In-Day Program

In inclement weather, there is an in-day program of motion pictures or quiet games provided for those pupils who eat in the cafeteria. Pupils who go home to lunch are not allowed to participate in this program because of space limitations, so we ask parents to return these pupils to school on such days just in time for the afternoon session - not before five minutes prior to their scheduled lunch time.

Homework Requirements

Classroom learning is improved through effective homework assignments. Homework may include review, reinforcement, reading in preparation for classroom discussion, analysis and research. Homework helps students establish



work habits which will influence their use of time throughout life. Homework is required of all pupils, but it will vary from day to day. First and second grade pupils may have fifteen to twenty minutes of homework per day, while third and fourth grade pupils are likely to have thirty to forty minutes. Fifth and sixth graders are expected to devote as much as an hour to homework.

Students should require little if any help from parents in completing assignments. However, parents may assist students by insuring that they have a quiet, comfortable place to work.

Lost and Found

Unmarked articles lost by pupils are placed in the Lost-and-Found, which is in the Nurse's Office at Clear Stream, Shaw and Forest. Such articles, if not claimed at the end of the school year, are given to a charitable organization. However, any article bearing a child's name is returned directly to him/her. Please place your child's name on all his/her belongings.

Assemblies

When your child's class puts on an assembly program, we welcome your attendance, but we do ask you not to bring pre-school children. As much as we realize that it is a thrill for them to see older siblings perform, they are often distracting to all concerned. Picture taking or video taping are not allowed without prior approval.

Medication

When it is necessary for the child to take internal medication during school hours, the nurse will cooperate with the family physician and the parents. The parent must submit a written request to the Nurse with a written request from the family physician indicating the frequency and dosage of a prescribed medication. Then the school nurse will administer this medication during the school hours. Under no circumstances will a child be permitted to carry or to take medication by himself or herself.

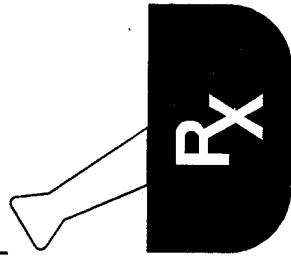

CLEAR STREAM AVENUE PARENT TEACHER ASSOCIATION 1996-1997

- ELECTED OFFICERS**
 Cathy Montefusco
 Mary Sheffield
 Joanne Spano
 Carole Belmonte
 Sara Makarewicz
 Robert A. Cohen
 Rosemary Miller
 Della Doyno
 Pat Raykowski
 Peggy Riccio
 Rosann DiPalma
 Lisa Rostrom
 Karen Catalanotto
 Sandra Aragone
 Valerie Campolo
 Valerie Tee
 Sally Kaplan
 Terry Lusenkas
 Pat McCormick
 Sally Kaplan
 Penny Preziotte
 Della Doyno
 JoAnna Ortiz
 Rosann DiPalma
 Mary MacLean
 Pat Raykowski
 Aurelia Martinec
 Grace Porti
 Alice Swahn
 Rosemary Miller
 Donna LaBarbera
 Toni Steenbeck
 Executive Board
 Executive Board
 Toni Steenbeck
 Pat McCormick
 Valerie Campolo
 Carol Belmonte
 Rosann DiPalma
 Terri Lusenkas
- TELEPHONE**
 561-7170
 285-6221
 285-6690
 285-6257
 568-0171
 872-4333
 872-3224
 825-3571
 285-5675
 285-8140
 285-4036
 561-8798
 Faculty
 Faculty
 285-6345
 825-3052
 872-0557
 285-8618
 825-3052
 285-8313
 825-3571
 285-1567
 285-4036
 Faculty
 285-5675
 285-3523
 872-9627
 872-9627
 285-5485
 872-3224
 285-0903
 285-5843
 285-5843
 285-8618
 285-6345
 285-6267
 285-4036
 872-0557
- POSITION**
 Co-President
 Co-President
 1st VP - Program
 2nd VP - Pre-school
 3rd VP - Ways & Means
 Hon. V.P.
 Treasurer
 Membership
 Recording Secretary
 Corresponding Secretary
 Delegates to Council
- TEACHER**
 Fran Lozano
 Toni Steenbeck
 Marie Bernero
 Barbara Schehr
 Grace Porti
 Pat Raykowski
 Della Doyno
 Maryann Lanz
- TEACHER**
 Golfo
 Golfo
 Golfo
 Libertini
 Libertini
 Libertini
 Sacks
 Sacks
 Sacks
 Epstein
 Epstein
 Epstein
 Franklin
 Franklin
 Franklin
 Ventura
 Ventura
 Aragone
 Aragone
 Aragone
 Lopez
 Lopez
 Lopez
 Murray
 Murray
 Murray
 Cabral
 Cabral
 Cabral
 Ehrenreich
 Ehrenreich
 Ehrenreich
 MacLean
 MacLean
 Clarke
 Clarke
 Clarke
 Speiss
 Speiss
 Speiss
 Catalanotto
 Catalanotto
 Catalanotto
 Yelland
 Yelland
 Yelland
 Cooper
 Cooper
 Cooper
 Cooper
 Dunn
 Dunn
 Dunn
 Dunn
 McCain
 McCain
 McCain
 McCain
- TEACHER**
 Fran Lozano
 Toni Steenbeck
 Marie Bernero
 Barbara Schehr
 Grace Porti
 Pat Raykowski
 Della Doyno
 Maryann Lanz
- TEACHER**
 Golfo
 Golfo
 Golfo
 Libertini
 Libertini
 Libertini
 Sacks
 Sacks
 Sacks
 Epstein
 Epstein
 Epstein
 Franklin
 Franklin
 Franklin
 Ventura
 Ventura
 Aragone
 Aragone
 Aragone
 Lopez
 Lopez
 Lopez
 Murray
 Murray
 Murray
 Cabral
 Cabral
 Cabral
 Ehrenreich
 Ehrenreich
 Ehrenreich
 MacLean
 MacLean
 Clarke
 Clarke
 Clarke
 Speiss
 Speiss
 Speiss
 Catalanotto
 Catalanotto
 Catalanotto
 Yelland
 Yelland
 Yelland
 Cooper
 Cooper
 Cooper
 Cooper
 Dunn
 Dunn
 Dunn
 Dunn
 McCain
 McCain
 McCain
 McCain

- TELEPHONE**
 561-7170
 285-6221
 285-6690
 285-6257
 568-0171
 872-4333
 872-3224
 825-3571
 285-5675
 285-8140
 285-4036
 561-8798
 Faculty
 Faculty
 285-6345
 825-3052
 872-0557
 285-8618
 825-3052
 285-8313
 825-3571
 285-1567
 285-4036
 Faculty
 285-5675
 285-3523
 872-9627
 872-9627
 285-5485
 872-3224
 285-0903
 285-5843
 285-5843
 285-8618
 285-6345
 285-6267
 285-4036
 872-0557
- TEACHER**
 Fran Lozano
 Toni Steenbeck
 Marie Bernero
 Barbara Schehr
 Grace Porti
 Pat Raykowski
 Della Doyno
 Maryann Lanz
- TEACHER**
 Golfo
 Golfo
 Golfo
 Libertini
 Libertini
 Libertini
 Sacks
 Sacks
 Sacks
 Epstein
 Epstein
 Epstein
 Franklin
 Franklin
 Franklin
 Ventura
 Ventura
 Aragone
 Aragone
 Aragone
 Lopez
 Lopez
 Lopez
 Murray
 Murray
 Murray
 Cabral
 Cabral
 Cabral
 Ehrenreich
 Ehrenreich
 Ehrenreich
 MacLean
 MacLean
 Clarke
 Clarke
 Clarke
 Speiss
 Speiss
 Speiss
 Catalanotto
 Catalanotto
 Catalanotto
 Yelland
 Yelland
 Yelland
 Cooper
 Cooper
 Cooper
 Cooper
 Dunn
 Dunn
 Dunn
 Dunn
 McCain
 McCain
 McCain
 McCain

- TELEPHONE**
 561-7170
 285-6221
 285-6690
 285-6257
 568-0171
 872-4333
 872-3224
 825-3571
 285-5675
 285-8140
 285-4036
 561-8798
 Faculty
 Faculty
 285-6345
 825-3052
 872-0557
 285-8618
 825-3052
 285-8313
 825-3571
 285-1567
 285-4036
 Faculty
 285-5675
 285-3523
 872-9627
 872-9627
 285-5485
 872-3224
 285-0903
 285-5843
 285-5843
 285-8618
 285-6345
 285-6267
 285-4036
 872-0557
- TEACHER**
 Fran Lozano
 Toni Steenbeck
 Marie Bernero
 Barbara Schehr
 Grace Porti
 Pat Raykowski
 Della Doyno
 Maryann Lanz
- TEACHER**
 Golfo
 Golfo
 Golfo
 Libertini
 Libertini
 Libertini
 Sacks
 Sacks
 Sacks
 Epstein
 Epstein
 Epstein
 Franklin
 Franklin
 Franklin
 Ventura
 Ventura
 Aragone
 Aragone
 Aragone
 Lopez
 Lopez
 Lopez
 Murray
 Murray
 Murray
 Cabral
 Cabral
 Cabral
 Ehrenreich
 Ehrenreich
 Ehrenreich
 MacLean
 MacLean
 Clarke
 Clarke
 Clarke
 Speiss
 Speiss
 Speiss
 Catalanotto
 Catalanotto
 Catalanotto
 Yelland
 Yelland
 Yelland
 Cooper
 Cooper
 Cooper
 Cooper
 Dunn
 Dunn
 Dunn
 Dunn
 McCain
 McCain
 McCain
 McCain

FOREST ROAD PARENT TEACHER ASSOCIATION
1996-1997
TELEPHONE NO.

ELECTED OFFICERS
 Alison Smith 791-6028
 Jill Cohen 791-3407
 Sharon Hirsh 791-5142
 Ways & Means
 Ruth Klein 791-6226
 Programming
 Dr. Barbara Warren Cronin 791-6134
 Karen McDaniel 791-4574
 Arlene Drimal 791-5268
 Lisa Vogel 568-1901
 Mindy Ram 791-9592
 Linda Silverman 791-4928
 Linda Kessler 791-6134

EXECUTIVE BOARD COMMITTEE CHAIRPERSONS

Lisa Vogel 568-1901
 Helene Harris 791-8425
 Anne Falley 791-6231
 Charlotte Lurie 791-8662
 Ruth Klein 791-6226
 Susan Viggiano 791-3705
 Carol Slipman 791-3808
 Maria Shea 791-1606
 Lisa Vogel 568-1901
 Altigracia Concha 791-6148
 Cathy Hicks 825-1858
 Lisa Vogel 568-1901
 Meryl Leshansky 791-8425
 Helene Harris 791-8425
 Laura Silverman 791-4928
 Dorothy Mancini 791-5794
 Ruth Klein 791-6226
 Anne Falley 791-3719
 Maria Fletcher 791-6231
 Laura Silverman 791-4928
 Ellen Popper 791-6276
 Gail Schiffer 791-5080
 Ileana Ossosky 568-0403
 Laura Silverman 791-4928
 Wendie Ciorciari 791-4266
 Lynn Smolin 791-6136
 Susan Aviza 374-6846
 Joy Ramdhaney 825-1858
 Cathy Hicks 568-1901
 Lisa Vogel 791-5848
 Meryl Leshansky

Administrative Committees

Delegates to Council
 Art Enrichment
 Banking Co-ordinator
 By-Laws
 Class Parent Co-ordinators
 Historian
 Hospitality
 Legislation
 Newsletter
 Nutrition Rep.
 Publicity
 School Board Rep.
 School Pictures
 6th Grade Yearbook
 Teacher Recognition Day
 Volunteer Appreciation
 Winter Brunch

Programming Committees

Committee Chairperson
 Reflections
 PAPP
 Pre-School
 Field Day
 Chairperson
 Book Fair
 Candy & Giftwrap Sale
 Carnival

Fashion Show
 Kids' Surprise Event
 Holiday Boutique
 Plant Sale
 Pumpkin Sale
 Summer Book Fair
 PTA Cookbook

Joan Rondinelli 791-5862
 Eleanor Haber 791-1293
 Sharon Hirsh 791-5142
 Eleanor Haber 791-1293
 Marianne Tomasulo 791-2659
 Helene Steiner 791-2971
 Sharon Hirsh 791-5142
 Mindy Ram 791-9592
 Janet Bleier 791-4353
 Holly Bobrow 791-5749
 Alicia Barreto 791-2019
 Marilyn Lefcort 791-3724
 Risa Spritzer 791-9644
 Maria Fletcher 791-3719
 Anne Falley 791-6231
 Charlotte Lurie 791-8662
 Colleen Hickey 791-4479
 Cathy Hicks 825-1858

FOREST CLASS PARENT LIST

GRADE	ROOM	CLASS PARENT	TEACHER
K	201	*Karen Jacobson	M. Barry
K	201	Lisa Vogel	M. Barry
K	201	Sheryl Zaretsky	M. Barry
K	202	*Henene Steiner	S. Moskowitz
K	202	Wendie Ciorciari	S. Moskowitz
K	202	Marianne Tomasulo	S. Moskowitz
1st	204	*Colleen Hickey	P. Badalucco
1st	204	Beatrice Karmin	P. Badalucco
1st	204	Cindy Farber	P. Badalucco
1st	207	*Sharon Blackman	G. Guttman
1st	207	Mona Schantz	G. Guttman
1st	207	Denise Sanchez	G. Guttman
2nd	205	*Ellie Haber	M. Ruschin
2nd	205	Tammy Weinstein	M. Ruschin
2nd	205	Meryl Leshansky	M. Ruschin
2nd	206	*Joan Rondinelli	M. Ruschin
2nd	206	Linda Esna	E. Fitzgerald
2nd	206	Pamela Galloppini	E. Fitzgerald
3rd	213	*Sharon Hirsh	E. Fitzgerald
3rd	213	Usha Shah	N. Blankshine
3rd	213	Andrea Spector	N. Blankshine
3rd	209	*Penny Eisenberg	N. Blankshine
3rd	209	Charlotte Lurie	S. Walsh
3rd	209	Arlene Lynn	S. Walsh
4th	210	*Andrea Bretscher	S. Walsh
4th	210	Laura Silverman	E. Cudahy
4th	210	Alicia Barreto	E. Cudahy
4th	211	*Carol Ignaciuk	S. Stiefel
4th	211	Lynn Smolin	S. Stiefel
4th	211	Susan Aviza	S. Stiefel
5th	216	*Risa Spritzer	A. Needleman
5th	216	Debbie Conan	A. Needleman
5th	216	Cathy Hicks	A. Needleman
5th	219	*Ruth Klein	S. Lewis
5th	219	Bonnie Epstein	S. Lewis
5th	219	Alison Smith	S. Lewis
6th	217	*Robin Laurentz	B. Lesser
6th	217	Holly Bobrow	B. Lesser
6th	217	Sheryl Weiner	B. Lesser
6th	220	*Janet Bleier	L. Kessler
6th	220	Nadine Fox	L. Kessler
6th	220	Maria Fletcher	L. Kessler
PLC	203	TBD	L. Kessler
LC 1	208	*Sharon Cohen	G. Haggerty
LC 2	215A	Marilyn Lefcort	C. Wood
LC 2	215A	*Lisa Rostron	C. Wood
LC 2	215A	Farah Allen	D. Terrell
LC 2	215A	Maryann Stampfl	D. Terrell

***Class Parent Rep.**

TEL NO	TEACHER
791-1278	M. Barry
568-1901	M. Barry
791-1186	M. Barry
791-2971	S. Moskowitz
791-4266	S. Moskowitz
791-2659	S. Moskowitz
791-4479	P. Badalucco
791-1875	P. Badalucco
792-0964	P. Badalucco
791-4245	G. Guttman
791-7902	G. Guttman
823-7224	G. Guttman
791-1293	M. Ruschin
791-5870	M. Ruschin
791-3848	M. Ruschin
791-5862	E. Fitzgerald
791-4725	E. Fitzgerald
791-2899	E. Fitzgerald
791-5142	N. Blankshine
791-4733	N. Blankshine
791-1453	N. Blankshine
791-8109	S. Walsh
791-8662	S. Walsh
791-8995	S. Walsh
791-2248	E. Cudahy
791-4928	E. Cudahy
791-2019	E. Cudahy
791-3397	S. Stiefel
791-6136	S. Stiefel
791-7053	S. Stiefel
791-9644	A. Needleman
825-3118	A. Needleman
825-1858	A. Needleman
791-6226	S. Lewis
791-7552	S. Lewis
791-6028	S. Lewis
791-3765	B. Lesser
791-5749	B. Lesser
791-2613	B. Lesser
791-4353	L. Kessler
791-3907	L. Kessler
791-3719	L. Kessler
791-1431	G. Haggerty
791-3729	C. Wood
561-8798	C. Wood
825-0127	D. Terrell
285-4746	D. Terrell

SHAW AVENUE PARENT TEACHER ASSOCIATION 1996-1997

POSITION

Co-Presidents
 1st Vice President
 2nd Vice President
 Honorary VP
 Treasurer
 Rec. Secretary
 Corr. Secretary
 Assistant to Treasurer
 Delegate to Council
 Teacher Delegate

ELECTED OFFICERS

Sandi Procida
 Liz Shaw
 Fran Buccalo
 Tracey Blanchflower
 Stanley Kaminsky
 Lisa Spano
 Debbie Dolan
 Barbara DeVivo
 Vivian Rainone
 Lisa DelCampo
 Kathy Vagnone
 Sandy Rubin

TEL.NO.

825-7987
 825-8678
 561-2357
 285-7190
 Faculty
 285-7057
 285-7483
 285-6738
 872-1132
 872-1332
 825-3849
 Faculty

COMMITTEE CHAIRPERSONS

Arts in Education
 Banking
 Birthday Calendar
 Book Fair
 Breakfast w/Santa
 Cupcake Sale
 Dance & Twirl Inf.
 Dance & Twirl Reg.
 Father's Day Boutique
 Field/Play Days
 Fingerprinting
 Gift Wrap Sale
 Grade Rep. Coordinator
 Holiday Boutique
 Hospitality
 Installation Dinner
 Jr. Bowling
 KARE
 Kids Bingo
 Labels for Education
 Ladies Volleyball (Tues.)
 Ladies Volleyball (Wed.)
 Membership
 Moonlight Bowl
 Mothers Day Boutique
 New Parents Tea
 Newsletter
 Nutrition
 Parent/Child Dances
 PARP
 Public Relations
 Pumpkin Patch
 Reflections
 School Barbecue
 School Board Rep.

PTA EXECUTIVE BOARD

Lisa Del Campo
 PTA EXECUTIVE BOARD
 Marilyn Gauger
 Kathy Vagnone
 PTA EXECUTIVE BOARD
 Kathy Vagnone
 Debbie Walsh
 Joanne Zdanke
 Lisa Dwyer
 Ginny Gregory
 Carol Andrews
 Tara Starna
 PTA EXECUTIVE BOARD
 Vivian Rainone
 Tara Starna
 Anne Buffalin
 Maryann Antoniato
 Debbie Bannon
 Nancy Barnett
 Mary Berman
 Lorraine Brooks
 Willie Andreola
 Josephine Engle
 Lisa Dwyer
 Lisa DelCampo
 Debbie Dolan
 Fran Buccalo
 Mary Berman
 Debbie Dolan
 Debbie Walsh
 Ginny Gregory
 Mary Berman
 Vivian Rainone
 Mary Aumuller
 Elise Antonelli
 PTA EXECUTIVE BOARD
 Chris Vessely

PTA EXECUTIVE BOARD

872-1332
 285-4733
 825-3849
 825-3849
 561-1387
 568-0498
 568-2779
 825-2291
 561-2030
 561-3613
 872-1132
 561-3613
 561-0742
 285-4652
 285-6620
 872-7503
 872-2736
 568-1479
 561-1902
 568-2779
 872-9105
 285-9611
 872-1332
 285-7483
 561-2357
 568-1479
 285-7483
 561-1387
 825-2291
 568-1479
 872-1132
 285-0439
 872-8179
 285-5736

Vivian Rainone
 Lorraine Maggio
 Vivian Rainone
 Maryanne Cooke
 Marilyn Gauger
 PTA EXECUTIVE BOARD
 Jeanine Panarelli
 Carol Andrews
 Sandi Procida

School Pictures
 Sixth Grade T-Shirts
 Sixth Grade Yearbook
 Spring Candy Sale
 Supermarket Bingo
 T-Shirt/Sweatshirt Sale
 Teacher/Staff Recognition

SHAW CLASS PARENT LIST

Grade	Class Parent	Tel.No.	Teacher	Room
K	Diane Velsor	285-6162	M. Rienhard	101
K	Mary Aumuller	285-0439	M. Schweigert	102
K	Janet Maci	561-0588	K. Milano	104
K	Dolores Jacobsen	568-9894	J. Neary	106
K	Joanne Cronin	825-2506		
1	Valerie Barcheski	561-9447	E. Haydock	103
1	Maryann Lapolla	568-0439	N. Bart	105
1	Jeanine Panarelli	561-5816	D. Ging	109
1	Deborah Walsh	561-1387	P. Amalfitano	110
1	Tara Starna	561-3613		
2	Debbie Bannon	285-9873	J. Baccon	108
2	JoAnne Mandzik	872-8723	M. Ficarrotta	111
2	Joann Romano	825-0634	J. Geffner	130
2	Lora-Jean Puccio	825-0334	G. Starler	131
2	Theresa Berstein	285-5382	J. Post	133
2	Diane Velsor	285-6162		
3	Linda Roach	561-1423	S. Lipski	126
3	Kathy Vagnone	825-3849	J. Lufrano	132
3	Deborah Dolan	285-7483	J. Ferranti	135
3	Marianne Fiorito	285-0015		
4	Pat Spotteck	561-8754	L. Benedetto	114
4	Barbara DeVivo	285-6738	G. Beyer	118
4	Lisa Dwyer	568-2779	P. Garvey	120
4	Lisa DelCampo	872-1332	J. Badaracco	127
4	Maria Maltenfort	561-9792		
5	Jo Constantelos	285-7534	C. Riccobono	100
5	Margaret Riccio	561-3272	S. Wasserman	116
5	Marianne Yuriditsky	872-0772	A. Upton	121
5	Nancy Barnett	872-2736	S. Perrone	122
5	Paulette Michelle	872-6732		
6	Laurie Graziano	872-6109	C. Lanell	123
6	Laura Amico	825-3196	G. Sherman	124
6	Vivian Rainone	872-1132	M. Buckley	125
6	Maria DiGiario	872-0831		
6	Barbara Long	872-0374	R. Decker	129
LCIII	Grade Rep.			
LCIII				

August
 Su M Tu W Th F Sa
 4 5 6 7 8 9 10
 11 12 13 14 15 16 17
 18 19 20 21 22 23 24
 25 26 27 28 29 30 31

October
 Su M Tu W Th F Sa
 6 7 8 9 10 11 12
 13 14 15 16 17 18 19
 20 21 22 23 24 25 26
 27 28 29 30 31

SEPTEMBER 1996

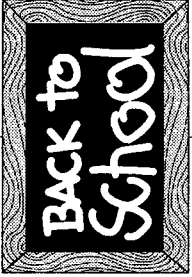
SUNDAY	MONDAY	TUESDAY	WEDNESDAY	THURSDAY	FRIDAY	SATURDAY
1	2 LABOR DAY	3 Superintendent's Conference Day (No School for Students) VSCHSD Bd. of Ed. Comm Mtg. 8 P.M.	4 Schools Open	5	6 Forest PTA New Parents Breakfast 8:45 A.M.	7
8	9 SEPTA Mtg. MEM. JHS 8 P.M.	10 PRIMARY ELECTION 6 A.M. - 9 P.M. Forest/Shaw (School in session) Forest PTA Exec. Bd. Mtg. 8:30 A.M. VSCHSD Bd. of Ed. Mtg. 8:30 P.M.	11	12 Clear Stream/Forest/ Shaw Meet the Teacher Night 7:30 P.M.	13 Shaw New Parents Tea 8:30 A.M. to 11 A.M.	14
15	16 Shaw PTA Exec. & Gen. Mtg. 7 P.M. Dist. 30 Bd. of Ed. Comm. Mtg. 8 P.M.	17	18 Clear Stream Banking Registration 3 P.M. - 4:30 P.M. Shaw Bowling Registration 2:45 P.M. - 3 P.M. Clear Stream New Parents Tea 7 P.M. & Gen. Mtg. 8 P.M. Forest PTA Class Parents & Gen. Mtg. 7:30 P.M.	19	20 Forest Road School Pictures Shaw Dance & Twirl Reg. 2:45 P.M. - 3:15 P.M.	21
22	23 YOM KIPPUR (School Closed)	24 Shaw Gift Wrap Sale Begins	25 Clear Stream Fingerprinting 9 A.M. - 11 A.M.	26	27 Forest Candy/Gift Wrap Sale Begins	28
29	30 Shaw Banking Begins Dist. 30 Bd. of Ed. Mtg. 8 P.M.			SHADED BOX INDICATES SCHOOL IS CLOSED		



September
 Su M Tu W Th F Sa
 1 2 3 4 5 6 7
 8 9 10 11 12 13 14
 15 16 17 18 19 20 21
 22 23 24 25 26 27 28
 29 30



OCTOBER 1996

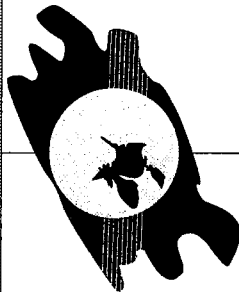

November
 Su M Tu W Th F Sa
 1 2 3 4 5 6 7 8 9
 10 11 12 13 14 15 16
 17 18 19 20 21 22 23
 24 25 26 27 28 29 30

SUNDAY	MONDAY	TUESDAY	WEDNESDAY	THURSDAY	FRIDAY	SATURDAY
6 	7 Shaw Dance Begins ✓ Shaw PTA Exec. & Gen. Mtg. 7 P.M. ✓ VS PTA Council Mtg. 8 P.M. Carbonaro	8 ✓ Forest PTA Exec. Bd. Mtg. 8:30 A.M. Clear Stream Banking Clear Stream Grade 6 Outdoor Education Program Shaw Banking Reg. Begins ✓ VSCHSD Bd. of Ed. Mtg. 8:30 P.M.	9 ✓ Clear Stream PTA Mtg. 9 A.M. Shaw Fingerprinting ✓ VSCHSD Bd. of Ed. Comm. Mtg. 8 P.M.	10 Forest Candy/Gift Wrap Sale Ends Clear Stream Grade 6 Outdoor Education Program	11 Shaw Twirl Begins	12
13 ✓	14 COLUMBUS DAY (School Closed)	15 Clear Stream Banking	16 Shaw Picture Day	17	18 ✓ Breakfast w/Supt. Clear Stream 9:30 A.M.	19
20	21 ✓ SEPTA MTG. MEM. JHS 8 P.M. ✓ Dist. 30 Bd. of Ed. Comm. Mtg. 8 P.M.	22 Clear Stream Banking Shaw Banking Reg. Ends	23 ✓ Forest PTA Gen. Mtg. 8 P.M.	24 Clear Stream Pumpkin Patch half day	25 Clear Stream Candy Sale Ends	26
27	28 ✓ Dist. 30 Bd. of Ed. Mtg. 8 P.M.	29 Clear Stream Banking	30	31 HALLOWEEN		

SHADED BOX
INDICATES
SCHOOL IS CLOSED

October
 Su M Tu W Th F Sa
 1 2 3 4 5
 6 7 8 9 10 11 12
 13 14 15 16 17 18 19
 20 21 22 23 24 25 26
 27 28 29 30 31

NOVEMBER 1996

November
 Su M Tu W Th F Sa
 1 2 3 4 5 6 7
 8 9 10 11 12 13 14
 15 16 17 18 19 20 21
 22 23 24 25 26 27 28
 29 30 31

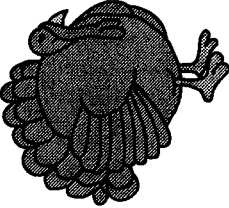
SUNDAY	MONDAY	TUESDAY	WEDNESDAY	THURSDAY	FRIDAY	SATURDAY
					1	2 Dist. 30 Bldg. Inspection
3	4 Shaw PTA Exec. & Gen. Mtg. 7 P.M.	5 ELECTION DAY 6 A.M. - 9 P.M. FOREST/SHAW Superintendent's Conference Day (No School for Students) VSCHSD Bd. of Ed. Comm. Mtg. 8 P.M.	6 Clear Stream PTA Exec. & Gen. Mtg. 6:45 P.M. Forest PTA Fashion Show 7 P.M.	7 Shaw Book Fair 8:30 A.M. - 2:30 P.M. Shaw Banking Gr. 3-6 & LC 8 A.M. - 8:20 A.M.	8	9
10	11 VETERANS DAY School Closed	12 Clear Stream Reflections Begins Clear Stream Banking Forest PTA Exec. Bd. Mtg. 8:30 A.M. VSCHSD Bd. of Ed. Mtg. 8:30 P.M.	13	14	15 Shaw Breakfast/w Santa ticket sale 2:45 - 3:15 P.M.	16
17	18 SEPTA Mtg. Mem. JHS 8 P.M. Dist. 30 Bd. of Ed. Comm. Mtg. 8 P.M.	19 Clear Stream Banking Forest PTA Gen. Mtg. 8:30 A.M. Clear Stream Pre-school Mtg. 1:30 P.M. Shaw Banking Gr. K - 2 8 A.M. - 8:20 A.M.	20 Clear Stream Book Fair All Day	21 Shaw Banking Gr. 3 - 6 & LC 8 A.M. - 8:20 A.M. Clear Stream Book Fair half day	22 Clear Stream Reflections End	23
24	25 Dist. 30 Bd. of Ed. Mtg. 8 P.M.	26 Clear Stream Banking	27 Forest Thanksgiving Breakfast Shaw Picture Retake Day	28 THANKSGIVING DAY School Closed	29 School Closed	30 SHADED BOX INDICATES SCHOOL IS CLOSED



November

Su	M	Tu	W	Th	F	Sa
3	4	5	6	7	8	9
10	11	12	13	14	15	16
17	18	19	20	21	22	23
24	25	26	27	28	29	30

DECEMBER 1996



January

Su	M	Tu	W	Th	F	Sa
5	6	7	8	9	10	11
12	13	14	15	16	17	18
19	20	21	22	23	24	25
26	27	28	29	30	31	

SUNDAY	MONDAY	TUESDAY	WEDNESDAY	THURSDAY	FRIDAY	SATURDAY
1	2 VS PTA Council Mtg. 8 P.M. Clear Stream	3 Shaw Banking Gr. K - 2	4 ✓ Clear Stream PTA Mtg. 9 A.M. Forest Holiday Boutique 9 A.M. - 2:30 P.M.	5 Clear Stream/Forest/Shaw Holiday Boutique 9 A.M. - 2:30 P.M. Shaw Banking Gr. 3 - 6 & LC	6 Clear Stream Holiday Boutique A.M.	7 ✓ Clear Stream Breakfast w/Santa 10 AM - 12 PM
8	9 VS PTA Council Mtg. 8 P.M. Clear Stream	10 ✓ Forest PTA Exec. Bd. Mtg. 8:30 A.M. Clear Stream Banking	11 VSCHSD Bd. of Ed. Comm. Mtg. 8 P.M.	12	13 Shaw No Twirl	14 ✓ Shaw Breakfast w/Santa 9 - 11 A.M.
15	16 Dist. 30 Bd. of Ed. Mtg. 8 P.M.	17 VSCHSD Bd. of Ed. Mtg. 8:30 P.M.	18 <i>30 Shaw Concert</i>	19 Shaw Banking Gr. 3 - 6 & LC	20 Clear Stream Winter Melodies PM	21
22	23 School Closed	24 Shaw Banking Gr. K - 2 <i>Forest Concert</i>	25 CHRISTMAS DAY	26	27	28
29	30 School Closed	31 School Closed				

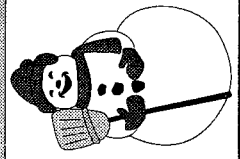

SHADED BOX INDICATES SCHOOL IS CLOSED

December
 Su M Tu W Th F Sa
 1 2 3 4 5 6 7
 8 9 10 11 12 13 14
 15 16 17 18 19 20 21
 22 23 24 25 26 27 28
 29 30 31

JANUARY 1997

February
 Su M Tu W Th F Sa
 1 2 3 4 5 6 7 8
 9 10 11 12 13 14 15
 16 17 18 19 20 21 22
 23 24 25 26 27 28

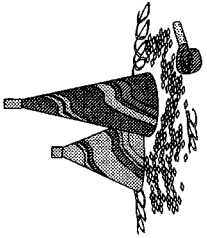
SUNDAY	MONDAY	TUESDAY	WEDNESDAY	THURSDAY	FRIDAY	SATURDAY
			1 NEW YEAR'S DAY School Closed	2 Schools Reopen	3	4
5	6 Shaw PTA Exec. & Gen. Mtg. 7 P.M.	7 Clear Stream Banking Shaw Banking Gr. K - 2 VSCHSD Bd. of Ed. Comm. Mtg. 8 P.M.	8 Forest PTA Winter Breakfast <i>2 Compact Mtg.</i> Clear Stream PTA Exec. & Gen. Mtg. 6:45 P.M.	9 Shaw Banking Gr. 3 - 6 & LC	10 Breakfast w/Supt. Shaw 9:30 A.M. Clear Stream Parp Begins	11
12	13 Dist. 30 Bd. of Ed. Comm. Mtg. 8 P.M.	14 Forest PTA Exec. Bd. Mtg. 8:30 A.M. Clear Stream Banking VSCHSD Bd. of Ed. Mtg. 8:30 P.M.	15 <i>11:30 Secs Deced.</i>	16	17 Shaw No Twirl Clear Stream Reflections Night 7 P.M.	18 Forest Kid's Surprise Day Shaw Fun Fair 10 A.M. - 2 P.M.
19	20 Martin Luther King, Jr. Day (School Closed) Dist. 30 Bd. of Ed. Comm. Mtg. 8 P.M.	21 Clear Stream Banking Shaw Banking Gr. K - 2 <i>8 pm w/ Sp. Support.</i>	22 <i>8:30 NCCross Hofstun</i>	23 Shaw Cupcake Sale Shaw Banking Gr. 3 - 6 & LC Clear Stream Supermarket Bingo 7 P.M.	24	25
26	27 <i>7:00 Sh. vs. Heston</i> Dist. 30 Bd. of Ed. Mtg. 8 P.M.	28 Clear Stream Banking Forest PTA PARP Begins	29 Clear Stream Cupcake Sale 1:30-3:15 P.M. Forest Book Fair <i>Str. Bds.</i>	30 Forest PTA Gen. Mtg. 9 A.M. Forest Book Fair	31 Forest Book Fair	SHADED BOX INDICATES SCHOOL IS CLOSED





January
 Su M Tu W Th F Sa
 5 6 7 8 9 10 11
 12 13 14 15 16 17 18
 19 20 21 22 23 24 25
 26 27 28 29 30 31



March
 Su M Tu W Th F Sa
 2 3 4 5 6 7 8
 9 10 11 12 13 14 15
 16 17 18 19 20 21 22
 23 24 25 26 27 28 29
 30 31

FEBRUARY 1997

SUNDAY	MONDAY	TUESDAY	WEDNESDAY	THURSDAY	FRIDAY	SATURDAY
SHADED BOX INDICATES SCHOOL IS CLOSED	 Shaw Candy Sale Begins ✓ Shaw PTA Exec. & Gen. Mtg. 7 P.M. ✓ VS PTA Council Mtg. 8 P.M. Howell Rd.	 Clear Stream Banking Shaw Banking Gr. K - 2 ✓ VSCHSD Bd. of Ed. Comm. Mtg. 8 P.M.	5 ✓ Clear Stream PTA Mtg. 9 A.M. Clear Stream T-Shirt Sale 2 - 3:15 P.M.	6 Shaw Banking Gr. 3 - 6 & LC Clear Stream T-Shirt Sale 2 - 3:15 P.M.	7 Clear Stream PARP ends ✓ Clear Stream Parent-Child Night 7 P.M.	1 VSCHSD School Board Budget Review Shaw Moonlight Bowl
9	10 ✓ SEPTA MTG. MEM. JHS 8 P.M.	11 Forest PTA Exec. Bd. Mtg. 8:30 A.M. Clear Stream Banking ✓ VSCHSD Bd. of Ed. Mtg. 8:30 P.M.	12 LINCOLN'S BIRTHDAY PTA FOUNDERS DAY AT SHAW 7:30 P.M.	13	14 Shaw Candy Sale Ends	15
16 ✓	17 School Closed	18	19	20	21	22 WASHINGTON'S BIRTHDAY
23	24 ✓ Dist. 30 Bd. of Ed. Mtg. 8 P.M.	25 Clear Stream Banking Shaw Banking Gr. K-2	26	27 Shaw Banking Gr. 3 - 6 & LC	28	

February

Su M Tu W Th F Sa
 2 3 4 5 6 7 8
 9 10 11 12 13 14 15
 16 17 18 19 20 21 22
 23 24 25 26 27 28

MARCH 1997

April

Su M Tu W Th F Sa
 1 2 3 4 5
 6 7 8 9 10 11 12
 13 14 15 16 17 18 19
 20 21 22 23 24 25 26
 27 28 29 30

SUNDAY	MONDAY	TUESDAY	WEDNESDAY	THURSDAY	FRIDAY	SATURDAY
<p>SHADED BOX INDICATES SCHOOL IS CLOSED</p>						<p>1</p>
2	3 Shaw PARP Begins Shaw PTA Exec. & Gen. Mtg. 7 P.M.	4 Forest PTA Exec. Bd. Mtg. 8:30 A.M. Clear Stream Banking Shaw Banking Gr. K - 2 V.SCHSD Bd. of Ed. Comm. Mtg. 8 P.M.	5 <i>T.T. Bd. Mtg. 7:30</i> <i>Memo to J.H.S. 7:30</i> Clear Stream PTA Exec. & Gen. Mtg. 6:45 P.M.	6 Shaw Banking Gr. 3 - 6 & LC	7 Shaw No Twirl	8 <i>ok</i> Forest PTA Carnival 11 A.M. - 3 P.M.
9	10 Shaw No Dance SEPTA MTG. MEM. JHS 8 P.M.	11 Clear Stream Banking V.SCHSD Bd. of Ed. Mtg. 8:30 P.M.	12	13 <i>ok</i>	14 <i>ok</i> Shaw No Twirl <i>Shaw No Twirl</i> <i>Forest Heccepshead</i> <i>Rest Shaw Supermarket</i> Bingo 7 P.M.	15 V.S. PTA Council Legislative Breakfast Mem. J.H.S.
16	17 <i>Shaw open Forest</i> Dist. 30 Bd. of Ed. 7:00 Comm. Mtg. 8 P.M.	18 PTA DAY IN ALBANY Clear Stream Banking Shaw Banking Gr. K - 2	19 Clear Stream Pre-School Mtg. 1:30 P.M. Forest PTA New Parents Tour 7:30 P.M. Forest PTA Gen. Mtg. 8 P.M.	20 Forest Pre-School Mtg. 3 P.M. Shaw Banking Gr. 3 - 6 & LC	21 Breakfast w/Supt. Forest 9:30 A.M.	22
23	24 SCHOOL CLOSED	25 SCHOOL CLOSED	26 SCHOOL CLOSED	27 SCHOOL CLOSED	28	29
30	31 Dist. 30 Bd. of Ed. Mtg. 8 P.M.					

March
 Su M Tu W Th F Sa
 2 3 4 5 6 7 8
 9 10 11 12 13 14 15
 16 17 18 19 20 21 22
 23 24 25 26 27 28 29
 30 31

May
 Su M Tu W Th F Sa
 4 5 6 7 8 9 10
 11 12 13 14 15 16 17
 18 19 20 21 22 23 24
 25 26 27 28 29 30 31

APRIL 1997

SUNDAY	MONDAY	TUESDAY	WEDNESDAY	THURSDAY	FRIDAY	SATURDAY
6	7 SPRING VS PTA Exec. & Gen. Mtg. 7 P.M. VS PTA Council Mtg. 8 P.M. W.L. Buck	8 Forest PTA Exec. Bd. Mtg. 8:30 A.M. Clear Stream Banking VSCHSD Bd. of Ed. :Mtg. 8:30 P.M.	9 30 Sheet Concert J.T. Bds. 6:30 Mtg. 7:30 phase II	10 7:30 pm Clear Stream Spring Melodies P.M.	11 7:30 pm Clear Stream Spring Melodies P.M.	12 Shaw Kids Bingo 11 A.M. - 2 P.M.
13	14 KINDERGARTEN REGISTRATION All Schools 9 - 11 A.M. Shaw P ARP Ends SEPTA MTG. MEM. JHS 8 P.M. Dist. 30 Bd. of Ed. Comm. Mtg. 8 P.M.	15 KINDERGARTEN REGISTRATION Clear Stream Banking Shaw Banking Gr. K - 2	16 Forest Pre-School Mtg. 3 P.M. Shaw Banking Gr. 3 - 6 & LC	17 Forest Pre-School Mtg. 3 P.M. Shaw Banking Gr. 3 - 6 & LC	18 Forest Pre-School Mtg. 3 P.M. Shaw Banking Gr. 3 - 6 & LC	19 Forest Pre-School Mtg. 3 P.M. Shaw Banking Gr. 3 - 6 & LC
20	21 SCHOOL CLOSED Deadline for Filing Petitions for Trustee 5 P.M.	22 Earth Day	23 LIGHTS ON FOR EDUCATION MEM. JHS 7:30 P.M.	24 Forest Pre-School Mtg. 3 P.M. Shaw Banking Gr. 3 - 6 & LC	25 Forest Pre-School Mtg. 3 P.M. Shaw Banking Gr. 3 - 6 & LC	26 Forest Pre-School Mtg. 3 P.M. Shaw Banking Gr. 3 - 6 & LC
27	28 7:30 pm VS PTA Exec. & Gen. Mtg. 7 P.M.	29 Clear Stream Banking BOCES BUDGET VOTE 8 P.M. w/Dist. 30 Bd. of Ed. Mtg. following.	30 Forest PTA Gen. Mtr. 8 P.M.	31 Forest PTA Gen. Mtr. 8 P.M.	32 Forest PTA Gen. Mtr. 8 P.M.	33 Forest PTA Gen. Mtr. 8 P.M.

April

Su	M	Tu	W	Th	F	Sa
6	7	8	9	10	11	12
13	14	15	16	17	18	19
20	21	22	23	24	25	26
27	28	29	30	31		

June

Su	M	Tu	W	Th	F	Sa
4	5	6	7	8	9	10
11	12	13	14	15	16	17
18	19	20	21	22	23	24
25	26	27	28	29	30	

3¹⁵ 2/4
June Plan

MAY 1997

SUNDAY	MONDAY	TUESDAY	WEDNESDAY	THURSDAY	FRIDAY	SATURDAY
SHADED BOX INDICATES SCHOOL IS CLOSED				1 ✓ Clear Stream Staff Recognition	2 ✓ Shaw Tot's to Teen's Show 7:30 P.M.	3
4	5 Shaw PTA Volunteer Night Exec. & Gen. Mtg. 7 P.M. SEPTA MTG. MEM. JHS 8 P.M. VSCSHD Bd. of Ed. Comm. Mtg. 8 P.M.	6 N.Y.S. PEP Gr. 5 Writing Test 9:15 A.M. Clear Stream Banking Shaw Banking Ends Gr. K-2 Budget Hearing (Dist. 13) 8 P.M. Dever	7 N.Y.S. PEP Gr. 3 & 6 Reading Test 9:15 A.M. Forest Plant Sale/Pre-Order Pick-up 11 A.M. Clear Stream PTA Exec. & Gen. Mtg. 6:45 P.M. Budget Hearing (Dist. 30) 8 P.M. Shaw	8 Forest Plant Sale 9 A.M. - 2:30 P.M. Shaw Mother's Day Boutique 9 A.M. - 2:30 P.M. Shaw Banking Ends Gr. 3 - 6 & LC Budget Hearing (Dist. 24) 8:15 P.M. W.L. Buck	9 Forest Plant Sale 9 A.M. - 2:30 P.M. Clear Stream Mother's Day Boutique All Day Shaw Boys Escort Dance 7:30 - 10 P.M.	10
11	12 Voter Registration 7-9 A.M. & 9 P.M. All Schools N.Y.S. PEP Gr. 3 Writing Test 9:15 A.M. Clear Stream Banking Forest PTA Exec. Bd. Mtg. 8:30 A.M. Clear Stream Pre-School Mtg. 7:30 P.M. VSCSHD Bd. of Ed. Mtg. 8:30 P.M.	13 N.Y.S. PEP Gr. 3 & 6 Math Test 9:15 A.M. 11:30 Clear Stream Bd.	14 N.Y.S. PEP Gr. 3 & 6 Math Test 9:15 A.M.	15 Forest Pre-School Mtg. 3 P.M.	16 ✓ Shaw PTA Teachers Recognition Retirement Dinner	17 9-12 P.M. PTA
18	19 ✓ Dist. 30 Bd. of Ed. Mtg. 8 P.M.	20 ✓ VOTING ALL SCHOOLS 7 AM - 10 PM ✓ DISTRICT ART EXHIBIT 7:30 P.M. - 9 P.M.	21	22	23	24
25	26 MEMORIAL DAY (School Closed) Memorial Day Parade 9 A.M.	27 Clear Stream Banking Forest PTA Installation Dinner	28 2 Bds. JHS 30 6:30	29 Forest Road Field Day	30 Shaw PTA Installation Dinner	31



May						
Su	M	Tu	W	Th	F	Sa
1	2	3	4	5	6	7
8	9	10	11	12	13	14
15	16	17	18	19	20	21
22	23	24	25	26	27	28
29	30	31				

JUNE 1997

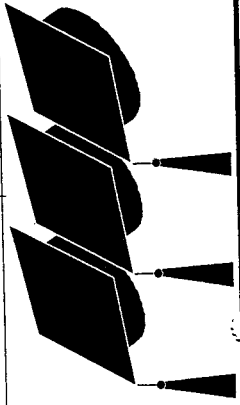

July						
Su	M	Tu	W	Th	F	Sa
1	2	3	4	5	6	7
8	9	10	11	12	13	14
15	16	17	18	19	20	21
22	23	24	25	26	27	28
29	30	31				

SUNDAY	MONDAY	TUESDAY	WEDNESDAY	THURSDAY	FRIDAY	SATURDAY
1	2 VS PTA Council Mtg. 8 P.M. South H.S. VSCHSD Bd. of Ed. Comm. Mtg. 8 P.M.	3 Clear Stream Banking	4 Clear Stream PTA Mtg. 9 A.M. Forest PTA Staff Appreciation Luncheon Clear Stream PTA Installation Dinner 7 P.M.	5 Forest Road Field Day (rain date)	6	7
8	9 <i>Jt. Bds. 2. 6/3/90 7</i> Shaw PTA Social Mtg. 7 P.M.	10 Clear Stream Banking VSCHSD Bd. of Ed. Mtg. 8:30 P.M.	11	12 Clear Stream/Shaw Father's Day Boutique 9 A.M. - 2:30 P.M.	13 Forest PTA Volunteer Appreciation Brunch 9:30 A.M. Shaw Girls Escort Dance 7:30 - 10 P.M.	14 FLAG DAY
15	16 SEPTA MTG. MEM. JHS 8 P.M. Dist. 30 Bd. of Ed. Comm. Mtg. 8 P.M.	17 Shaw Field Day	18	19 Forest PTA Book Fair 9 A.M. - 2:30 P.M. Shaw Play Day	20 Forest PTA Book Fair 9 A.M. - 2:30 P.M.	21
22	23 Dist. 30 Bd. of Ed. Mtg. 8 P.M.	24	25 CLEAR STREAM/ FOREST/SHAW 6th Gr. Closing Exercises 8:15 P.M.	26 CLEAR STREAM/ FOREST/SHAW Kindergarten Graduation 9 A.M. Clear Stream/Forest/ Shaw 6th Gr. Parties 1 - 3 P.M. Shaw PTA Barbeque	27 Last Day of School	28
29	30					SHADED BOX INDICATES SCHOOL IS CLOSED

SEPTA

Valley Stream Officers for 1996-1997

- Co-Presidents: Pat McCormick 285-8618
Kathy Russo 872-9393
- Vice Presidents: Joanna Ortiz 285-1567
Robert Musmacher 568-9604
- Hon. Vice Pres. Mr. Lawrence McGoldrick
- Treasurer: Rosemary Rader 872-8669
- Rec. Secretary: Gregory Ferraro 887-9384
- Correspond. Secty.: Lorraine Radice 825-0667
- Delegate to Council: Trish Rakow 887-7278
- Delegate to SEPTA/BOCES: Carol Belmonte 285-6267
- Past Presidents: Barbara Bernsten 791-3983
Ronnie Swett 872-0513

Valley Stream Council of PTA's Elected Officers

- President: Annie Winn 825-5768
- First V. Pres. Nancy Vigorito 285-5471
- Scholarship: Anne Marie Konzet 825-2572
- Second V. Pres. Cathy Rotkowitz 599-1637
- Program: Sue Gagas 561-2134
- Treasurer: Ann Marie Costiglio 791-1799
- Rec. Secretary: Anne Winn 825-5768
- Correspond. Secty.:
- Past President:

JULY 1997

SUNDAY	MONDAY	TUESDAY	WEDNESDAY	THURSDAY	FRIDAY	SATURDAY
6 SHARED BOX INDICATES SCHOOL IS CLOSED	7	8	9	10	11	12
13	14	15	16	17	18	19
20	21	22	23	24	25	26
27	28	29	30	31		

AUGUST 1997

SUNDAY	MONDAY	TUESDAY	WEDNESDAY	THURSDAY	FRIDAY	SATURDAY
3	4	5	6	7	8	9
10	11	12	13	14	15	16
17	18	19	20	21	22	23
24	25	26 VSCHSD Bd. of Ed. Mtg. 8:30 P.M.	27	28	29	30
31						

*Printed by the Instructional Services Center
Valley Stream Central High School District*

Valley Stream District 30



Forest Road



Shaw Avenue

Clear
Stream Avenue

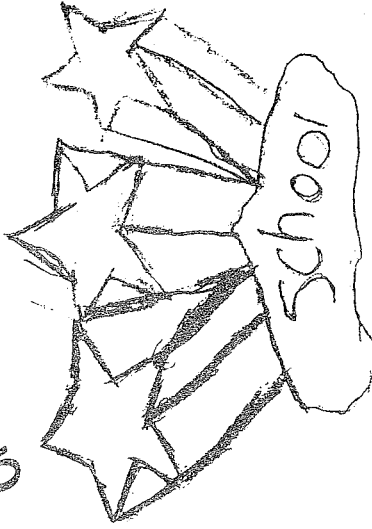

Calendar of Events 1997 - 1998

Published by the Board of Education and the Parent Teacher Associations

Board of Education

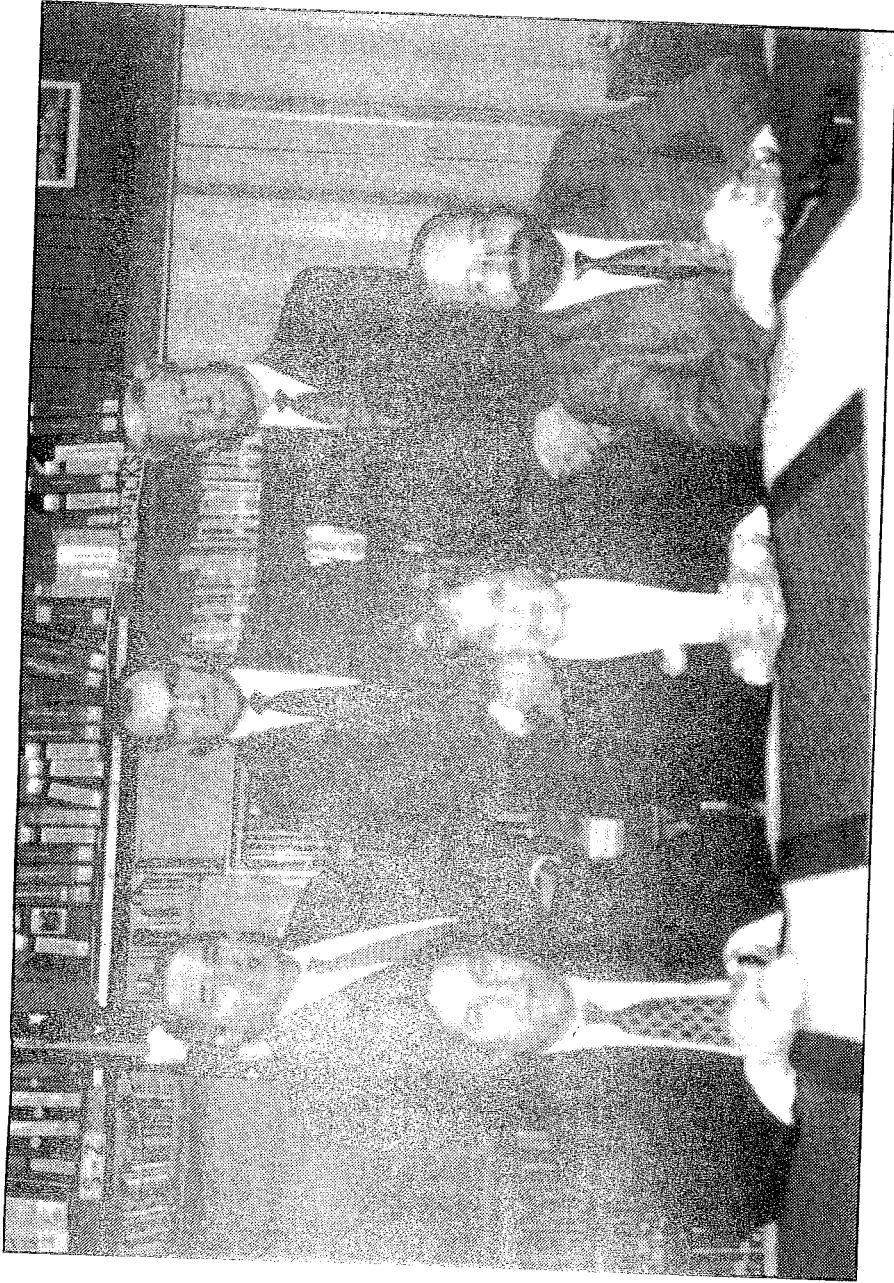

Standing (left to right): Thomas Galgano, Trustee; Lawrence R. McGoldrick, Superintendent of Schools; William Gauger Trustee
Seated (left to right): * Richard Eisenberg, Trustee; * Leonore Egan, Vice President; * Andrew Walters, President

*Also serves on the High School Board

SHAW AVENUE PARENT TEACHER ASSOCIATION 1997-1998

POSITION	ELECTED OFFICERS	TELEPHONE NO.	POSITION	ELECTED OFFICERS	TELEPHONE NO.
President	Sandi Procida	825-7987 / 256-1099	Installation Dinner	Maryann Antoniato	285-4652
1st Vice President	Kathy Vagnone	925-3849	Jr. Bowling	Debbie Bannon	285-6620
2nd Vice President	Lisa Spano	285-7057	KARE	Mary Berman	872-7503
Honorary VP	Stanley Kaminsky	Faculty	Labels for Education	Lorraine Brooks	568-1479
Treasurer	Debbie Dolan	285-7483	Ladies Volleyball (Tues.)	Willie Andreola	561-1902
Assistant to Treasurer	Vivian Rainone	872-1132	Ladies Volleyball (Wed.)	LoraJean Pucci	285-7073
Rec. Secretary	Tracey Blanchflower	285-7190	Membership	Diane Velsor	825-0334
Corr. Secretary	Chris Hertling	568-6051	Mothers Day Boutique	Sandi Procida	285-6162
Delegates to Council	Lisa DelCampo	872-1332	New Parents Tea	Rosann Colucci	825-7987
Teacher Delegate	Fran Buccola	561-2357	Newsletter	Tara Starna	561-3602
	Sandy Rubin	Faculty		Karen DePalma	561-3613
COMMITTEE CHAIRPERSONS			Nutrition	Debbie Dolan	285-8959
Arts in Education	Lisa Del Campo	872-1332	Parent/Child Dances	Debbie Walsh	285-7483
Banking	PTA EXECUTIVE BOARD		PARP	Mary Berman	561-1387
Birthday Calendar	Diane Velsor	285-6162	Public Relations	Delores Jacobsen	568-9894
Book Fair	Tara Starna	561-3613	Pumpkin Patch	Chris Hertling	568-6051
Breakfast w/Santa	PTA EXECUTIVE BOARD		Reflections	Mary Aumuller	285-0439
Cupcake Sale	Joann Baurman	285-7724	School Barbecue	Alysse Antonelli	872-8179
Dance & Twirl Inf.	Joanne Zdanko	568-0498	School Board Rep.	PTA EXECUTIVE BOARD	
Dance & Twirl Reg.	Fran Buccola	561-2357	School Pictures	Chris Vessely	285-5736
Father's Day Boutique	Tracey Blanchflower	285-7190	Sixth Grade T-Shirts	Vivian Rainone	872-1132
Field/Play Day	Diane Velsor	285-6162	Sixth Grade Yearbook	Debbie Dolan	285-7483
Field Day/Play T Shirts	Roseann Colucci	561-3602	Spring Candy Sale	Eileen Brady	872-0415
Fingerprinting	Tara Starna	561-3613	T Shirt/Sweatshirt Sale	Alysse Antonelli	872-8179
Gift Wrap Sale	Carol Andrews	561-2030	Teacher/Staff Recognition	PTA EXECUTIVE BOARD	
Grade Rep. Coordinator	Chris Hertling	568-6051	Yard Sale	Diane Bakich	872-6257
Holiday Boutique	PTA EXECUTIVE BOARD			Carolyn Andrews	561-2030
Hospitality	Vivian Rainone	872-1132		Diane Cascino	872-2126
	Sandi Procida	825-7987		Vivian Rainone	872-1132
	Ginny Gregory	825-2291		Nancy Barnett	872-2736
	Anne Buffalin	561-0742			

SEPTEMBER 1997

October
Su M Tu W Th F Sa
5 6 7 8 9 10 11
12 13 14 15 16 17 18
19 20 21 22 23 24 25
26 27 28 29 30 31

August
Su M Tu W Th F Sa
3 4 5 6 7 8 9
10 11 12 13 14 15 16
17 18 19 20 21 22 23
24 25 26 27 28 29 30
31

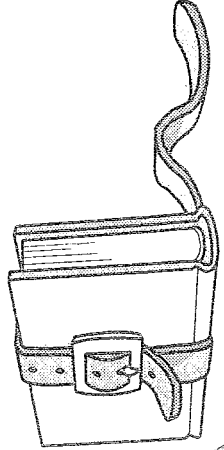
SUNDAY	MONDAY	TUESDAY	WEDNESDAY	THURSDAY	FRIDAY	SATURDAY
7 	1 LABOR DAY	2 Supt. Conference Day No School for Students VSCHSD Bd. of Ed. Comm. Mtg. 8 P.M.	3 Schools Open	4	5 Shaw New Parents Tea 8:30 A.M. to 11 A.M. Forest New Parents Breakfast, 8:45 A.M.	6
8	8 VS SEPTA Mtg. Mem. JHS 8 P.M.	9 PRIMARY ELECTION 6 A.M. - 9 P.M. Forest/Shaw (Schools in session) Forest PTA Exec. Bd. Mtg. 8:30 A.M. Shaw PTA Mtg. 8 P.M. VSCHSD Bd. of Ed. Mtg. 8:30 P.M.	10	11 Shaw T-Shirt Sale CLEAR STREAM/ FOREST/SHAW Meet the Teacher Night 7:30 P.M.	12	13
14	15 Dist. 30 Bd. of Ed. Comm. Mtg. 8 P.M.	16 Clear Stream New Parents Tea, 7 P.M. Clear Stream Gen. Mtg. 8 P.M.	17 Shaw Bowling Reg. 2:45 to 3 P.M. Forest PTA Class Parents Mtg. 7:30 P.M. Forest PTA Gen. Mtg. 8 P.M. Clear Stream Banking Reg. 3 P.M. - 4:30 P.M.	18 Clear Stream Banking Reg. 3 P.M. - 4:30 P.M.	19 Shaw Dance & Twirl Reg. 2:45 P.M. Forest School Pictures	20
21	22 Shaw Gift Wrap Begins Dist. 30 Bd. of Ed. Mtg. 8 P.M.	23 Forest Candy & Gift Wrap Sale Begins	24 Clear Stream Fingerprinting 9 A.M. - 11 A.M. Clear Stream T-Shirt Sale 2:15 P.M. - 3:15 P.M.	25 Clear Stream T-Shirt Sale 2:15 P.M. - 3:15 P.M.	26	27
28	29	30				SHADED BOX INDICATES SCHOOL IS CLOSED

CLEAR STREAM AVENUE PARENT TEACHER ASSOCIATION 1997-1998

POSITION	ELECTED OFFICERS	TELEPHONE	POSITION	ELECTED OFFICERS	TELEPHONE
Co-President	Rosann DiPalma	285-4036	Safety	Mirtho Denis	975-2591
Co-President	MaryAnne Lanz	285-7068	School & Community	Joanne Spano	285-6690
1st VP - Program	Joanne Spano	285-6690	SEPTA	Joanna Ortiz	285-3832
2nd VP-Pre-school	Pat Raykowski	285-5675	Streamer	Joanne Spano	285-6690
3rd VP-Ways & Means	Alice Swahn	285-8626		Sally Kaplan	825-3052
Hon. V.P.	Robert A. Cohen	872-4333	Grade Rep. Chairperson	Valerie Garcia	285-6639
Treasurer	Rosemary Miller	872-3224		Mary Sheffield	285-6221
Membership	Cathy Mule	872-2098	SPECIAL COMMITTEE CHAIRPERSONS		
Recording Secretary	Grace Porti	872-9627	Book Fair	Penny Preziotte	285-8313
Corresponding Secretary	Barbara Schehr	872-1380	Breakfast w/Santa	Sheila Kagan	872-5031
Delegates to Council	Lisa Manteria	561-8798		Kathy Heeb	285-4798
	Lisa Manteria	825-1961	Candy/Gift Wrap	Margaret Robar	285-5321
Teacher Delegate	Karen Catalano	Faculty		Lisa Manteria	825-1961
	Sandra Aragona	Faculty	Cupcake Sale	Carolyn Russo	561-5022
Past Presidents	Cathy Montefusco	561-7170		Grace Porti	872-9627
	Mary Sheffield	285-6221	Father's Day Sale	Pat Raykowski	285-5675
EXECUTIVE BOARD STANDING COMMITTEE CHAIRPERSONS					
Arts & Flyers	James Johnson	825-5029	Fashion Show	Alice Swahn	285-8626
	Carmella Tiseo	825-2158		Zana Antranik	568-9840
Auditing	Lisa Manteria	825-1961	Fingerprinting	Cathy Montefusco	561-7170
	Jarie Spezio	825-5762	Holiday Boutique	Joanna Ortiz	285-3832
Banking Co-ordinators	Marie Endrich	561-1906		Mary Breuer	285-4173
	Penny Preziotte	285-8313	Kids Night Out	Marie Bernero	285-7910
Birthday Calendar	Rita Carreras	285-9656		Joanne Novello	872-8229
	Mary MacLean	Faculty	Mother's Day Sale	Peggy Riccio	285-8140
	Joanne Novello	872-8229		Lois Singh	285-6011
Cultural Arts	Cathy Montefusco	561-7170	PARP	Lisa Manteria	285-1961
	Mary MacLean	Faculty	Pumpkin Patch	Carolyn Russo	561-5022
Hospitality	Jeanie Amoroso	285-1652	Reflections	Fran Lozano	872-9570
KARE	Phyllis Barbieri	825-5516	School Pictures	Rosemary Miller	872-3224
Legislation	Marie Endrich	561-1906	Staff Recognition	Michele O'Gara	285-4714
Nutrition	Brenda Spear	872-2703	Supermarket Bingo	Michelle Lentini	825-5122
Parent Awareness	Rosemary Miller	872-3224	T-Shirt Sale	Cathy Montefusco	561-7170
	Toni Steenbeek	285-5843		Mary Sheffield	285-6221
Procedures	Mary Sheffield	285-6221		Toni Steenbeek	285-5843
Publicity/Historian	Executive Board			Edie Nicholas	825-2624
	Fran Lozano	872-9570		Barbara Schehr	872-1380

FOREST ROAD PARENT TEACHER ASSOCIATION 1997-1998

POSITION	ELECTED OFFICERS	TELEPHONE NO.	POSITION	ELECTED OFFICERS	TELEPHONE NO.
Co-Presidents	Alison Smith	791-6028	Staff Recognition Days	Cathy Hicks	825-1858
1st Vice President	Jill Cohen	791-3407		Lisa Vogel	568-1901
2nd Vice President	Janet Bleier	791-4353	Volunteer Appreciation	Mindy Ram	791-9592
3rd Honorary Vice Pres.	Ways & Means		Programming Committees	Anne Falley	791-6231
Treasurer	Ruth Klein	791-6226	Committee Chairperson	Eily Haber	791-1293
Rec. Secretary	Dr. Barbara Warren Cronin	791-6134	Reflections	Charlotte Lurie	791-8662
Financial Secretary	Karen McDaniel	791-4574	PARP	Susan Viggiano	791-3705
	Lisa Aponite	791-2807		Sharon Hirsh	791-5142
	Lisa Vogel	568-1901	Pre-School	Linda Pellizzi	791-6582
			Field Day	Risa Spritzer	791-9644
				June Goldman	791-2666
				Linda Kettering	792-0526
				Andrea Bretscher	791-2248
				Janice Brown	791-9168
				Brigette LaPorte	791-6698
				Linda Pellizzi	791-6582
				Andrea Bretscher	791-2248
				Mindy Ram	791-9592
				Laura Silverman	791-4928
				Helene Steiner	791-2971
				Andrea Bretscher	791-2248
				Eily Haber	791-1293
				Sharon Hirsh	791-5142
				Janet Bleier	791-4353
				Andrea Bretscher	791-2248
				Robin Teramo	791-6698
				Sheryl Zaretsky	791-6322
				Wendie Ciorciari	791-1186
				Laura Feaser	791-4266
				Sherry Galvin	791-5904
				Lynn Smolin	791-6502
				Eily Haber	791-6136
				Sharon Hirsh	791-1293
				Marianne Tomasulo	791-5142
				Janet Bleier	791-2659
				Linda Pellizzi	791-4353
				Risa Spritzer	791-6582
				Debbie Cohan	791-9644
				Lisa Vogel	825-3118
				Eily Haber	568-1901
				Helene Harris	791-1293
				Maria Shea	791-2425
					791-606

EXECUTIVE BOARD COMMITTEE CHAIRPERSONS

Administrative Committees	Sharon Hirsh	791-5142
Delegates to Council	Anne Falley	791-6231
An Enrichment	Charlotte Lurie	791-8662
Banking Co-ordinator	Ruth Klein	791-6226
By-Laws	Laura Silverman	791-4928
Class Parent Co-ordinators	Helene Harris	791-8425
	Maira Shea	791-1606
	Lisa Vogel	568-1901
	Mara Steindam	791-8542
	Mara Steindam	791-8542
	Cathy Hicks	825-1858
	Lisa Vogel	568-1901
	June Goldman	791-2666
	Anne Falley	791-6231
	Susan Viggiano	791-3705
	Helene Harris	791-8425
	Eileen Popper	791-6276
	Anne Falley	791-6231
	Laura Silverman	791-4928
	Jill Cohen	791-3407
	Alison Smith	791-6208
	Ruth Klein	791-6226
	Karen Benison	791-7253
	Debbie Cohan	825-3118
	Cathy Hicks	825-1858

Fundraising Committees

Chairperson	Chairperson
Book Fair	Book Fair
Candy & Giftwrap Sale	Candy & Giftwrap Sale
Carnival	Carnival
Fashion Show	Fashion Show
Holiday Boutique	Holiday Boutique
Kids' Surprise Event	Kids' Surprise Event
Plant Sale	Plant Sale
Pumpkin Sale	Pumpkin Sale
Raffles	Raffles
Spring Boutique	Spring Boutique
Summer Book Fair	Summer Book Fair

School Policies

School Hours for all Schools

Kindergarten through Learning Special Classes: 8:30 a.m. to 2:45 p.m. First and high school students: 8:00 a.m. to 2:45 p.m. Please contact your school regarding availability of supervision for students who arrive before 8:20 a.m.

Breakfast

Students participating in the District Breakfast Program should not arrive before 7:50 a.m. Supervision is not provided for students prior to that time.

Lunch

Lunch is served beginning on the first day of school. Pupils may go home for lunch, bring lunch from home, or buy the school lunch in the cafeteria. Students are not permitted to bring money for lunch unless packed up by a parent or authorized adult. Monthly menus are provided. In case a child forgets or loses their lunch money, there is a charge system to cover the emergency. The secretary keeps the record of such charges and amounts. The parents should arrange to have the charges paid in a reasonable time. Students may purchase preparatory lunch tickets. Each ticket provides 20 meals, and is valid until June, or until all 20 meals are used. All tickets will remain with the Cafeteria Cashier.

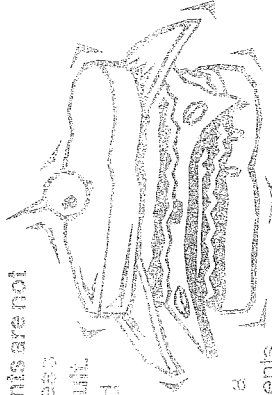

Snack Milk & Juice

Snack milk & juice are sold to all children beginning the first day of school. You will be notified as to exact date for payment. In case of a child's absence, no refund is made for period of less than a full week.

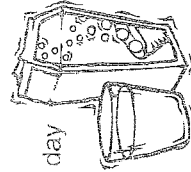

Absences

When your child has been absent, State law requires that he/she bring a note from you explaining the absences and the date(s) of absence(s). The note should be presented to the nurse before he/she goes to the classroom. Please be specific. Just saying, "he/she was ill", is not enough. Indicate whether it was "virus", "fever", "cold", etc.

A note is required for an absence due to a religious holiday. A note is required for any tardiness, giving the reason. If your child contacts a contagious disease,

such as mumps, measles, etc., please phone the school nurse so that she can alert the parents in your child's class that their children have been exposed. Be sure to keep the emergency card up to date so that we will know whom to call should your child become ill and have to go home.

Noon Hour Rules

Students who repeatedly misbehave in the cafeteria, auditorium, or on the playground during the noon hour, may be excluded from staying in school for lunch for a few days. If you receive such a note from the principal/teacher, we would appreciate your cooperation. Whether or not a parent is home during the noon hour has no bearing on this exclusion.

Exits and Entrances

Your child's class is assigned a specific exit and entrance to use. You will thus know where to meet him/her when you come to pick up. Parents picking up children are asked to meet them at the exit, **not the classroom**. Parents must wait outside the school at dismissal time.

Class Interruptions

No unnecessary interruptions of classes are allowed once the day's sessions have begun. When your child forgets a book, homework, sneakers, lunch money, etc., please bring these to the office. All pupils are instructed to check with the office at lunch time for such forgotten items. In the interest of the child's all-round education, we urge you not to make a practice of bringing forgotten items to school. The child should be developing his/her own sense of responsibility for these things.

Physical Education Attire and Sneakers

Boys and girls are required to wear appropriate attire and sneakers on assigned gym days. **NO ONE IS ALLOWED ON THE GYM FLOOR WITHOUT SNEAKERS.**

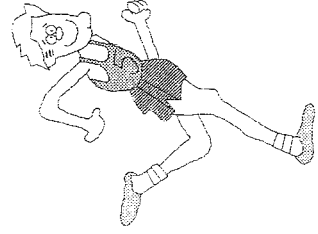

School Policies

Appointments with Teachers

In order that pupils' class time be used to the fullest advantage, we request that parents do not seek conferences with teachers during school hours. If you wish a conference, please make an appointment to see the teacher after school. Teachers are available for such conferences every day except Wednesdays and Fridays.

Bicycles

NO bicycles are allowed at either Forest Road or Clear Stream Avenue Schools because no child lives far enough from the school to make them necessary. They are allowed at Shaw, but are restricted to pupils in grades 4, 5, and 6 who live NORTH OF FOSTER AVENUE. Bicycle operators must wear safety helmets. All must have a lock and chain for safety purposes.

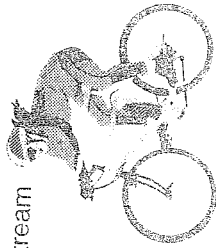

Gifts to Teachers Prohibited

The policy of the school district which became effective January 1956, is to prohibit the acceptance of gifts by faculty members on school premises, and to prohibit the solicitation of funds for personal gifts purposes, by any person, or persons, on the premises.

In-Day Program

In inclement weather, there is an in-day program of motion pictures or quiet games provided for those pupils who eat in the cafeteria. Pupils who go home to do their homework are allowed to participate in this program because of space limitations, as are only parents to return these pupils to school on such days just in time for the afternoon session - not before five minutes prior to their scheduled lunch time.

Assignment Requirements

Classroom learning is improved through effective homework assignments. Homework may include review, reinforcement, reading in preparation for classroom discussion, analysis and research. Homework helps students establish



work habits which will influence their use of time throughout life. Homework is required of all pupils, but it will vary from day to day. First and second grade pupils may have fifteen to twenty minutes of homework per day, while third and fourth grade pupils are likely to have thirty to forty minutes. Fifth and sixth graders are expected to devote as much as an hour to homework. Students should require little if any help from parents in completing assignments.

However, parents may assist students by insuring that they have a quiet, comfortable place to work.

Lost and Found

Unmarked articles lost by pupils are placed in the Lost-and-Found, which is in the Nurse's Office at Clear Stream, Shaw and Forest. Such articles, if not claimed at the end of the school year, are given to a charitable organization. However, any article bearing a child's name is returned directly to him/her. Please place your child's name on all his/her belongings.

Assemblies

When your child's class puts on an assembly program, we welcome your attendance, but we do ask you not to bring pre-school children. As much as we realize that it is a thrill for them to see older siblings perform, they are often distracting to all concerned. Picture taking or video taping are not allowed without prior approval.

Medication

When it is necessary for the child to take internal medication during school hours, the nurse will cooperate with the family physician and the parents. The parent must submit a written request to the Nurse with a written request from the family physician indicating the frequency and dosage of a prescribed medication. Then the school nurse will administer this medication during the school hours. Under no circumstances will a child be permitted to carry or to take medication by himself or herself.

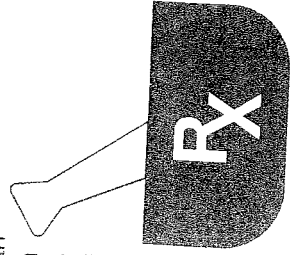

Vandalism

Vandalism costs money. Help us to reduce this drain on our tax dollars by keeping a watchful eye on your local school. Perhaps you have noticed persons on school grounds who were behaving suspiciously or actually engaged in vandalism, but you have not known where to call.

To report school vandalism or suspicious activities at your school, call the Nassau County Emergency Number 911. Give the name of the school, its location, and a brief description of what is happening. A police car will be radio-dispatched to investigate, and appropriate school personnel will be alerted. School officials will prosecute offenders whenever possible and attempt to secure restitution for damages.

	5/1/76

Please report any of these activities:

- persons on the roof of the school
- anyone throwing objects at windows
- someone shooting weapons of any kind
- any kind of fire on school grounds
- destruction of grounds, shrubbery, or facility
- anyone operating mini-bikes on playgrounds or driveway
- any other suspicious or criminal acts

Use of School Facilities

Parents and other community members are invited to use school facilities for community purposes when such use does not interfere with the scheduled school activities. Requests for the use of school facilities should request an "Application for the Use of School Facilities" form from the principal and be accompanied by other administrative rules and a statement of costs are explained on the application form.

School Visits

Parents and other community members are invited to visit school to meet the members of the professional staff, to examine the facilities, and instructional programs, and to observe classes. Those wishing to observe classes or to meet with staff members should arrange the visit in advance so that the time is appropriate and does not interfere with planned activities.

Parents must register at the school office upon arrival, before visiting other parts of the building.

At dismissal times, parents picking up students are requested to meet them at a previously designated spot outside of the school. Dismissal will be held only in the assigned classroom. Students are expected to leave the school building and school property in an orderly fashion at dismissal time each day. Such procedures are necessary to insure the safety of all students.

School Closings or Delayed Openings

Weather and other emergencies may warrant school closings or delayed openings. A delayed opening means students are expected to be at school at 10 AM. PTA Class Parents will be informed and will initiate telephone calls to inform parents of such a class. NEWS 12 on Channel 12 will carry school closing information. Such school closings or delays will be also announced on the following local radio stations:

WCBS (AM) 88
WGBB (AM) 1240
WGSB (AM) 740

WHLI (AM) 1100
WINS (AM) 1010
WALK (FM) 97.5

WALK (AM) 1370



School Telephone Directory

Main Office: Washington Avenue School	285-9881
Superintendent	285-9880
Business Office	285-9833
Curriculum Office	285-9839
FAX	
Clear Stream Avenue School	
Principal's Office	872-4333
Nurse's Office	872-4336
Forest Road School	
Principal's Office	791-6134
Nurse's Office	791-6790
Shaw Avenue School	
Principal's Office	872-4320
Nurse's Office	872-4327
Special Services	
Computer Coordinator/AV Consultant	872-4342
Committee for Special Education	
Chairperson	
Sp. Ed. Parent Reps. Mrs. Lefcort	285-9820
Mrs. Vardakis	791-3729
	791-7285

Board of Education	Page 2
District Staff	Page 4
Special Services and Programs	Page 5
General Information	Page 6
Weather Closings	Page 6
School Policies	Pages 7 & 8
Clear Stream PTA	Page 9
Forest Road PTA	Page 10
Shaw Avenue PTA	Page 11
Monthly Calendars	Pages 12 - 23
Valley Stream Council of PTA's & SEPTA	Page 22

Valley Stream High School District
 Central High School 561-4400
 Memorial Junior High School 872-7700
 North High School 564-5500
 South High School 791-0300

Valley Stream School District No. 30 and Valley Stream Central High School District Valley Stream, New York

District No. 30 Schools
 Shaw Avenue A
 Clear Stream Avenue B
 Forest Road C
 Washington Avenue D
 (District Office)

High Schools
 North High
 Memorial Jr. High
 Central High
 South High

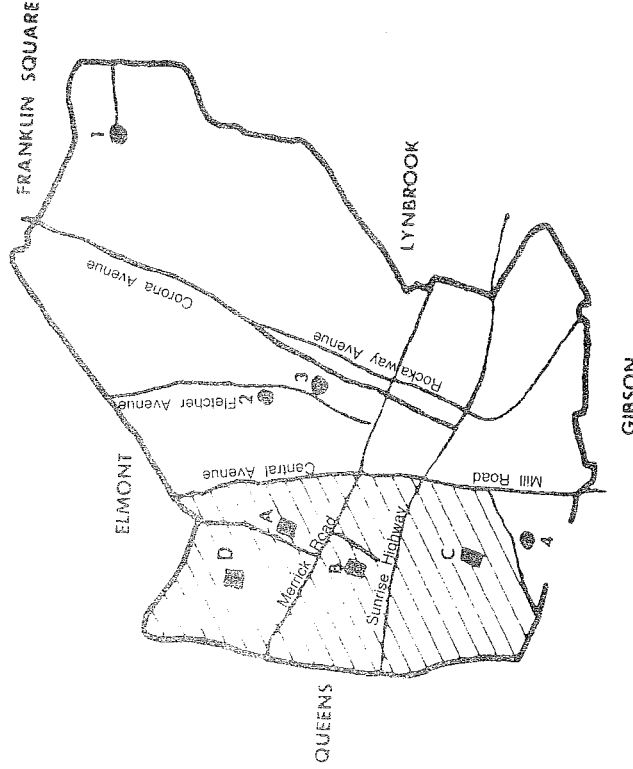

Calendar Preparation:
 Dr. Barbara Warren Cronin
 Angela Nicolini

Cover Design:
 Kevin Smith, Forest Road School

School Administration

Dr. Charles W. Fowler, District Superintendent

Lawrence R. McGoldrick
Superintendent of Schools

David Kutcher
Assistant Superintendent

Dee Wyllray
Assistant to the Superintendent

Michael Fallicko

Dr. J. Giovanni Avenue School
Dr. Robert A. Cohen

Forest Road School
Dr. Barbara Warren Cronin

Shaw Avenue School
Mr. Stanley Kaminsky

Director of Facilities
Gregory Abbate

Secretary to Superintendent
Madeline Furst

School Secretaries

Lucia Imbriani, Clear Stream Avenue

Janet Scollari, Forest Road

Ann Borsello, Shaw Avenue

Shaw Avenue School

Valerie Barcheski

Nancy Bart

Lois Benedetto

Laure Graziano

Ann Fischer

Ann Marie Homer

Joanne Lufrano

Tina O'Shea

Elizabeth Shaw

Building Level Teams

Clear Stream Avenue School

Mr. Robert A. Cohen
Sandra Aragona
Karen Catalanotto
Barbara Clarke
Faye Marino
Julie McCain
Mary Sheffield
Joanne Spagno
Parent TBD

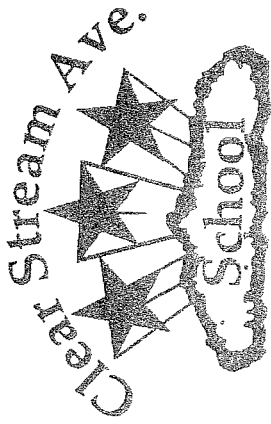

Forest Road School

Dr. Barbara Warren Cronin
Arlene Drimal
Bonnie Epstein
Ellyn Fitzgerald
Elaine Friedman
Linda Kettering
Jill Mandel
Allison Needleman
Dennis Terrell
Carol Tolle



Shaw Avenue School

Mr. Stanley Kaminsky
Valerie Barcheski
Nancy Bart
Lois Benedetto
Laure Graziano
Ann Fischer
Ann Marie Homer
Joanne Lufrano
Tina O'Shea
Elizabeth Shaw

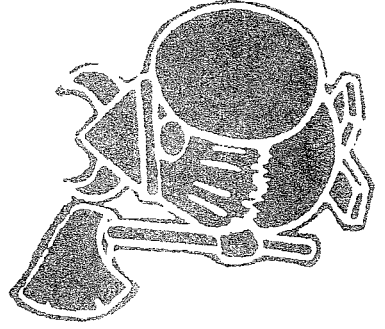

Alyce Gardner,
Clear Stream Avenue

Sue Lombardo,
Shaw Avenue

JUNE 1998

Su	M	Tu	W	Th	F	Sa
3	4	5	6	7	8	9
10	11	12	13	14	15	16
17	18	19	20	21	22	23
24	25	26	27	28	29	30
31						

Su	M	Tu	W	Th	F	Sa
5	6	7	8	9	10	11
12	13	14	15	16	17	18
19	20	21	22	23	24	25
26	27	28	29	30	31	

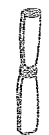
SUNDAY	MONDAY	TUESDAY	WEDNESDAY	THURSDAY	FRIDAY	SATURDAY	
1 Forest Field Day	2 V.S. PTA Council Mtg./Installation 7:30 P.M. North H.S.	3 Clear Stream/Forest Banking	4 Clear Stream PTA Mtg. 9 A.M.	5 Forest PTA Staff Luncheon	6 Shaw School Spirit Day		
7 V.S. SEPTA Mtg. Mem. JHS 8 P.M.	8 Clear Stream/Forest Banking	9 Shaw PTA Social Mtg. 8 P.M.	10 Clear Stream PTA Installation Dinner 7 P.M.	11 Clear Stream/Shaw Father's Day Boutique 9 A.M. - 2:30 P.M.	12 Forest PTA Volunteer Appreciation Brunch	13 Shaw Girls Escort Dance 7:30 - 10 P.M.	
14 FLAG DAY	15 Forest Field Day	16 Shaw Field Day	17 Forest Field Day (Raindate)	18 Clear Stream Father's Day Boutique 9 - 2:30 P.M. Forest PTA Book Fair 9 - 2:30 P.M.	19 Forest PTA Book Fair 9 A.M. - 2:30 P.M.	20 Shaw Family Yard Sale 10 A.M. - 3 P.M.	
21 Father's Day	22 V.S. SEPTA Mtg. Mem. JHS 8 P.M.	23 Shaw Field Day	24 CLEAR STREAM/FOREST/SHAW 6th Gr. Closing Exercises 8:15 P.M.	25 CLEAR STREAM/FOREST Kindergarten Graduation 9 A.M. Clear Stream/Forest/Shaw 6th Gr. Parties 1 - 3 P.M.	26 SHAW Kindergarten Graduation 8:30 A.M. Last Day of School 8:30 - 9:30 A.M.	27 Shaw Yard Sale (Raindate)	
28	29 Dist. Bd. of Ed. Comm. Mtg. 8 P.M.	30 Dist. Bd. of Ed. Mtg. 8 P.M.	 <i>Congratulations Graduates</i> 				SHADED BOX INDICATES SCHOOL IS CLOSED

SEPTA

Valley Stream Officers for 1997-1998

- Co-President: Gregory Ferraro 887-9384
- Vice Presidents: Joanna Ortiz 285-1567
Robert Musmacher 568-9604
- Hon. Vice Pres. Dr. Martin Brooks
- Treasurer: Rosemary Rader 872-8669
- Rec. Secretary: Rose Barbaro 561-8018
- Correspond. Secty.: Lorraine Radice 825-0667
- Delegate to Council: Trish Rakow 887-7278
- Delegate to SEPTA/BOCES: Josephine Santori 485-6411
- Past Presidents: Pat McCormick 285-8618
Kathy Russo 872-9393

Valley Stream Council of PTA's Elected Officers

- President: Ann Marie Costiglio 791-1799
- First V. Pres. Cathy Rotkowitz 599-1637
- Scholarship: Patti Schwartz 791-1346
- Treasurer: Carol Jakubowski 872-6306
- Rec. Secretary: Lorraine Marino 596-1827
- Correspond. Secty.: Anne Winn 825-5768
- Past President:

JULY 1998						
SUNDAY	MONDAY	TUESDAY	WEDNESDAY	THURSDAY	FRIDAY	SATURDAY
1	2	3	4	5	6	7
8	9	10	11	12	13	14
15	16	17	18	19	20	21
22	23	24	25	26	27	28
29	30	31				

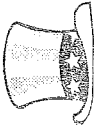

 Out of Ed. (Education & Business) Mag 7:30 P.M.

SHAIRED BOX INDICATES SCHOOL IS CLOSED

AUGUST 1998						
SUNDAY	MONDAY	TUESDAY	WEDNESDAY	THURSDAY	FRIDAY	SATURDAY
1	2	3	4	5	6	7
8	9	10	11	12	13	14
15	16	17	18	19	20	21
22	23	24	25	26	27	28
29	30	31				



 V-SCHISD (Ed. & Bus. Mag) 8:30 P.M.

SHAIRED BOX INDICATES SCHOOL IS CLOSED

APRIL 1998

Su	Mo	Tu	We	Th	F	Sa
1	2	3	4	5	6	7
8	9	10	11	12	13	14
15	16	17	18	19	20	21
22	23	24	25	26	27	28
29	30	31				

Su	Mo	Tu	We	Th	F	Sa
3	4	5	6	7	8	9
10	11	12	13	14	15	16
17	18	19	20	21	22	23
24	25	26	27	28	29	30
31						

MONDAY	TUESDAY	WEDNESDAY	THURSDAY	FRIDAY	SATURDAY
		1 Clear Stream PTA Exec. & Gen. Mtg. 6:45 P.M.	2 Forest Pre-K Mtg. 3 P.M.	3 Clear Stream Spring Melodies 7:30 P.M.	4
	7 Clear Stream/Forest Banking Shaw Banking Gr. K-2 Forest PTA Exec. Bd. Mtg. 8:30 A.M. Shaw PTA Mtg. Chnl. Mtg. 8 P.M. Parent Spring Concert 7:30 P.M. VSCHSD Bd. of Ed. Comm. Mtg. 8:30 P.M.	8 Shaw Spring Concert 7:30 P.M.	9 Schools Closed	10 Schools Closed	11
14 Schools Closed	15 Schools Closed	16 Earth Day	17 Shaw Kids' Fun Day 10 A.M. - 2 P.M.	18	
20 GRADUATION REGISTRATION At Schools 9 - 11 A.M. Deadline for Filing Petitions for Trustee 5 P.M. V.S. SEPTA Mtg. Mon. JHS 3 P.M. Dist. 30 Bd. of Ed. Comm. Mtg. 6 P.M.	21 Clear Stream/Forest Banking Shaw Banking Gr. K - 2	22 Earth Day	23 Shaw Banking Gr. 3-6 LC II	24 Clear Stream Kids' Night Out 7:30 P.M.	25
26 Clear Stream/Forest Banking VSCHSD Annual Mtg. 7 P.M. BOCES BUDGET VOTE 8 P.M. w/Dist. 30 Bd. of Ed. Mtg. following.	27 Clear Stream/Forest Banking VSCHSD Bd. of Ed. Mtg. 8 P.M.	28 Forest PTA Gen. Mtg. 7:30 P.M. Forest Spring Boutique 8 P.M.	29 Clear Stream Staff Recognition	30 Clear Stream Staff Recognition	SHADED BOX INDICATES SCHOOL IS CLOSED

MAY 1998

April

Su	M	Tu	W	Th	F	Sa
5	6	7	8	9	10	11
12	13	14	15	16	17	18
19	20	21	22	23	24	25
26	27	28	29	30		

June

Su	M	Tu	W	Th	F	Sa
7	8	9	10	11	12	13
14	15	16	17	18	19	20
21	22	23	24	25	26	27
28	29	30				

SUNDAY	MONDAY	TUESDAY	WEDNESDAY	THURSDAY	FRIDAY	SATURDAY
3	4	5	6	7	8	9
10	11	12	13	14	15	16
17	18	19	20	21	22	23
24	25	26	27	28	29	30
31						

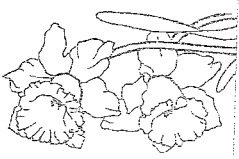
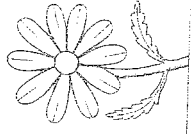
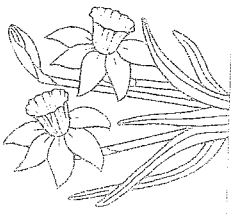

Shaw Totis to Teens' Show
Central H.S. Auditorium, 7:30 P.M.

Clear Stream Mother's Day
Plant Sale

Forest Plant Sale

Shaw Boys Escort Dance
7:30 P.M. - 10 P.M.

N.Y.S. PEP Gr. 5
Writing Test 9:15 A.M.
Shaw Mother's Day Boutique
9 A.M. - 2:30 P.M.

Forest Plant Sale
Shaw Banking Ends
Gr. 3 - 6 & LC II

Clear Stream PTA Exec.
& Gen. Mtg. 6:45 P.M.
Budget Hearing (Dist. 24)
8:15 P.M. W.L. Buck

N.Y.S. PEP Gr. 3 & 6
Reading Test 9:15 A.M.

Forest Plant Sale/Pre-Order
Pick-up 11 A.M.

Budget Hearing (Dist. 30)
8 P.M. Clear Stream

N.Y.S. PEP Gr. 3 & 6
Math. Test 9:15 A.M.

N.Y.S. PEP Gr. 5
Writing Test 9:15 A.M.
Clear Stream/Forest Banking
Shaw Banking Ends Gr. K - 2
Mtg. 8:30 A.M.

Budget Hearings (Dist. 13)
8 P.M. Dever

Shaw PTA Mtg. &
Volunteer Night 8 P.M.

12 Voter Registration
7 - 9 A.M. & 4 - 9 P.M.
All Schools

Clear Stream/Forest
Banking

Clear Stream/Forest
Pre-School Mtg. 7:30 P.M.
VSCHSD Bd. of Ed.
Mtg. 8:30 P.M.

19 VOTING
Dists. 13 & 30
7 A.M. - 10 PM
Dist. 24

7 A.M. - 9 P.M.

DISTRICT ART EXHIBIT
7:30 P.M. - 9 P.M.

VSCHSD Bd. of Ed.
Comm. Mtg. 8 P.M.

District 30 Music Festival
7:30 P.M.
prior to

District 30 Bd. of Ed.
Mtg. 8 P.M.

MEMORIAL DAY
(Schools Closed)
Memorial Day Parade
8 A.M.



Shaw PTA Installation
Dinner

Forest PTA Installation
Dinner

FEBRUARY 1998

J	F	Sa
Su	M	Tu
4	5	6
11	12	13
18	19	20
25	26	27
1	2	3
8	9	10
15	16	17
22	23	24
29	30	31

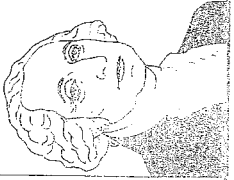
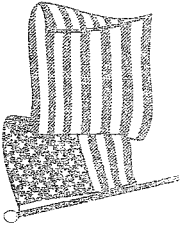
M	Th	F	Sa
Su	M	Tu	W
1	2	3	4
8	9	10	11
15	16	17	18
22	23	24	25
29	30	31	

SUNDAY	MONDAY	TUESDAY	WEDNESDAY	THURSDAY	FRIDAY	SATURDAY
1	2 V.S. PTA Council Mtg. 7:30 P.M., Willow Road	3 Clear Stream/Forest Banking Shaw Banking Gr. K - 2 VSCHSD Bd. of Ed. Comm. Mtg. 8 P.M.	4 Clear Stream PTA Mtg. 9 A.M. Clear Stream Cupcake Sale 1:30 P.M. Forest PAPP P.J. Party	5 Shaw Banking Gr. 3 - 6 & LC II	6 Clear Stream PARP ends Clear Stream Parent-Child Night 7 P.M.	7 VSCHSD Budget Review
8	9 Shaw Candy Sale Begins V.S. SEPTA Mtg. Mem. JHS 8 P.M. Dist. 30 Bd. of Ed. Comm. Mtg. 8 P.M.	10 Clear Stream/Forest Banking Forest PTA Exec. Bd. Mtg. 8:30 A.M. Shaw PTA Mtg. 8 P.M. Forest PARP Ends VSCHSD Bd. of Ed. Mtg. 8:30 P.M.	11 PTA FOUNDERS DAY at FOREST ROAD 7:30 P.M.	12 LINCOLN'S BIRTHDAY	13	14
15	16 Schools Closed	17	18	19	20	21
22 WASHINGTON'S BIRTHDAY	23 Shaw Candy Sale Ends Dist. 30 Bd. of Ed. Mtg. 8 P.M.	24 Clear Stream/Forest Banking Shaw Banking Gr. K-2	25	26 Shaw Banking Gr. 3 - 6 & LC II	27	28
						SHADED BOX INDICATES SCHOOL IS CLOSED

MARCH 1998

February

Su	M	Tu	W	Th	F	Sa
1	2	3	4	5	6	7
8	9	10	11	12	13	14
15	16	17	18	19	20	21
22	23	24	25	26	27	28

April

Su	M	Tu	W	Th	F	Sa
5	6	7	8	9	10	11
12	13	14	15	16	17	18
19	20	21	22	23	24	25
26	27	28	29	30		

SUNDAY	MONDAY	TUESDAY	WEDNESDAY	THURSDAY	FRIDAY	SATURDAY
1	2 Shaw PARP Begins	3 Forest PTA Exec. Bd. Mtg. 8:30 A.M. Clear Stream/Forest Banking	4 Clear Stream PTA Exec. & Gen. Mtg. 6:45 P.M.	5 Shaw Banking Gr. 3-6 LC II	6 Shaw No Twirl	7 Forest PTA Carnival 11 A.M. - 3 P.M.
8	9 Shaw No Dance	10 Clear Stream/Forest Banking Shaw Banking Gr. K - 2 Shaw PTA Mtg. 8 P.M.	11 Clear Stream/Forest Banking	12 Clear Stream Fashion Show, 7 P.M.	13 Shaw No Twirl	14 Forest PTA Carnival 11 A.M. - 3 P.M.
15	16 V.S. SEPTA Mtg. Mem. JHS 8 P.M.	17 Clear Stream/Forest Banking	18 Clear Stream Pre-School Mtg. 1:30 P.M.	19 Clear Stream Fashion Show, 7 P.M.	20 Breakfast w/Supt. Shaw 8:30 A.M.	21 PTA Council Legislature Breakfast 9:30-11:30 A.M. Mem. Cafe B
22	23 Dist. 20 Bd. of Ed. Comm. Mtg. 8 P.M.	24 Clear Stream/Forest Banking	25 Forest PTA Mtg. 8 P.M.	26 Shaw Banking Gr. 3-6 LC II	27 Shaw Banking Gr. 3-6 LC II	28 Shaw Moonlight Bowl
29	30 Dist. 30 Bd. of Ed. Mtg. 8 P.M.	31 Clear Stream/Forest Banking Shaw T-Shirt Sale 2:45 P.M.				

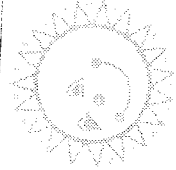



SP 16

SHADED BOX INDICATES SCHOOL IS CLOSED

DECEMBER 1997

Su	1	2	3	4	5	6	7	8
Mo	9	10	11	12	13	14	15	16
Tu	17	18	19	20	21	22	23	24
We	25	26	27	28	29	30	31	

Ja	1	2	3
Feb	4	5	6
Mar	7	8	9
Apr	10	11	12
May	13	14	15
Jun	16	17	18
Jul	19	20	21
Aug	22	23	24
Sep	25	26	27
Oct	28	29	30
Nov	31		

SUNDAY	MONDAY	TUESDAY	WEDNESDAY	THURSDAY	FRIDAY	SATURDAY
7 	8 V.S. PTA Council Mtg. 7:30 P.M. Dever	9 Clear Stream/Forest Banking Shaw Banking Gr. K - 2 Nassau Dist. PTA Presidents/Principals Dinner Forest PTA Exec. Bd. Mtg. 8:30 A.M. Clear Stream/Forest Banking VSCHSD Bd. of Ed. 8:30 P.M.	10 Clear Stream PTA Mtg. 9 A.M. VSCHSD Bd. of Ed. Comm. Mtg. 8 P.M.	11 Forest Holiday Boutique 9 A.M. - 2:30 P.M. Shaw Banking Gr. 3 - 6 & LC II Clear Stream/Shaw Holiday Boutique 9 - 2:30 P.M.	12 Forest Holiday Boutique 9 A.M. - 2:30 P.M. Shaw No Twirl Clear Stream Winter Melodies 7:30 P.M.	13 VSCHSD Building Tour Clear Stream Breakfast w/Santa 10 AM - 12 PM Shaw Breakfast w/Santa 9 - 11 A.M.
14	15 Dist. 30 Bd. of Ed. Mtg. 8 P.M.	16 Clear Stream/Forest Banking Shaw Banking Gr. K - 2 Forest Winter Concert 7:30 P.M.	17 Shaw Winter Concert 7:30 P.M.	18 Shaw Banking Gr. 3 - 6 & LC II	19	20
21	22 Schedule Closed	23 Schedule Closed	24	25 	26	27
28	29 Schedule Closed	30	31			

SHADED BOX INDICATES SCHOOL IS CLOSED



OCTOBER 1997

Su	1	2	3	4	5	6
7	8	9	10	11	12	13
14	15	16	17	18	19	20
21	22	23	24	25	26	27
28	29	30				

Su	M	Tu	W	Th	F	Sa
1	2	3	4	5	6	7
8	9	10	11	12	13	14
15	16	17	18	19	20	21
22	23	24	25	26	27	28
29	30					

SUN	MONDAY	TUESDAY	WEDNESDAY	THURSDAY	FRIDAY	SATURDAY
5	6 Shaw Grade 6 Outdoor Education Program Shaw Gift Wrap Ends V.S. PTA Council Mtg. 7:30 P.M. at Forest	7 Clear Stream Banking Forest PTA Exec. Bd. Mtg. 8:30 A.M. Shaw PTA Mtg. 8 P.M. Forest Candy Sale Ends VSCHSD Bd. of Ed. Comm. Mtg. 8 P.M.	8 Clear Stream PTA Mtg. 9 A.M.	9 Clear Stream School Pictures	10 Clear Stream Candy Sale Begins	11
12	13 COLUMBUS DAY Schools Closed	14 Shaw Banking Reg. Begins Forest Road Banking VSCHSD Bd. of Ed. Mtg. 8:30 P.M.	15 Clear Stream Gr. 6 Outdoor Ed. Program Shaw Fingerprinting Forest PTA Mtg. 9 A.M.	16	17 Breakfast w/Supt. Forest 8:30 A.M.	18
19	20 Clear Stream Gr. 6 Outdoor Ed. Program Clear Stream Reflections Begins Shaw Dance Begins VS SEPTA Mtg. Mem JHS 8 P.M. Dist. 30 Bd. of Ed. Comm. Mtg. 8 P.M.	21 Clear Stream/Forest Gr. 6 Outdoor Ed. Program Clear Stream/Forest Banking Clear Stream Pumpkin Patch, All Day	22 Forest Gr. 6 Outdoor Ed. Program	23 Forest Gr. 6 Outdoor Ed. Program	24 Clear Stream Candy Sale Ends Shaw Pumpkin Patch Shaw Twirling Begins	25
26	27 Dist. 30 Bd. of Ed. Mtg. 8 P.M.	28 Clear Stream/Forest Banking Shaw Banking Reg. Ends	29 Clear Stream Reflections End	30 Clear Stream Reflections End	31 HALLOWEEN Clear Stream 5th & 6th Gr. Halloween Party 5:30 - 7:30 P.M.	SHADED BOX INDICATES SCHOOL IS CLOSED



NOVEMBER 1997

December

Su	M	Tu	W	Th	F	Sa
1	2	3	4	5	6	
7	8	9	10	11	12	13
14	15	16	17	18	19	20
21	22	23	24	25	26	27
28	29	30	31			

October

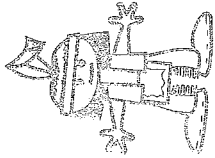
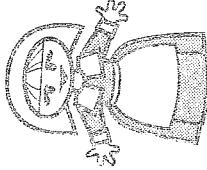
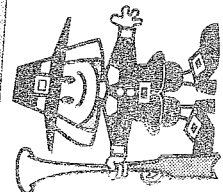
Su	M	Tu	W	Th	F	Sa
5	6	7	8	9	10	11
12	13	14	15	16	17	18
19	20	21	22	23	24	25
26	27	28	29	30	31	

SUNDAY	MONDAY	TUESDAY	WEDNESDAY	THURSDAY	FRIDAY	SATURDAY
2 SHADED BOX INDICATES SCHOOL IS CLOSED	3 	4 	5 	6 	7 VSUFSD #30 Bldg. inspection	8
9	10 Shaw PTA Mtg. 8 P.M. Forest PTA Exec. Bd. Mtg. 8:30 A.M.	11 ELECTION DAY 6 A.M. - 9 P.M. FOREST/SHAW Superintendent's Conference Day (No School for Students) VSCHSD Bd. of Ed. Comm. Mtg. 8 P.M.	12 Clear Stream PTA Exec. & Gen. Mtg. 6:45 P.M.	13 Shaw Book Fair 8:30 A.M. - 2:30 P.M. Shaw Banking Gr. 3-6 & LC II	14 Shaw Breakfast/w Santa ticket sale 2:45 - 3 P.M.	15
16	17 V.S. SEPTA Mtg. Mem. JHS 8 P.M.	18 American Education Week	19 VSCHSD Bd. of Ed. Mtg. 9:30 P.M.	20 Clear Stream Picture Retake	21 Clear Stream Reflections Night 7 P.M.	22
23	24 Dist. 30 Bd. of Ed. Comm. Mtg. 8 P.M.	25 Clear Stream/Forest Banking Shaw Banking Gr. K - 2	26 Clear Stream Book Fair all day Clear Stream Pre-school Mtg. 1:30 P.M. Forest PTA Mtg. 8 P.M.	27 Clear Stream Book Fair Morning only Shaw Banking Gr. 3-6 LC II	28 Schools Closed	29
30 Dist. 30 Bd. of Ed. Mtg. 3 P.M.	31	28 Forest Thanksgiving Breakfast Shaw Picture Retake Day	29 Forest Thanksgiving Breakfast Shaw Picture Retake Day	30 THANKSGIVING DAY Schools Closed	31 Schools Closed	



SEPTEMBER 1998



October

Su	M	Tu	W	Th	F	Sa
4	5	6	7	8	9	10
11	12	13	14	15	16	17
18	19	20	21	22	23	24
25	26	27	28	29	30	31

Su	M	Tu	W	Th	F	Sa
2	3	4	5	6	7	8
9	10	11	12	13	14	15
16	17	18	19	20	21	22
23	24	25	26	27	28	29
30	31					

SUNDAY	MONDAY	TUESDAY	WEDNESDAY	THURSDAY	FRIDAY	SATURDAY
		1	2	3	4	5
6	7 LABOR DAY	8 Supt's. Conferences Day for Staff (Tentative) No school for students (Tentative)	9 Schools Open (Tentative)	10	11	12
13	14	15	16	17	18	19
20	21	22	23	24	25	26
27	28	29	30			

Printed by the Instructional Services Center
Valley Stream Central High School District

Valley Stream District 30 1998 - 1999

Math Message:

1. do pages
41 - 42

$$\begin{array}{r}
 23 \\
 \times 4 \\
 \hline
 92
 \end{array}$$

✓ check

$$\begin{array}{r}
 23 \\
 4 \overline{)92}
 \end{array}$$

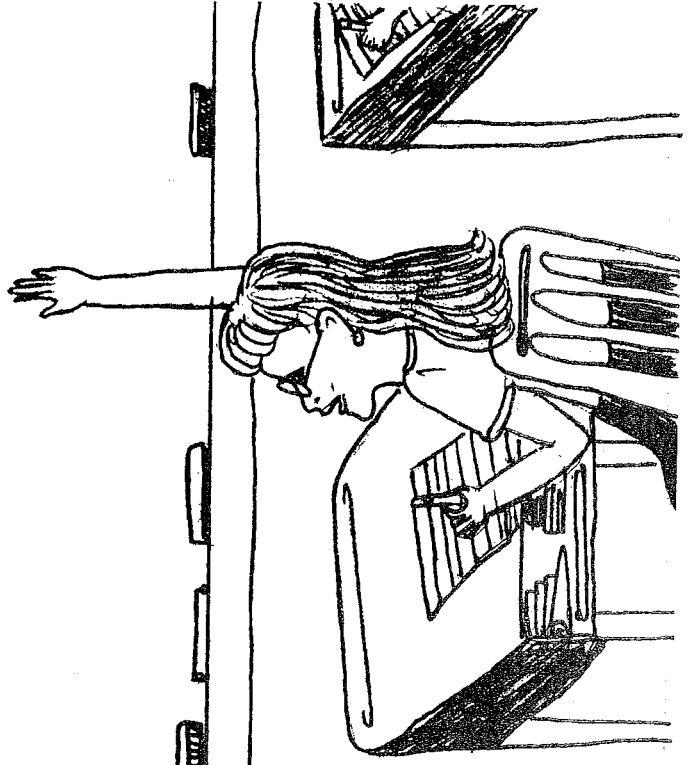
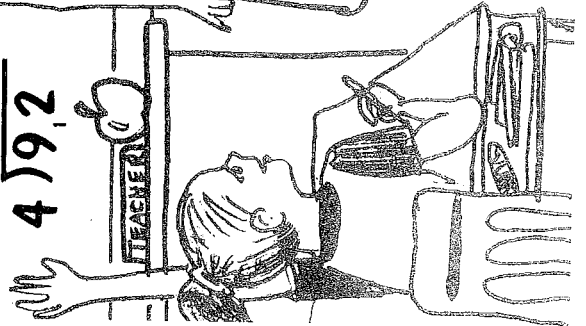
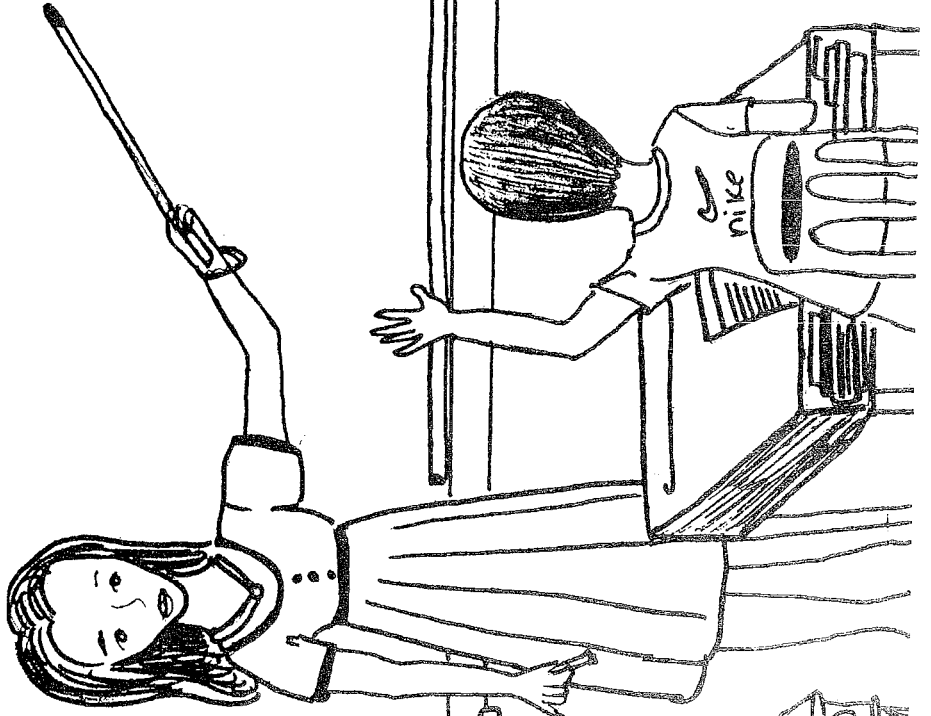

Board of Education

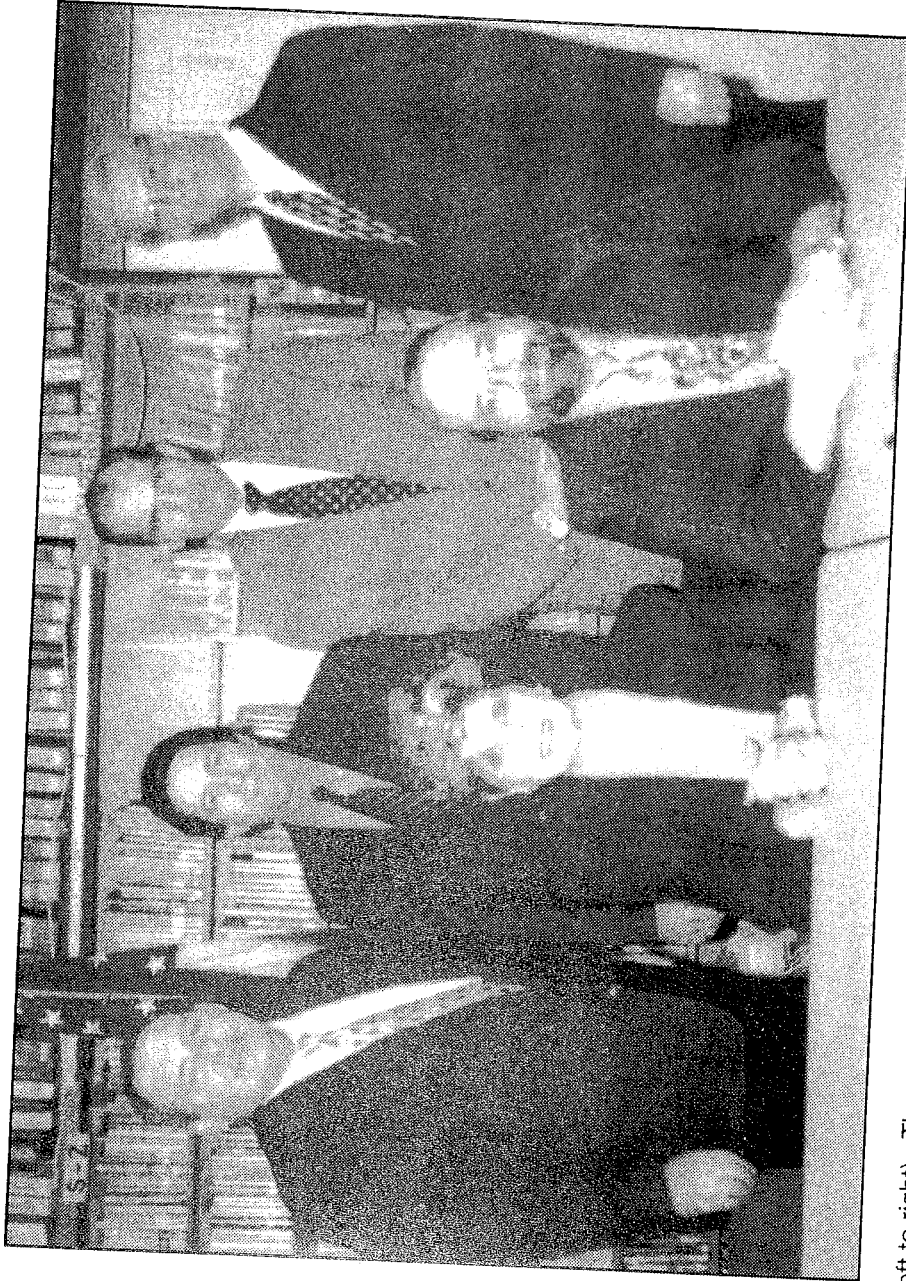

Standing (left to right): Thomas Galgano, Trustee; * Richard Eisenberg, Vice President;
Lawrence R. McGoldrick, Superintendent of Schools; William Gauger Trustee
Seated (left to right): * Leanore Egan, President; * Andrew Walters, Trustee

*Also serves on the High School Board

SHAW AVENUE PARENT TEACHER ASSOCIATION 1998-1999

POSITION	ELECTED OFFICERS	TELEPHONE NO.	POSITION	ELECTED OFFICERS	TELEPHONE NO.
President	Kathy Vagnone	825-3849	Holiday Boutique	Tammy Deto	285-7034
1st Vice President	Vivian Rainone	872-1132	Hospitality	Genine Iadevaio	285-7471
2nd Vice President	Debbie Dolan	285-7483	Installation Dinner	Debbie Walsh	561-1387
Honorary VP	Henry Mazer	Faculty	Jr. Bowling	MaryAnn Antoniato	285-4652
Treasurer	Marybeth Cully	825-2935	Ladies Volleyball (Tues.)	Michael Antoniato	285-4652
Financial Secretary	Tara Starna	561-3613	Labels for Education	Tom Bannon	285-6620
Recording Secretary	Rosann Colucci	561-3602	Membership	Lorraine Brooks	561-1902
Corresponding Secretary	Mary Berman	568-1479	Mothers Day Boutique	Mary Berman	568-1479
Delegates to Council	Mary Aumeller	285-0439	New Parents Tea	Dolores Jacobson	568-9894
Teacher Delegate	Marianne Estevez	285-3743	Newsletter	Mary Berman	568-1479
	Dennis Carr	Faculty		Dolores Jacobson	568-9894
				PTA EXECUTIVE BOARD	
COMMITTEE CHAIRPERSONS					
Arts in Education	Paul Farinacci	872-4320		Rosann Colucci	561-3602
Banking	Judy Post	872-4320		Tara Starna	561-3613
Birthday Calendar	PTA EXECUTIVE BOARD			Karen DePalma	285-8959
Book Fair	Eileen Brady	872-0415		Joyce Galante	285-6302
Breakfast w/Santa	Tara Starna	561-3613		Delores Jacobson	568-9894
Cupcake Sale	PTA EXECUTIVE BOARD			Delores Jacobson	568-9894
Dance & Twirl Info.	Rosann Colucci	561-3602		Diane Velsor	285-6162
Dance & Twirl Reg.	Joanne Zdanko	568-0498		Rosann Colucci	561-3602
Father's Day Boutique	Fran Buccola	561-2357		Marianne Estevez	285-3743
Field Day/Play Day	Tracey Blanchflower	285-7190		PTA EXECUTIVE BOARD	
Field Day/Play T Shirts	Linda Roach	561-1423		Chris Vessely	285-5736
Fingerprinting	Genine Iadevaio	285-7471		Vivian Rainone	872-1132
Fun Fair	Marybeth Cully	825-2935		Chris Busapavanij	285-5036
Gift Wrap Sale	Rose Stroehlein	568-1522		Ginny Gregory	825-2291
Grade Rep. Coordinator	Linda Roach	561-1423		PTA EXECUTIVE BOARD	
	PTA EXECUTIVE BOARD			Marybeth Cully	825-2935
	PTA EXECUTIVE BOARD			Rose Stroehlein	568-1522
	Vivian Rainone	872-1132		Vivian Rainone	872-1132

August

Su	M	Tu	W	Th	F	Sa
2	3	4	5	6	7	3
9	10	11	12	13	14	15
16	17	18	19	20	21	22
23	24	25	26	27	28	29
30	31					

SEPTEMBER 1998

Su	M	Tu	W	Th	F	Sa
4	5	6	7	8	9	10
11	12	13	14	15	16	17
18	19	20	21	22	23	24
25	26	27	28	29	30	31

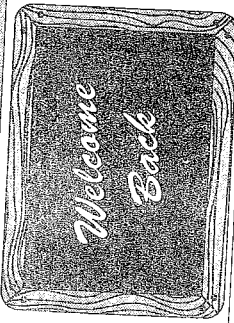
SUNDAY	MONDAY	TUESDAY	WEDNESDAY	THURSDAY	FRIDAY	SATURDAY
<p>1</p> 	<p>2</p> <p>Supt. Conference Day No School for Students</p>	<p>3</p> <p>Schools Open Clear Stream Coffee, Tea & Tears for Kindergarten Parents 8:30 a.m.</p>	<p>4</p>	<p>5</p>	<p>6</p>	<p>7</p>
<p>8</p> <p>LABOR DAY Schools Closed</p>	<p>9</p> <p>Forest Exec. Bd Mtg. 8:30 a.m.</p> <p>Clear Stream Class Parent Mtg. 7:30 p.m.</p> <p>VSCHSD Bd. of Ed. Mtg. 8:30 p.m.</p>	<p>10</p> <p>Supt. Conference Day No School for Students</p> <p>VSCHSD Bd. of Ed. Comm. Mtg. 8 P.M.</p>	<p>11</p> <p>Shaw Bowling Registration 2:45 p.m.</p> <p>CLEAR STREAM/ FOREST/SHAW Meet the Teacher Night 7:30 p.m.</p>	<p>12</p> <p>Forest PTA New Parent's Tea 8:30 a.m.</p> <p>Shaw PTA New Parent's Tea 8:30 - 11:00 a.m.</p>	<p>13</p>	<p>14</p>
<p>15</p> <p>PRIMARY ELECTION 6 a.m.-9 p.m. Forest/Shaw (Schools in session)</p> <p>Shaw PTA Gen. Mtg. 8 p.m.</p>	<p>16</p> <p>Clear Stream Fingerprinting 9 a.m. - 11 a.m. Forest PTA Class Parent Mtg. 7:30 p.m. & Gen. Mtg. 8 p.m. Clear Stream Parents Get Together 7 p.m. & PTA Gen. Mtg. 8 p.m.</p>	<p>17</p> <p>Clear Stream Fingerprinting 9 a.m. - 11 a.m. Forest PTA Class Parent Mtg. 7:30 p.m. & Gen. Mtg. 8 p.m. Clear Stream Parents Get Together 7 p.m. & PTA Gen. Mtg. 8 p.m.</p>	<p>18</p> <p>Shaw T-Shirt Sale 2:45 p.m.</p>	<p>19</p> <p>Forest PTA Candy & Gift Wrap Sale Begins</p> <p>Shaw Dance/Twirl Registration, 2:45 p.m.</p>	<p>20</p>	<p>21</p>
<p>22</p> <p>Rosh Hashanah Schools Closed</p>	<p>23</p>	<p>24</p> <p>Clear Stream T-Shirt Sale 2:30 p.m.</p>	<p>25</p> <p>Clear Stream T-Shirt Sale 2:30 p.m.</p>	<p>26</p>	<p>27</p>	<p>28</p> <p>Forest School Picture Day</p> <p>Dist. 30 Bd. of Ed. Mtg. 8 p.m.</p>
<p>29</p> <p>Shaw Gift Wrap Begins</p>	<p>30</p> <p>Yom Kippur Schools Closed</p>	<p>31</p>	<p>32</p>	<p>33</p>	<p>34</p>	<p>35</p>



SHADED BOX
INDICATES
SCHOOL IS CLOSED

FOREST ROAD PARENT TEACHER ASSOCIATION 1998-1999

POSITION	ELECTED OFFICERS	TELEPHONE NO.	POSITION	ELECTED OFFICERS	TELEPHONE NO.
Co-Presidents	Jill Cohen Elly Haber Janet Bleier Andrea Bretscher Carol Kingsley Helene Harris Lisa Aponete Lisa Vogel Karen McDaniel Linda Kessler Jodi Fine	791-3407 791-1293 791-4353 791-2248 791-6134 791-8425 791-2807 568-1901 791-4574 791-6134 791-6134	Programming Committees Committee Chairperson Reflections	Linda Pellizzi Anne Falley Charlotte Lurie Sue Pepper Laura Feaser Lynn Smolin Helene Steiner Robin Teramo Andrea Bretscher Brigette LaPorte Dina Ciullo Linda Pellizzi	791-6582 791-6231 791-8662 791-3889 791-5904 791-6136 791-2971 791-6322 791-2248 791-6698 792-0216 791-6582
1st Vice President-Ways & Means			PARP		
2nd Vice President-Programming			Pre-School Field Day		
3rd Honorary Vice President					
Treasurer					
Recording Secretary					
Financial Secretary					
Corresponding Secretary					
Teacher Representatives					
EXECUTIVE BOARD COMMITTEE CHAIRPERSONS					
Administrative Committees	Jean Lowery Anne Falley Charlotte Lurie Alicia Barreto Laura Silverman Helene Harris Jean Lowery Maria Shea Mara Steindam Mara Steindam Maria Shea June Goldman Alan Goldman Jean Lowery Linda Kettering Sharon Hirsh Ellen Popper Jill Cohen Elly Haber Laura Silverman Melissa Gates June Goldman Laura Silverman Helene Steiner Andrea Bretscher Wendie Ciorciari Dina Ciullo Brigette LaPorte	791-6374 791-6231 791-8662 791-2019 791-4928 791-8425 791-6374 791-1606 791-8542 791-8542 791-1606 791-2666 781-2666 791-6374 792-0526 791-5142 791-6276 791-3407 791-1293 791-4928 791-2516 791-2666 791-4928 791-2971 791-2248 791-4266 792-0216 791-6698	Fundraising Committees Chairperson Book Fair Candy & Giftwrap Sale Carnival Chinese Auction Fashion Show Holiday Boutique Plant Sale Pumpkin Sale Raffles Summer Book Fair	Brigette LaPorte Barbara Levy Tammy Weinstock Janet Bleier Brigette LaPorte Sharon Hirsh Janet Bleier Brigette LaPorte Marianne Tomasulo Jill Cohen Elly Haber Shesyl Kaller Robin Teramo Helene Steiner Wendie Ciorciari Janet Bleier Barbara Levy Gina Toner Tammy Weinstock Janet Bleier Risa Spritzer Maria Shea Debbie Cohan Wendie Ciorciari Rochelle Gendelman Helene Harris	791-6698 791-1292 791-5870 791-4353 791-6698 791-5142 791-4353 791-6698 791-2659 791-3407 791-1293 791-1186 791-6322 791-2971 791-4266 791-4353 791-1292 791-2151 791-5870 791-4353 791-9644 791-1606 825-3118 791-4266 791-9146 791-8425
Delegates to Council					
Art Enrichment					
Banking Co-ordinator					
By-Laws					
Class Parent Co-ordinators					
Flyers					
Historian					
Hospitality					
Newsletter					
Nutrition Rep.					
Publicity					
School Board Rep.					
School Pictures					
SEPTA Rep.					
6th Grade Yearbook					
Staff Recognition Days					
Volunteer Appreciation					

School Policies

School Hours for all Schools

Kindergarten to Grade 6, including Special Classes: 8:30 a.m. to 2:45 p.m. First bell rings at 8:20 a.m. Check with your school regarding availability of supervision for students who arrive before 8:20 a.m.

Breakfast

Students participating in the District Breakfast Program should not arrive before 7:50 a.m. **Supervision is not provided for students prior to that time.**

Lunch

Lunch is served beginning on the first day of school. Pupils may go home for lunch, bring lunch from home, or buy the school lunch in the cafeteria. **Students are not permitted to leave school for lunch unless picked up by a parent or authorized adult.** Monthly menus are provided. In case a child forgets or loses his/her lunch money, there is a charge system to cover the emergency.

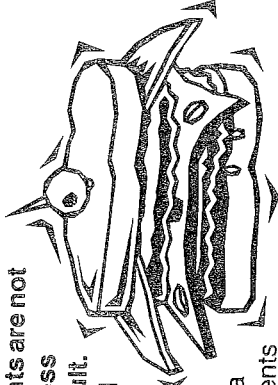

The secretary keeps the record of such charges and contacts the parents should a charge not be paid in a reasonable time. Students may purchase prepaid lunch tickets. Each ticket provides 20 meals, and is valid until June, or until all 20 meals are used. All tickets will remain with the Cafeteria Cashier.

Snack Milk & Juice

Snack milk & juice are sold to all children beginning the first day of school. You will be notified as to exact date for payment. In case of a child's absence, no refund is made for period of less than a full week.

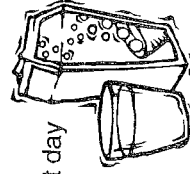

Absences

When your child has been absent, State law requires that he/she bring a note from you explaining the absences and the date(s) of absence(s). The note should be presented to the nurse **before** he/she goes to the classroom. Please be specific. Just saying, "he/she was ill", is not enough. Indicate whether it was "virus", "fever", "cold", etc.

A note is required for an absence due to a religious holiday. A note is required for any tardiness, giving the reason. If your child contacts a contagious disease,

such as mumps, measles, etc., please phone the school nurse so that she can alert the parents in your child's class that their children have been exposed. Be sure to keep the emergency card up to date so that we will know whom to call should your child become ill and have to go home.

Noon Hour Rules

Students who repeatedly misbehave in the cafeteria, auditorium, or on the playground during the noon hour, may be excluded from staying in school for lunch for a few days. If you receive such a note from the principal/teacher, we would appreciate your cooperation. Whether or not a parent is home during the noon hour has no bearing on this exclusion.

Exits and Entrances

Your child's class is assigned a specific exit and entrance to use. You will thus know where to meet him/her when you come to pick up. Parents picking up children are asked to meet them at the exit, **not the classroom**. Parents must wait outside the school at dismissal time.

Class Interruptions

No unnecessary interruptions of classes are allowed once the day's sessions have begun. When your child forgets a book, homework, sneakers, lunch money, etc., please bring these to the office. All pupils are instructed to check with the office at lunch time for such forgotten items. In the interest of the child's all-round education, we urge you not to make a practice of bringing forgotten items to school. The child should be developing his/her own sense of responsibility for these things.

Physical Education Attire and Sneakers

Boys and girls are required to wear appropriate attire and sneakers on assigned gym days. **NO ONE IS ALLOWED ON THE GYM FLOOR WITHOUT SNEAKERS.**

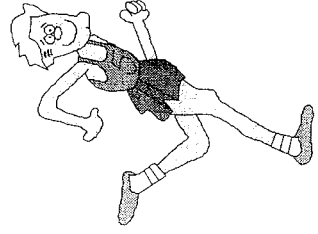

School Policies

Appointments with Teachers

In order that pupils' class time be used to the fullest advantage, we request that parents do not seek conferences with teachers during school hours. If you wish a conference, please make an appointment to see the teacher after school. Teachers are available for such conferences every day except Wednesdays and Fridays.

Bicycles

NO bicycles are allowed at either Forest Road or Clear Stream Avenue Schools because no child lives far enough from the school to make them necessary. They are allowed at Shaw, but are restricted to pupils in grades 4, 5, and 6 who live NORTH OF FOSTER AVENUE. **Bicycle operators must wear safety helmets.** All must have a lock and chain for safety purposes.

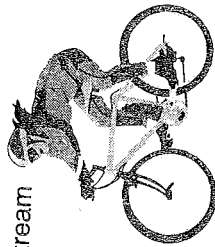

Gifts to Teachers Prohibited

The policy of the school district which became effective January 1956, is to prohibit the acceptance of gifts by faculty members on school premises, and to prohibit the solicitation of funds for personal gifts purposes, by any person, or persons, on the premises.

In-Day Program

In inclement weather, there is an in-day program of motion pictures or quiet games provided for those pupils who eat in the cafeteria. Pupils who go home to lunch are not allowed to participate in this program because of space limitations, so we ask parents to return these pupils to school on such days just in time for the afternoon session - not before five minutes prior to their scheduled lunch time.

Homework Requirements

Classroom learning is improved through effective homework assignments. Homework may include review, reinforcement, reading in preparation for classroom discussion, analysis and research. Homework helps students establish

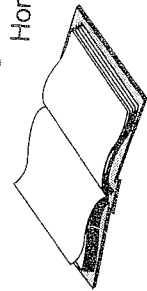

work habits which will influence their use of time throughout life. Homework is required of all pupils, but it will vary from day to day. First and second grade pupils may have fifteen to twenty minutes of homework per day, while third and fourth grade pupils are likely to have thirty to forty minutes. Fifth and sixth graders are expected to devote as much as an hour to homework. Students should require little if any help from parents in completing assignments.

However, parents may assist students by insuring that they have a quiet, comfortable place to work.

Lost and Found

Unmarked articles lost by pupils are placed in the Lost-and-Found, which is in the Nurse's Office at Clear Stream, Shaw and Forest. Such articles, if not claimed at the end of the school year, are given to a charitable organization. However, any article bearing a child's name is returned directly to him/her. Please place your child's name on all his/her belongings.

Assemblies

When your child's class puts on an assembly program, we welcome your attendance, but we do ask you not to bring pre-school children. As much as we realize that it is a thrill for them to see older siblings perform, they are often distracting to all concerned. Picture taking or video taping are not allowed without prior approval.

Medication

When it is necessary for the child to take internal medication during school hours, the nurse will cooperate with the family physician and the parents. The parent must submit a written request to the Nurse with a written request from the family physician indicating the frequency and dosage of a prescribed medication. Then the school nurse will administer this medication during the school hours. Under no circumstances will a child be permitted to carry or to take medication by himself or herself.

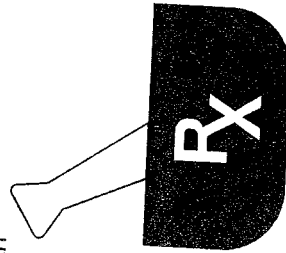

Special Services and Programs

It is the commitment of District Thirty to provide challenging and successful educational experiences for all children. Such challenges and successes will differ from child to child. The Office of Special Services and Programs is responsible for coordinating the various district-wide activities which promote school success for every child. Included in these activities are standardized testing, reading remediation, English as a Second Language, Gifted and Talented Education, speech and language therapy, health screening, counseling, and special education services.

Through the committee on Special Education (CSE) and the Committee on Pre-School Special Education (CPSE) children are assessed to determine eligibility for special education services. If a school-aged child is determined to have a disability, appropriate services will be provided within the consideration of the least restrictive environment. Appropriate services and instruction are determined by CSE/CPSE review and incorporated in the student's Individualized Education Program (IEP). Within District Thirty, students may receive IEP related services such as speech and language therapy, resource room, counseling, and occupational/physical therapy while participating in the regular education program. Learning Center (LC) classes provide instruction in reduced size learning environments with opportunities to be mainstreamed (as appropriate) into regular education classes. Some children because of their unique needs may benefit from out-of-district classes in neighboring school districts, BOCES programs, or private school placements. In any case, successfully meeting the needs of each child with a disability is the result of meaningful collaboration among parents, teachers, related services staff, administrators, and the CSE.

For preschool children between three and five years of age, the Committee on Pre-School Special Education (CPSE) process is designed to identify children who may be in need of special education services. Parents who suspect that their preschool child may not be attaining age-expected developmental behaviors are encouraged to contact the Director of Special Services for information about CPSE and the types of services available to eligible children. The Office of Special Services and Programs also coordinates with the Early Intervention Program of the Nassau County Department of Health to provide a smooth transition of services for infants and toddlers with disabilities to CPSE.

District Thirty also provides services to eligible children as specified by Section 504 of the Rehabilitation Act of 1973. The Director of Special Services and Programs is also the Section 504 Coordinator for the district.

The Office of Special Services and Programs is located at Washington Avenue Administrative Building; the phone number is 285-9833.

Elaine Faling
CSE/CPSE Secretary

Gene Nyitray
Director

Lillian Grazian
Secretary

Vandalism

Vandalism costs money. Help us to reduce this drain on our tax dollars by keeping a watchful eye on your local school. Perhaps you have noticed persons on school grounds who were behaving suspiciously or actually engaged in vandalism, but you have not known where to call.

To report school vandalism or suspicious activities at your school, call the Nassau County Emergency Number 911. Give the name of the school, its location, and a brief description of what is happening. A police car will be radio-dispatched to investigate, and appropriate school personnel will be alerted. School officials will prosecute offenders whenever possible and attempt to secure restitution for damages.

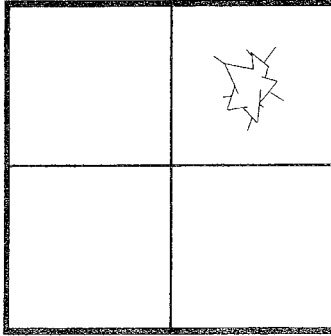

Please report any of these activities:

- persons on the roof of the school
- anyone throwing objects at windows
- someone shooting weapons of any kind
- any kind of fire on school grounds
- destruction of grounds, shrubbery, or facility
- anyone operating mini-bikes on playgrounds or driveway
- any other suspicious or criminal acts

Use of School Facilities

The Board of Education encourages the use of school facilities for community purposes when such use does not interfere with the scheduled school program. Organizations desiring to use school facilities should request an "Application for the Use of School Facilities" form from the principal of the school involved. Administrative rules and a statement of costs are explained on the application form.

School Visits

Parents are encouraged to visit school to meet the members of the professional staff, to examine the facilities, and instructional programs, and to share ideas. Those wishing to observe classes or to meet with staff members should arrange the visit in advance so that the time is appropriate and does not interfere with planned activities.

All visitors must register at the school office upon arrival, before visiting other parts of the building.

At dismissal times, parents picking up students are requested to meet them at a previously designated spot outside of the school. Dismissal exits have been assigned to classes in each building. Students are expected to leave the school building and school property in an orderly fashion at dismissal time each day. Such procedures are necessary to insure the safety of all students.

School Closings or Delayed Openings

Weather and other emergencies may warrant school closings or delayed openings. A delayed opening means students are expected to be at school at 10 AM. PTA Class Parents will be informed and will initiate telephone calls to inform parents in each class. NEWS 12 on Channel 12 will carry school closing information. Such school closings or delays will be also announced on the following local radio stations:

WCBS (AM)	88	WHLI (AM)	1100
WGBB (AM)	1240	WINS (AM)	1010
WGSM (AM)	740	WALK (FM)	97.5
		WALK (AM)	1370



School Telephone Directory

Main Office: Washington Avenue School	
Superintendent	285-9881
Business Office	285-9880
Curriculum Office	285-9833
FAX	285-9839
Clear Stream Avenue School	
Principal's Office	872-4333
Nurse's Office	872-4336
Forest Road School	
Principal's Office	791-6134
Nurse's Office	791-6790
Shaw Avenue School	
Principal's Office	872-4320
Nurse's Office	872-4327
Special Services	
Computer Coordinator/AV Consultant	872-4342
Committee for Special Education, Chairperson	285-9820
Sp. Ed. Parent Reps. Mr. Winston Yarde	285-6567

Index

Board of Education	Page 2
District Staff	Page 4
Special Services and Programs	Page 5
General Information	Page 6
Weather Closings	Page 6
School Policies	Pages 7 & 8
Clear Stream PTA	Page 9
Forest Road PTA	Page 10
Shaw Avenue PTA	Page 11
Monthly Calendars	Pages 12 - 23
Valley Stream Council of PTA's & SEPTA	Page 22

Valley Stream High School District

Central High School	561-4400
Memorial Junior High School	872-7700
North High School	564-5500
South High School	791-0300

Valley Stream School District No. 30 and Valley Stream Central High School District Valley Stream, New York

District No. 30 Schools
 Shaw Avenue A
 Clear Stream Avenue B
 Forest Road C
 Washington Avenue D
 (District Office)

High Schools
 North High 1
 Memorial Jr. High 2
 Central High 3
 South High 4

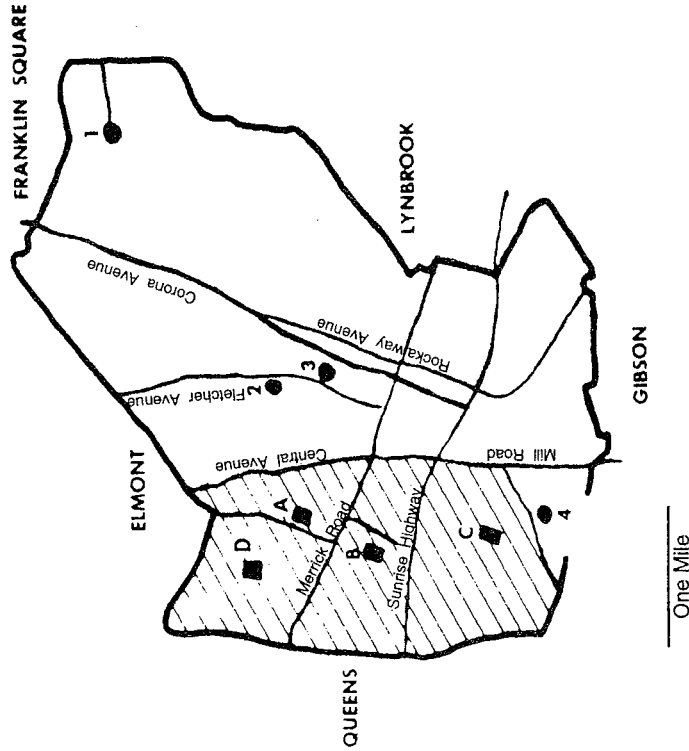

Calendar Preparation:

Mr. Robert Cohen
 Doreen Imbriani

Cover Design:

Sara Palazzolo

School Administration
Dr. Vincent Beni, Interim BOCES District Superintendent

Lawrence R. McGoldrick
Superintendent of Schools

Gene Nyitray
Assistant Superintendent of Schools

Helen C. DeSilva
Assistant to the Superintendent for Business

School Principals

Clear Stream Avenue School
Mr. Robert A. Cohen

Forest Road School
Mrs. Carol Kingsley

Shaw Avenue
Mr. Henry Mazer

Director of Facilities
Gregory Abbate

Secretary to Superintendent
Madelaine Furst

School Secretaries
Doreen Imbriani, Clear Stream Avenue
Angela Nicolini, Forest Road
Daryl Rossello, Shaw Avenue

Secretarial Staff
Marilyn Berkowitz
Carol Blankshine
Elaine Faling
Lillian Grazian
Mabel Hom
Marilyn Russo
Anne O'Brien
Kathy Scuderi

School Nurses
Sally Kaplan,
Forest Road
Alyce Gardner,
Clear Stream Avenue
Sue Lombardo,
Shaw Avenue

JUNE 1999

DAY
Su M Tu W Th F Sa
2 3 4 5 6 7 8
9 10 11 12 13 14 15
16 17 18 19 20 21 22
23 24 25 26 27 28 29
30 31

July
Su M Tu W Th F Sa
4 5 6 7 8 9 10
11 12 13 14 15 16 17
18 19 20 21 22 23 24
25 26 27 28 29 30 31

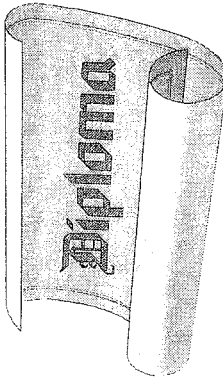
SUNDAY	MONDAY	TUESDAY	WEDNESDAY	THURSDAY	FRIDAY	SATURDAY
6	7 	1 Gr. 4 NYS Mathematics Test Shaw PTA Social Mtg. 8 p.m. VSCHSD Bd. of Ed. Comm. Mtg. 8 p.m.	2 Clear Stream PTA Gen. Mtg. 9 a.m. Clear Stream PTA Installation Dinner 7 p.m.	3	4 Shaw PTA Father's Day Boutique	5
13	14 VS PTA Council Mtg. 7:30 p.m. Memorial J.H.S.	8 Clear Stream/Forest Banking Forest PTA Staff Appreciation Luncheon VSCHSD Bd. of Ed. Mtg. 8:30 p.m.	9	10	11 Forest PTA Volunteer Appreciation Breakfast 9:00 a.m. Shaw Father's Day Dance 7:30 - 10 p.m.	12
20	21 VS SEPTA Mtg. Memorial J.H.S. 8 p.m. Dist. 30 Bd. of Ed. Comm. Mtg. 8 p.m.	15 Forest PTA Exec. Bd. Mtg. 8:30 a.m.	16	17 Forest PTA Summer Book Fair 9 a.m. - 2:30 p.m. Clear Stream Father's Day Boutique	18	19
27	28 Dist. 30 Bd. of Ed. Mtg. 8 P.M.	22 VS SEPTA Mtg. Memorial J.H.S. 8 p.m. Dist. 30 Bd. of Ed. Comm. Mtg. 8 p.m.	23 CLEAR STREAM/FOREST/SHAW 6th Grade Closing Exercises 8:15 p.m.	24 Clear Stream/Forest/Shaw Kindergarten Graduation 9:00 a.m. Clear Stream/Forest/Shaw 6th Gr. Parties 1 - 3 p.m.	25 LAST DAY OF SCHOOL 8:30 - 9:30 a.m.	26
		29	30			SHADED BOX INDICATES SCHOOL IS CLOSED

SEPTA

Valley Stream Officers for 1997-1998

Co-President: Dominique Wiener 825-4702
 Vice Presidents: Robert Musmacher 568-9604
 Joanne Cammalleri 825-668
 Hon. Vice Pres.
 Treasurer: Melissa Gates 791-2516
 Rec. Secretary: Rose Barbaro 561-8018
 Correspond. Secty.: Pat Torres 561-3154
 Delegate to Council: Petra Hurney 561-7558
 Delegate to
 SEPTA/BOCES: Joanne Altrui 488-4255
 Robert Musmacher 568-9604
 Past President:

Valley Stream Council of PTA's Elected Officers

President: Ann Marie Costiglio 791-1799
 First V. Pres: Ann Marie Konzet 825-2572
 Scholarship: Cathy Rotkowitz 599-1637
 Treasurer: Patti Schwartz 791-1346
 Rec. Secretary: Carol Jakubowski 872-6306
 Correspond. Secty.: Lorraine Marino 596-1827
 Past President: Anne Winn 825-5768

JULY 1999						
SUNDAY	MONDAY	TUESDAY	WEDNESDAY	THURSDAY	FRIDAY	SATURDAY
4	5	6	7	8	9	10
11	12	13	14	15	16	17
18	19	20	21	22	23	24
25	26	27	28	29	30	31

AUGUST 1999						
SUNDAY	MONDAY	TUESDAY	WEDNESDAY	THURSDAY	FRIDAY	SATURDAY
1	2	3	4	5	6	7
8	9	10	11	12	13	14
15	16	17	18	19	20	21
22	23	24	25	26	27	28
29	30	31				



Su	M	Tu	W	Th	F	Sa
4	5	6	7	8	9	10
11	12	13	14	15	16	17
18	19	20	21	22	23	24
25	26	27	28	29	30	

MAY 1999

Su	M	Tu	W	Th	F	Sa
6	7	8	9	10	11	12
13	14	15	16	17	18	19
20	21	22	23	24	25	26
27	28	29	30			

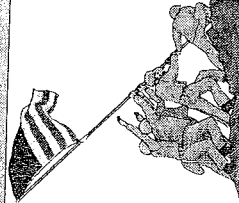
SUNDAY	MONDAY	TUESDAY	WEDNESDAY	THURSDAY	FRIDAY	SATURDAY
2 SHADED BOX INDICATES SCHOOL IS CLOSED	3 VSCHSD Bd. of Ed. Comm. Mtg. 8 p.m.	4 Gr. 5 NYS Writing Test Part 1 Shaw Banking Ends Gr. K-2 Shaw PTA Gen. Mtg. & Volunteer Night 8 p.m. Budget Hearing (Dist. 13) 8 p.m. Dever	5  Forest PTA Plant Sale Pre- Order Pick Up Budget Hearing (Dist. 30) 8 P.M. Forest Rd.	6 Gr. 5 NYS Writing Test Part 2 Forest PTA Plant Sale 9 a.m.-2:30 p.m. Shaw Banking ends Gr. 3-6, LCII Shaw PTA Mother's Day Boutique 6:45 p.m. & PTA Gen. Mtg. 7:30 p.m. Clear Stream PTA Exec. Mtg. Budget Hearing (Dist. 24) 8:15 p.m. W.L. Buck	7 Forest Rd. PTA Plant Sale 9 a.m. - 2:30 p.m. Clear Stream PTA Mother's Day Plant Sale Shaw PTA Mother's Day Dance 7:30 - 10 p.m.	8 Shaw Tots to Teens Show Keller Auditorium Central H.S. 7:30 p.m.
9	10 Memorial J.H.S. 6th Gr. Parents Orientation 7:30 p.m.	11 All Schools VOTER REGISTRATION 7-9 a.m. & 4-9 p.m. Clear Stream/Forest Banking Clear Stream Pre-School "Tour The School" Mtg. 7:30. pm. Forest PTA Exec. Bd. Mtg. 8:30 a.m. VSCHSD Bd. of Ed. Mtg. 8:30 p.m.	12	13	14 Shaw PTA Installation Dinner	15
16	17 VS SEPTA Mtg. Memorial J.H.S. 8 p.m. Dist. 30 Bd. of Ed. Comm. Mtg. 8 p.m.	18 Clear Stream/ Forest Banking VOTING - All Schools Dist. 13 & 30 7 a.m.-10 p.m. Dist. 24 7 a.m. - 9 p.m. DISTRICT ART EXHIBIT 7:30-9 p.m.	19	20	21 Shaw Teacher Recognition District 30 Annual Dinner Dance	22
23	24 Dist. 30 Bd. of Ed. Mtg. 8 p.m. MEMORIAL DAY Schools Closed Memorial Day Parade 9 a.m. 31	25 Clear Stream/Forest Banking Forest PTA Installation Dinner 7:30 p.m.	26	27	28	29
30	31					

MARCH 1999

Feb
Su M Tu W Th F Sa
1 2 3 4 5 6
7 8 9 10 11 12 13
14 15 16 17 18 19 20
21 22 23 24 25 26 27
28

April
Su M Tu W Th F Sa
1 2 3
4 5 6 7 8 9 10
11 12 13 14 15 16 17
18 19 20 21 22 23 24
25 26 27 28 29 30

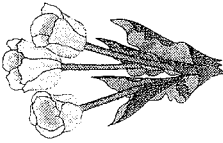
SUNDAY	MONDAY	TUESDAY	WEDNESDAY	THURSDAY	FRIDAY	SATURDAY
<p>1</p> 	<p>2</p> <p>Clear Stream/Forest Banking</p> <p>Shaw PTA Gen. Mtg. 8 p.m.</p> <p>VSCHSD Bd. of Ed. Comm. Mtg. 8 p.m.</p>	<p>3</p>	<p>4</p>	<p>5</p> <p>Shaw - No Twirling</p>	<p>6</p> <p>Shaw PTA Kids Fun 10 a.m.-2 p.m.</p>	
<p>7</p>	<p>8</p> <p>Shaw PARP Begins</p> <p>Shaw - No Dance</p>	<p>9</p> <p>Forest PTA Exec. Bd. Mtg. 8:30 a.m.</p> <p>Clear Stream/Forest Banking</p> <p>Shaw Banking Gr. K-2</p> <p>VSCHSD Bd. of Ed. Mtg. 8:30 p.m.</p>	<p>10</p> <p>Clear Stream PTA Exec. Mtg. 6:45 p.m.</p> <p>Clear Stream PTA Gen. Mtg. 7:30 p.m.</p>	<p>11</p> <p>Shaw Banking Gr. 3-6, LCII</p>	<p>12</p> <p>Shaw - No Twirling</p>	<p>13</p> <p>Forest PTA Carnival 11 a.m. - 3 p.m.</p>
<p>14</p>	<p>15</p> <p>VS SEPTA Mtg. Memorial JHS 8 p.m.</p> <p>Dist. 30 Bd. of Ed. Comm. Mtg. 8 p.m.</p>	<p>16</p> <p>Clear Stream/Forest Banking</p>	<p>17</p> <p>Clear Stream Pre-School Mtg. 1:30 p.m.</p>	<p>18</p> <p>Clear Stream PTA Fashion Show 7 p.m. - Russo's on the Bay</p>	<p>19</p>	<p>20</p>
<p>21</p>	<p>22</p> <p>Dist. 30 Bd. of Ed. Mtg. 8 p.m.</p>	<p>23</p> <p>Clear Stream/Forest Banking</p> <p>Shaw Banking Gr. K-2</p> <p>PTA Day in Albany</p>	<p>24</p> <p>Shaw Pre-School Mtg. 3-4 p.m.</p>	<p>25</p>	<p>26</p> <p>Breakfast w/Supt. 8:30 a.m. Clear Stream</p> <p>Shaw Book Fair</p>	<p>27</p> <p>Shaw Moonlight Bowl</p>
<p>28</p>	<p>29</p> <p>Clear Stream/Forest Banking</p>	<p>30</p> <p>Clear Stream/Forest Banking</p>	<p>31</p>	<p>Shaded box indicates school is closed</p>		



FEBRUARY 1999

January

Su	M	Tu	W	Th	F	Sa
3	4	5	6	7	8	9
10	11	12	13	14	15	16
17	18	19	20	21	22	23
24	25	26	27	28	29	30
31						

March

Su	M	Tu	W	Th	F	Sa
7	8	9	10	11	12	13
14	15	16	17	18	19	20
21	22	23	24	25	26	27
28	29	30	31			

SUNDAY	MONDAY	TUESDAY	WEDNESDAY	THURSDAY	FRIDAY	SATURDAY
1 	1 VS PTA Council Mtg. 7:30 p.m. - Carbonaro	2 Clear Stream/Forest Banking Shaw Banking Gr. K-2 Shaw PTA Gen. Mtg. 8 p.m.	3 Clear Stream PTA Gen. Mtg. 9 a.m.	4 Shaw Banking Gr. 3-6, LCII	5 Clear Stream PAPP Program Ends Clear Stream Parent/Child Night 7 p.m.	6 VSCHSD Budget Review
7	8 Shaw Candy Sale Begins VS SEPTA Mtg. Memorial JHS 8 p.m.	9 Forest PTA Exec. Bd. Mtg. 8:30 a.m. Clear Stream/Forest Banking Forest PTA PAPP Ends VSCHSD Bd. of Ed. Mtg. 8:30 p.m.	10 Shaw Pre-School Meeting 3-4 p.m. Dist. 30 PTA Founders Day 7:30 p.m. Clear Stream	11	12 Lincoln's Birthday	13
14	15 WINTER RECESS Schools Closed	16	17	18	19	20
21	22 Washington's Birthday Shaw Candy Sale Ends Dist. 30 Bd. of Ed. Mtg. 8 p.m.	23 Clear Stream/Forest Banking Shaw Banking Gr. K-2	24	25	26 Shaw Banking Gr. 3-6, LC II Shaw PTA Supermarket Fun Shaw - No Twirling	27
28						SHADED BOX INDICATES SCHOOL IS CLOSED

Number						
Su	M	Tu	W	Th	F	Sa
6	7	8	9	10	11	12
13	14	15	16	17	18	19
20	21	22	23	24	25	26
27	28	29	30	31		

Feb.						
Su	M	Tu	W	Th	F	Sa
7	8	9	10	11	12	13
14	15	16	17	18	19	20
21	22	23	24	25	26	27
28						

JANUARY 1999

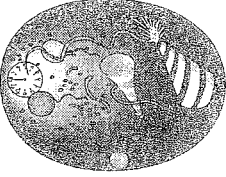
SUNDAY	MONDAY	TUESDAY	WEDNESDAY	THURSDAY	FRIDAY	SATURDAY
3 	4 Schools Reopen	5 Forest PTA Exec. Bd. Mtg. 8:30 a.m. Clear Stream/Forest Banking Shaw Banking Gr. K-2 Shaw PTA Gen. Mtg. 8 p.m. VSCHSD Bd. of Ed. Comm. Mtg. 8 p.m.	6 Clear Stream PTA Exec. Mtg. 6:45 p.m. Clear Stream PTA Gen. Mtg. 7:30 p.m.	7 Shaw Banking Gr. 3-6, LCII	8 Breakfast w/Supt. 8:30 a.m. - Forest Clear Stream PARRP Program Begins	9
10 All County Elementary Concerts at C.W. Post Tilles Center 12 p.m.	11 NYS Gr. 4 ELA Tests	12 Clear Stream/Forest Banking VSCHSD Bd. of Ed. Mtg. 8:30 P.M.	13	14	15	16
17	18 Dist. 30 Bd. of Ed. Comm. Mtg. 8 P.M. Martin Luther King, Jr. Day Schools Closed	19 Shaw Banking Gr. K - 2	20	21 Shaw Banking 3-6, LCII	22 Clear Stream PTA Supermarket Bingo 7:30 p.m.	23
24	25 Dist. 30 Bd. of Ed. Mtg. 8 p.m.	26 Clear Stream/Forest Banking Forest PTA PARRP Program Begins Shaw PTA Cupcake Sale	27 Forest Book Fair 9 a.m. - 2:30 p.m.	28 Forest PTA Gen. Mtg. 8:30 a.m. Forest PTA Book Fair 9 a.m. - 2:30 p.m.	29 Superintendent's Conference Day (Tentative) School is Closed Shaw - No Twirling	30 Shaw Fun Fair 10 a.m. - 2 p.m.
31						

November

Su M Tu W Th F Sa
 1 2 3 4 5 6 7
 8 9 10 11 12 13 14
 15 16 17 18 19 20 21
 22 23 24 25 26 27 28
 29 30

January

Su M Tu W Th F Sa
 3 4 5 6 7 8 9
 10 11 12 13 14 15 16
 17 18 19 20 21 22 23
 24 25 26 27 28 29 30
 31

DECEMBER 1998

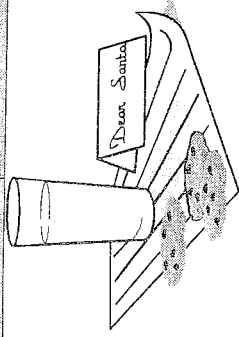
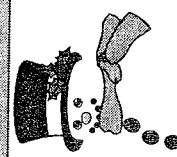
SUNDAY	MONDAY	TUESDAY	WEDNESDAY	THURSDAY	FRIDAY	SATURDAY
6	7 	8 Forest PTA Exec. Bd. Mtg. 8:30 a.m. Clear Stream/Forest Banking Shaw Banking Gr. K - 2 Nassau District Presidents/Principals Dinner	9 Clear Stream PTA Gen. Mtg. 9 a.m.	10 Forest PTA Holiday Boutique 9 a.m. - 2:30 p.m. Shaw Banking Gr. 3-6, LC II Clear Stream Holiday Boutique 9 a.m. - 2:30 p.m. VSCHSD Bd. of Ed. Comm. Mtg. 8 p.m.	11 Forest PTA Holiday Boutique 9 a.m. - 2:30 p.m. Clear Stream Holiday Boutique 9 a.m. - 2:30 p.m.	12 VSCHSD Building Tour 8 a.m.
13	14 VS PTA Council Mtg. 7:30 p.m. - Wheeler	15 Forest PTA Exec. Bd. Mtg. 8:30 p.m. Clear Stream/Forest Banking Shaw Banking Gr. K-2 Forest Winter Concert 7:30 p.m.	16 Clear Stream/Forest Banking Shaw Winter Concert 7:30 p.m.	17 Clear Stream Winter Concert, 7:30 p.m. Shaw Banking Gr. 3-6, LCII	18 Shaw Holiday Boutique Shaw - No Twirling	19 Shaw Breakfast w/Santa 9 - 11 a.m. Clear Stream Breakfast w/Santa 10 a.m. - 12 p.m.
20	21 Dist. 30 Bd. of Ed. Mtg. 8 p.m.	22 Clear Stream/Forest Banking Shaw Banking Gr. K-2 Forest Winter Concert 7:30 p.m.	23 Shaw Winter Concert 7:30 p.m.	24 CHRISTMAS RECESS Schools Closed	25 CHRISTMAS RECESS Schools Closed	26 CHRISTMAS RECESS Schools Closed
27	28 CHRISTMAS RECESS Schools Closed	29 CHRISTMAS RECESS Schools Closed	30 CHRISTMAS RECESS Schools Closed	31 CHRISTMAS RECESS Schools Closed		SHADED BOX INDICATES SCHOOL IS CLOSED

Su M Tu W Th F Sa
 4 5 6 7 8 9 10 11 12 13 14 15 16 17 18 19 20 21 22 23 24 25 26 27 28 29 30 31

December
 Su M Tu W Th F Sa
 6 7 8 9 10 11 12 13 14 15 16 17 18 19 20 21 22 23 24 25 26 27 28 29 30 31

NOVEMBER 1998

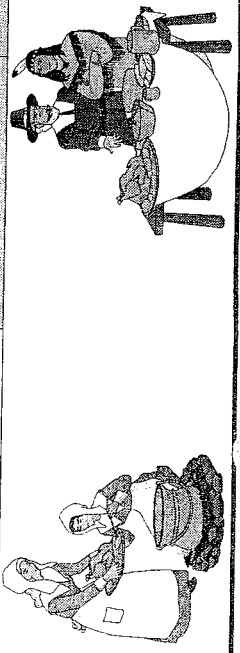
SUNDAY	MONDAY	TUESDAY	WEDNESDAY	THURSDAY	FRIDAY	SATURDAY	
1	2	3 ELECTION DAY 6 A.M. - 9 P.M. FOREST/SHAW.	4 Clear Stream PTA Exec. Mtg. 6:45 p.m. Clear Stream PTA Gen. Mtg. 7:30 p.m.	5 Shaw Banking Gr. 3-6 LCII Shaw Book Fair	6 Shaw Book Fair	7 VSUFSD 30 Building Inspection	
8	9 VSCHSD Bd. of Ed. Mtg. 8:30 p.m.	10 Shaw PTA Gen. Mtg. 8 a.m. Forest PTA Exec. Bd. Mtg. 8:30 a.m. Clear Stream/Forest Banking	11 VETERAN'S DAY Schools Closed	12 Clear Stream Picture Retakes	13 Shaw Breakfast w/Santa Ticket Sale 2:45 p.m.	14 PTA Convention - Buffalo N.Y.	
15	16 AMERICAN EDUCATION WEEK VS SEPTA Mtg. Memorial JHS 8 p.m. Dist. 30 Bd. of Ed. Comm. Mtg. 8 p.m.	17 Clear Stream/Forest Banking Shaw Banking Gr. K-2	18 Clear Stream Book Fair All Day Clear Stream Pre-School Mtg. 1:30 p.m. Forest PTA Gen. Mtg. 8 p.m.	19 Shaw Banking Gr. 3-6 LCII Clear Stream Book Fair	20 Clear Stream Reflections Night 7:30 p.m.	21	
22	23 Dist. 30 Bd. of Ed. Mtg. 8 p.m.	24	25 Forest Thanksgiving Breakfast Shaw Picture Retakes	26 THANKSGIVING DAY Schools Closed	27 Thanksgiving Recess Schools Closed	28	
29	30 Forest PTA Reflections Program Begins	31					SHADED BOX INDICATES SCHOOL IS CLOSED

OCTOBER 1998

September
 Su M Tu W Th F Sa
 1 2 3 4 5
 6 7 8 9 10 11 12
 13 14 15 16 17 18 19
 20 21 22 23 24 25 26
 27 28 29 30

November
 Su M Tu W Th F Sa
 1 2 3 4 5 6 7
 8 9 10 11 12 13 14
 15 16 17 18 19 20 21
 22 23 24 25 26 27 28
 29 30

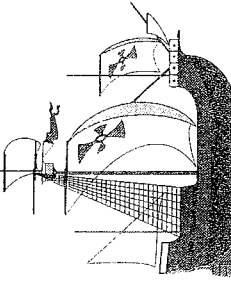
SUNDAY	MONDAY	TUESDAY	WEDNESDAY	THURSDAY	FRIDAY	SATURDAY
4 SHADED BOX INDICATES SCHOOL IS CLOSED	5 Clear Stream Gr. 6 Outdoor Ed. Program	6  Shaw PTA Gen. Mtg. 8 p.m. VSCHSD Bd. of Ed. Comm. Mtg. 8 p.m.	7 Clear Stream PTA Gen. Mtg. 9 a.m. Forest PTA Candy/Gift Wrap Sale Ends Clear Stream Banking Regs. Shaw School Pictures Shaw Gr. 6 Outdoor Ed. Program	8 Clear Stream School Pictures	9 Clear Stream Candy/Gift Wrap Sale Begins	10
11	12 VS PTA Council Mtg. 7:30 p.m. - Shaw COLUMBUS DAY Schools Closed	13 Forest PTA Exec. Bd. Mtg. 8:30 a.m. Shaw Gr. 6 Outdoor Ed. Program Clear Stream/Forest Banking Shaw Gift Wrap Sale Ends Shaw Banking Registration Begins VSCHSD Bd. of Ed. Mtg. 8:30 p.m.	14 Shaw Gr. 6 Outdoor Ed. Program	15	16 Breakfast w/Supt. Shaw 8:30 A.M. Shaw Twirling Begins	17
18	19 Forest Gr. 6 Outdoor Ed. Program Shaw Dance Begins Clear Stream Reflections Begins VS SEPTA Mtg. Memorial JHS 8 p.m. Dist. 30 Bd. of Ed. Comm. Mtg. 8 P.M.	20 Clear Stream/Forest Banking Clear Stream Pumpkin Patch All Day	21 Shaw Gr. 6 Outdoor Ed. Program Clear Stream Pumpkin Patch Shaw Fingerprinting Forest PTA Gen. Mtg. 8 p.m.	22 Shaw Gr. 6 Outdoor Ed. Program	23 Shaw Pumpkin Patch Forest PTA Pumpkin Sale 9:00 a.m. - 2:30 p.m. Clear Stream Candy/Gift Wrap Sale Ends	24
25 Standard Time Begins	26 Dist. 30 Bd. of Ed. Mtg. 8 p.m.	27 Clear Stream/Forest Banking Shaw Banking Registration Ends	28	29 Clear Stream Reflections Program Ends Forest PTA Fashion Show 7:30 p.m.	30 Clear Stream 5th & 6th Gr. Halloween Party 5:30 - 7:30 P.M.	31

August
 Su M Tu W Th F Sa
 1 2 3 4 5 6 7
 8 9 10 11 12 13 14
 15 16 17 18 19 20 21
 22 23 24 25 26 27 28
 29 30 31

SEPTEMBER 1999

October
 Su M Tu W Th F Sa
 1 2 3 4 5 6 7 8 9
 10 11 12 13 14 15 16
 17 18 19 20 21 22 23
 24 25 26 27 28 29 30
 31

SUNDAY	MONDAY	TUESDAY	WEDNESDAY	THURSDAY	FRIDAY	SATURDAY
			1	2	3	4
5	6 Labor Day	7	8	9	10	11
12	13	14	15	16	17	18
19	20	21	22	23	24	25
26	27	28	29	30		

SHADED BOX
 INDICATES
 SCHOOL IS CLOSED

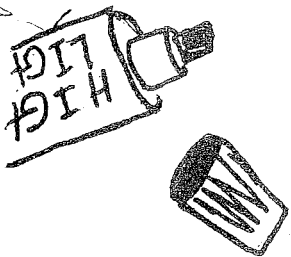
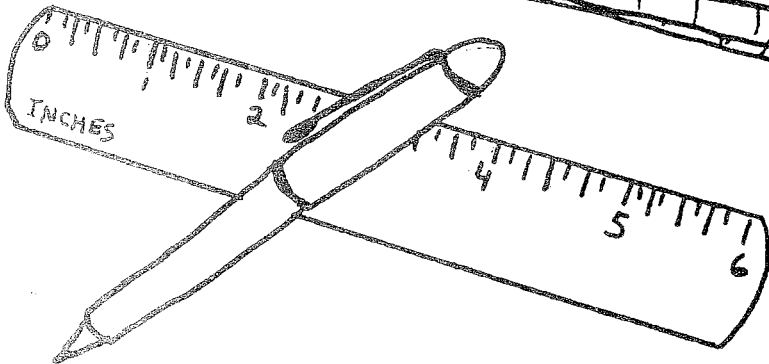
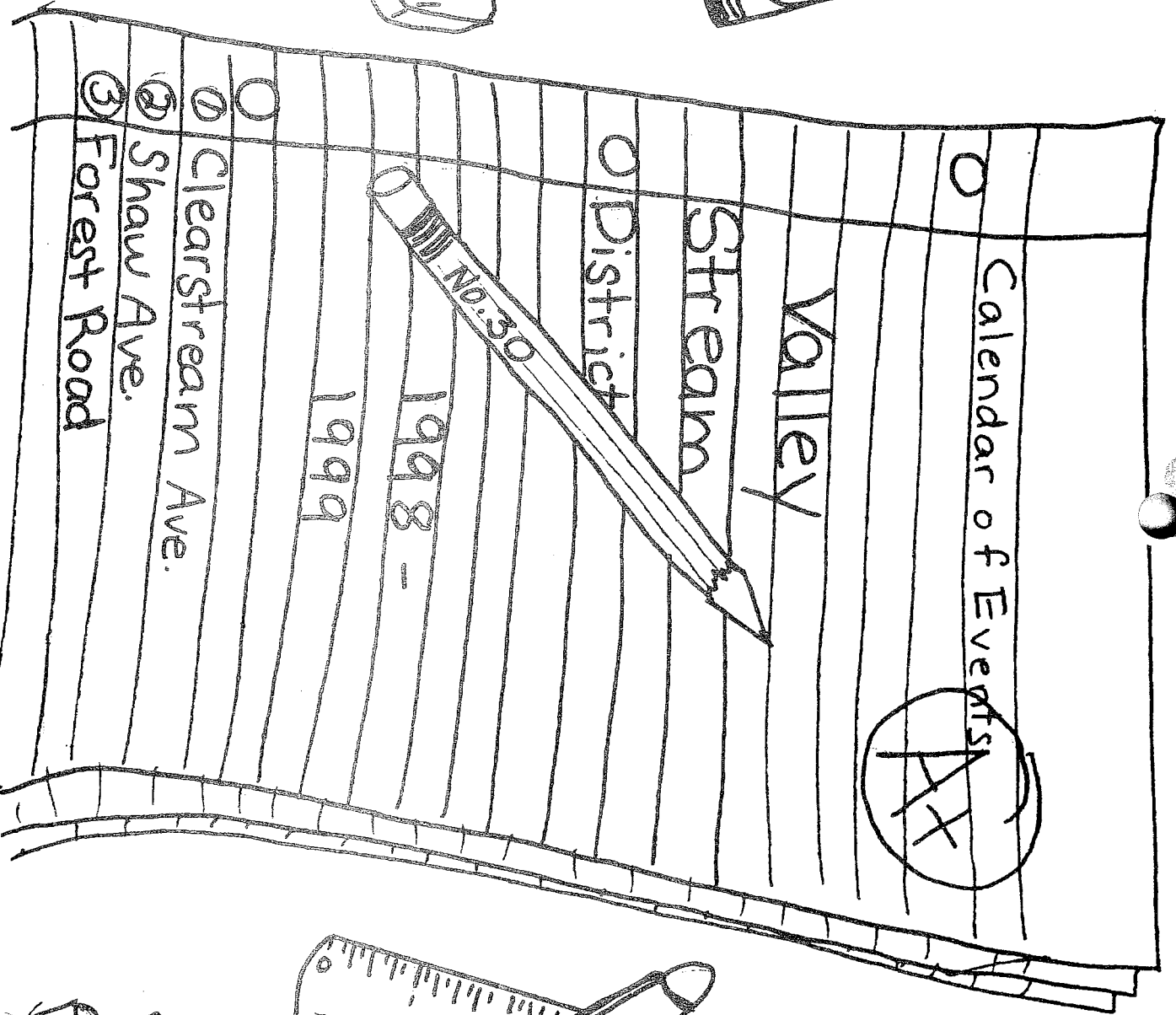
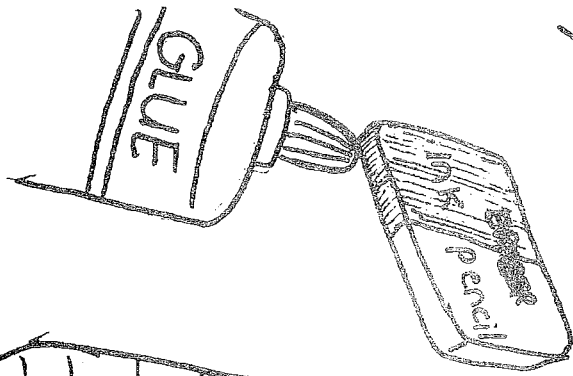

Valley Stream District 30 1999 - 2000

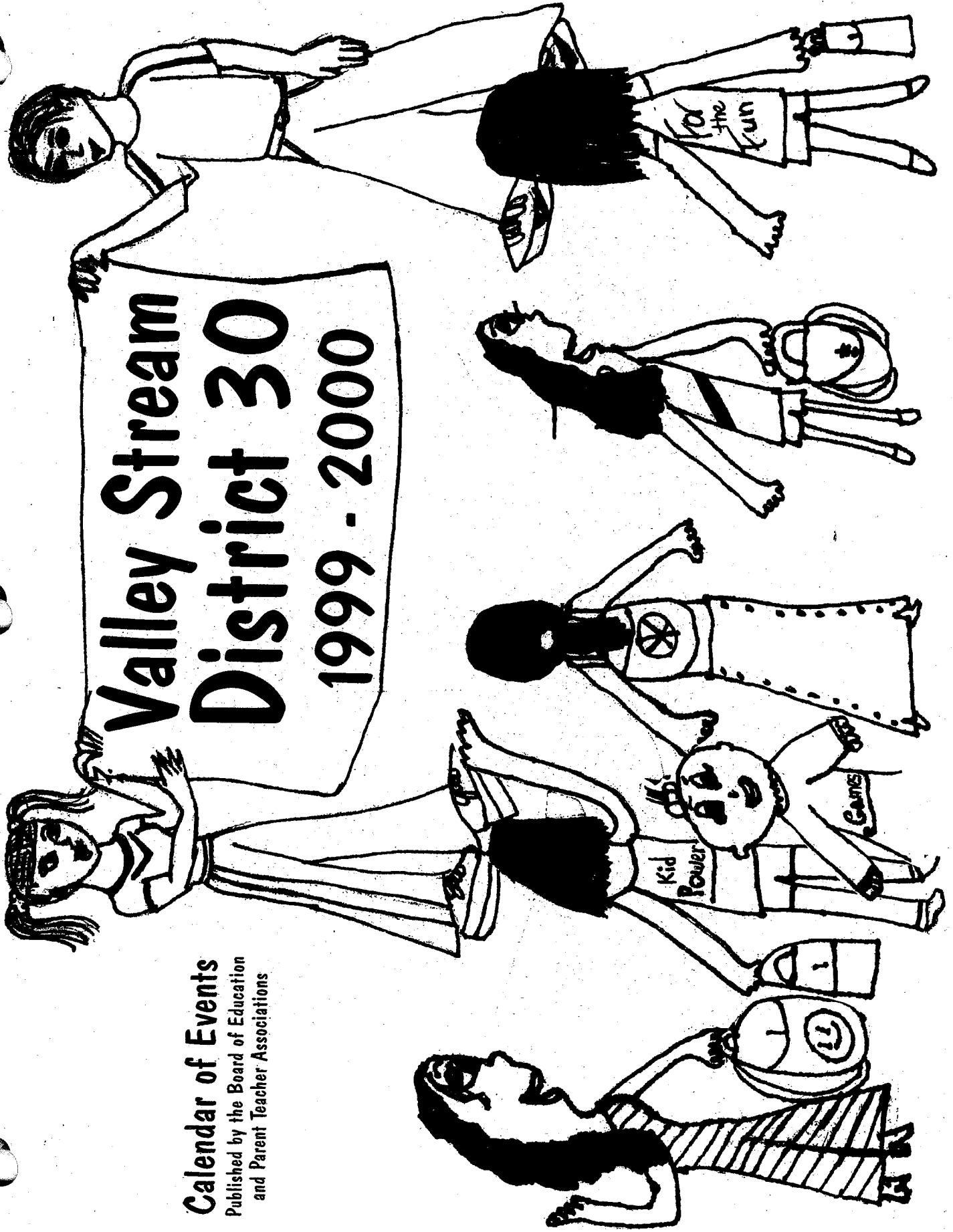

Calendar of Events
Published by the Board of Education
and Parent Teacher Associations

Board of Education

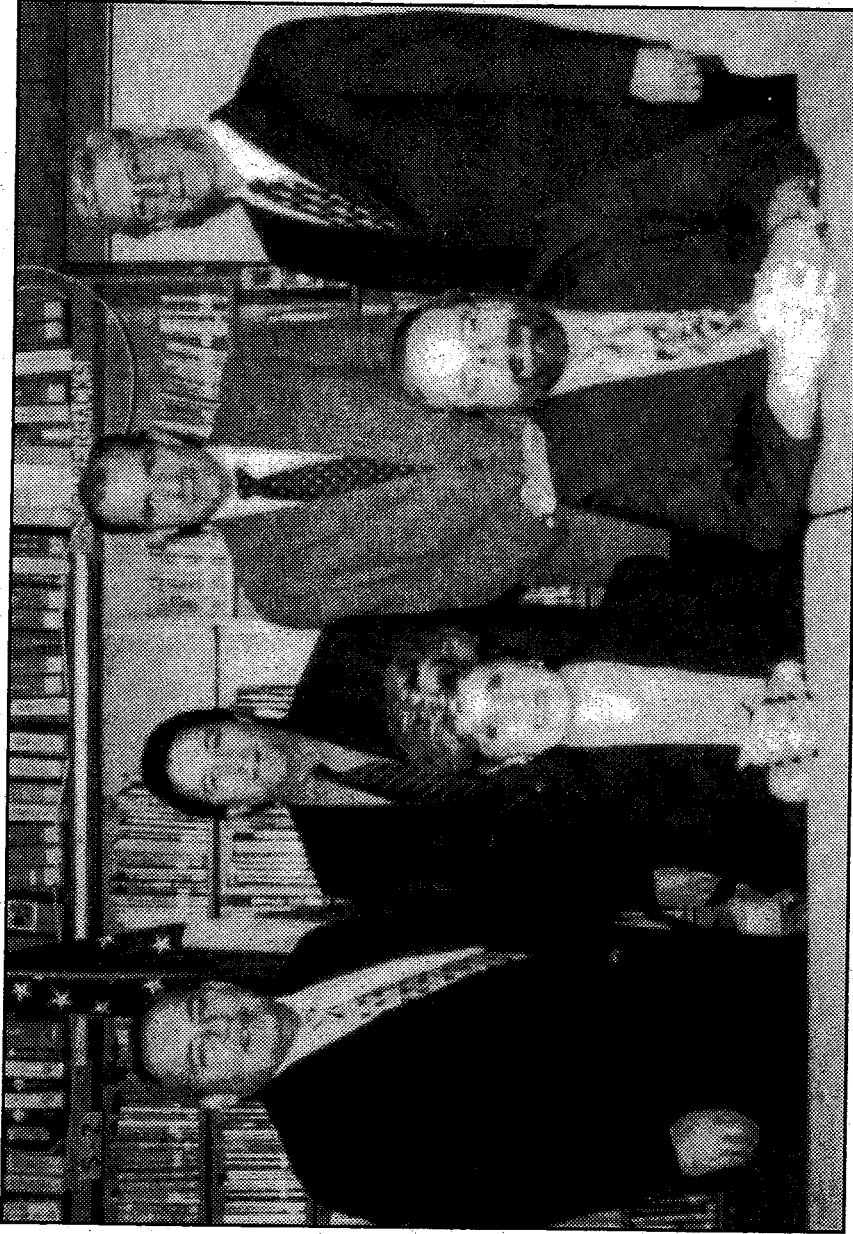

Standing (left to right): Thomas Galgano, Trustee; * Richard Eisenberg, Vice President;
Lawrence R. McGoldrick, Superintendent of Schools; William Gauger, Trustee
Seated (left to right): * Leanore Egan, President; * Andrew Walters, Trustee

*Also serves on the High School Board

School Telephone Directory

Main Office: Washington Avenue School

Superintendent 285-9881
 Business Office 285-9880
 Curriculum Office 285-9833
 Superintendent FAX 285-9839
 Washington Avenue FAX 285-8742

Clear Stream Avenue School

Principal's Office 872-4333
 Nurse's Office 872-4336
 FAX 872-1205

Forest Road School

Principal's Office 791-6134
 Nurse's Office 791-6790
 FAX 792-2931

Shaw Avenue School

Principal's Office 872-4320
 Nurse's Office 872-4327
 FAX 568-2436

Special Services

Computer Coordinator/AV Consultant... 872-4342
 Committee for Special Education,
 Chairperson 285-9820
 Sp. Ed. Parent Members Carolyn Lopardo 568-0355
 Iris Pinnaro 285-8236
 Mr. Winston Yarde 285-6567

Index

Board of Education	Page 2
District Staff	Page 4
Special Services and Programs	Page 5
General Information	Page 6
Weather Closings	Page 6
School Policies	Pages 7 & 8
Clear Stream PTA	Page 9
Forest Road PTA	Page 10
Shaw Avenue PTA	Page 11
Monthly Calendars	Pages 12 - 23
Valley Stream Council of PTA's & SEPTA	Page 22

Valley Stream High School District

Central High School 561-4400
 Memorial Junior High School 872-7700
 North High School 564-5500
 South High School 791-0300

Valley Stream School District No. 30 and Valley Stream Central High School District Valley Stream, New York

District No. 30 Schools

Shaw Avenue A
 Clear Stream Avenue B
 Forest Road C
 Washington Avenue D
 (District Office)

High Schools

North High 1
 Memorial Jr. High 2
 Central High 3
 South High 4

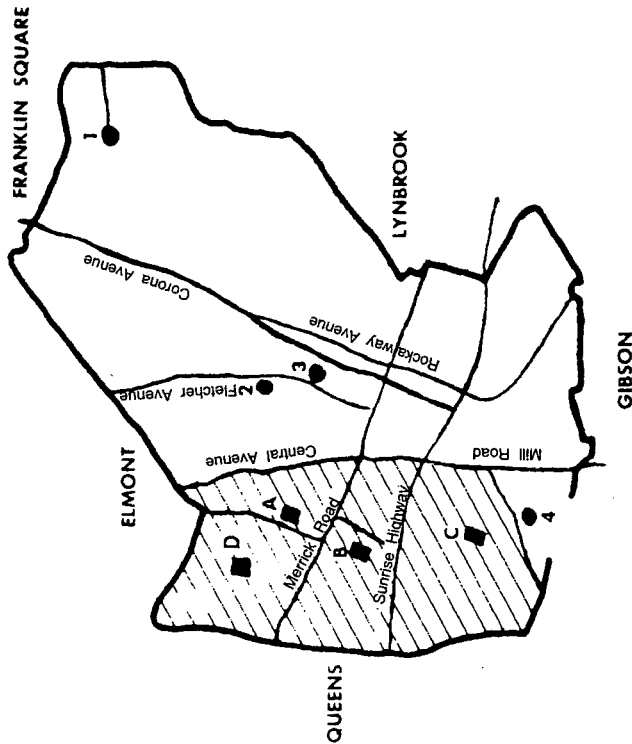

Calendar Preparation:

Carol Kingsley
 Angela Nicolini

Cover Design:

Christina Crauciuc, Francois Gaston, Jenny Weinbloom

School Administration

Dr. Jerry W. Shiveley, BOCES District Superintendent

Lawrence R. McGoldrick
Superintendent of Schools

Gene Nyitray
Assistant Superintendent of Schools

Helen C. DeSilva
Assistant to the Superintendent for Business

School Principals

Clear Stream Avenue School
Mr. Robert A. Cohen

Forest Road School
Mrs. Carol Kingsley

Shaw Avenue
Mr. Henry Mazer - *Principal*
Mr. Terence Ryan - *Assistant Principal*

Director of Facilities
Gregory Abbate

Secretary to Superintendent
Madelaine Furst

School Secretaries
Doreen Imbriani, Clear Stream Avenue
Angela Nicolini, Forest Road
Daryl Rossello, Shaw Avenue

Secretarial Staff
Marilyn Berkowitz
Carol Blankshine
Elaine Faling
Marilyn Russo
Anne O'Brien
Kathy Scuderi

School Nurses
Sally Kaplan
Forest Road

Alyce Gardner
Clear Stream Avenue

Sue Lombardo
Shaw Avenue

Special Services and Programs

It is the commitment of District Thirty to provide challenging and successful educational experiences for all children. Such challenges and successes will differ from child to child. The Office of Special Services and Programs is responsible for coordinating the various district-wide activities which promote school success for every child. Included in these activities are standardized testing, reading remediation, English as a Second Language, Gifted and Talented Education, speech and language therapy, health screening, counseling, and special education services.

Through the committee on Special Education (CSE) and the Committee on Pre-School Special Education (CPSE) children are assessed to determine eligibility for special education services. If a school-aged child is determined to have a disability, appropriate services will be provided within the consideration of the least restrictive environment. Appropriate services and instruction are determined by CSE/CPSE review and incorporated in the student's Individualized Education Program (IEP). Within District Thirty, students may receive IEP related services such as speech and language therapy, resource room, counseling, and occupational/physical therapy while participating in the regular education program. Learning Center (LC) classes provide instruction in reduced size learning environments with opportunities to be mainstreamed (as appropriate) into regular education classes. Some children because of their unique needs may benefit from out-of-district classes in neighboring school districts, BOCES programs, or private school placements. In any case, successfully meeting the needs of each child with a disability is the result of meaningful collaboration among parents, teachers, related services staff, administrators, and the CSE.

For preschool children between three and five years of age, the Committee on Pre-School Special Education (CPSE) process is designed to identify children who may be in need of special education services. Parents who suspect that their preschool child may not be attaining age-expected developmental behaviors are encouraged to contact the Director of Special Services for information about CPSE and the types of services available to eligible children. The Office of Special Services and Programs also coordinates with the Early Intervention Program of the Nassau County Department of Health to provide a smooth transition of services for infants and toddlers with disabilities to CPSE.

District Thirty also provides services to eligible children as specified by Section 504 of the Rehabilitation Act of 1973. The Director of Special Services and Programs is also the Section 504 Coordinator for the district.

The Office of Special Services and Programs is located at Washington Avenue Administrative Building; the phone number is 285-9833.

Elaine Faling
CSE/CPSE Secretary

Gene Nyitray
Director

Vandalism

Vandalism costs money. Help us to reduce this drain on our tax dollars by keeping a watchful eye on your local school. Perhaps you have noticed persons on school grounds who were behaving suspiciously or actually engaged in vandalism, but you have not known where to call.

To report school vandalism or suspicious activities at your school, call the Nassau County Emergency Number 911. Give the name of the school, its location, and a brief description of what is happening. A police car will be radio-dispatched to investigate, and appropriate school personnel will be alerted. School officials will prosecute offenders whenever possible and attempt to secure restitution for damages.

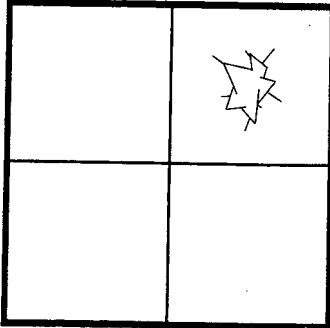

Please report any of these activities:

- persons on the roof of the school
- anyone throwing objects at windows
- someone shooting weapons of any kind
- any kind of fire on school grounds
- destruction of grounds, shrubbery, or facility
- anyone operating mini-bikes on playgrounds or driveway
- any other suspicious or criminal acts

Use of School Facilities

The Board of Education encourages the use of school facilities for community purposes when such use does not interfere with the scheduled school program. Organizations desiring to use school facilities should request an "Application for the Use of School Facilities" form from the principal of the school involved. Administrative rules and a statement of costs are explained on the application form.

School Visits

Parents are encouraged to visit school to meet the members of the professional staff, to examine the facilities, and instructional programs, and to share ideas. Those wishing to observe classes or to meet with staff members should arrange the visit in advance so that the time is appropriate and does not interfere with planned activities.

All visitors must register at the school office upon arrival, before visiting other parts of the building.

At dismissal times, parents picking up students are requested to meet them at a previously designated spot outside of the school. Dismissal exits have been assigned to classes in each building. Students are expected to leave the school building and school property in an orderly fashion at dismissal time each day. Such procedures are necessary to insure the safety of all students.

School Closings or Delayed Openings

Weather and other emergencies may warrant school closings or delayed openings. A delayed opening means students are expected to be at school at 10 AM. PTA Class Parents will be informed and will initiate telephone calls to inform parents in each class. NEWS 12 on Channel 12 will carry school closing information. Such school closings or delays will be also announced on the following local radio stations:

WCBS (AM)	88	WHLI (AM)	1100
WGBB (AM)	1240	WINS (AM)	1010
WGSM (AM)	740	WALK (FM)	97.5
		WALK (AM)	1370

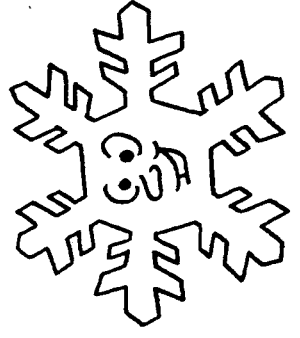

School Policies

School Hours for all Schools

Kindergarten to Grade 6, including Special Classes: 8:30 a.m. to 2:45 p.m. First bell rings at 8:20 a.m. Check with your school regarding availability of supervision for students who arrive before 8:20 a.m.

Breakfast

Students participating in the District Breakfast Program should not arrive before 7:50 a.m. **Supervision is not provided for students prior to that time.**

Lunch

Lunch is served beginning on the first day of school. Pupils may go home for lunch, bring lunch from home, or buy the school lunch in the cafeteria. **Students are not permitted to leave school for lunch unless picked up by a parent or authorized adult.** Monthly menus are provided. In case a child forgets or loses his/her lunch money, there is a charge system to cover the emergency. The secretary keeps the record of such charges and contacts the parents should a charge not be paid in a reasonable time. Students may purchase prepaid lunch tickets. Each ticket provides 20 meals, and is valid until June, or until all 20 meals are used. All tickets will remain with the Cafeteria Cashier.

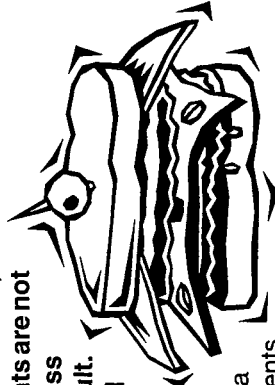

Snack Milk & Juice

Snack milk & juice are sold to all children beginning the first day of school. You will be notified as to exact date for payment. In case of a child's absence, no refund is made for period of less than a full week.

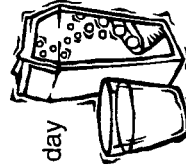

Absences

When your child has been absent, State law requires that he/she bring a note from you explaining the absences and the date(s) of absence(s). The note should be presented to the nurse **before** he/she goes to the classroom. Please be specific. Just saying, "he/she was ill", is not enough. Indicate whether it was "virus", "fever", "cold", etc.

A note is required for an absence due to a religious holiday. A note is required for any tardiness, giving the reason. If your child contacts a contagious disease,

such as mumps, measles, etc., please phone the school nurse so that she can alert the parents in your child's class that their children have been exposed. Be sure to keep the emergency card up to date so that we will know whom to call should your child become ill and have to go home.

Noon Hour Rules

Students who repeatedly misbehave in the cafeteria, auditorium, or on the playground during the noon hour, may be excluded from staying in school for lunch for a few days. If you receive such a note from the principal/teacher, we would appreciate your cooperation. Whether or not a parent is home during the noon hour has no bearing on this exclusion.

Exits and Entrances

Your child's class is assigned a specific exit and entrance to use. You will thus know where to meet him/her when you come to pick up. Parents picking up children are asked to meet them at the exit, **not the classroom.** Parents must wait outside the school at dismissal time.

Class Interruptions

No unnecessary interruptions of classes are allowed once the day's sessions have begun. When your child forgets a book, homework, sneakers, lunch money, etc., please bring these to the office. All pupils are instructed to check with the office at lunch time for such forgotten items. In the interest of the child's all-round education, we urge you not to make a practice of bringing forgotten items to school. The child should be developing his/her own sense of responsibility for these things.

Physical Education Attire and Sneakers

Boys and girls are required to wear appropriate attire and sneakers on assigned gym days. **NO ONE IS ALLOWED ON THE GYM FLOOR WITHOUT SNEAKERS.**

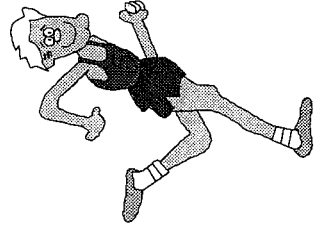

School Policies

Appointments with Teachers

In order that pupils' class time be used to the fullest advantage, we request that parents do not seek conferences with teachers during school hours. If you wish a conference, please make an appointment to see the teacher after school. Teachers are available for such conferences every day except Wednesdays and Fridays.

Bicycles

NO bicycles are allowed at either Forest Road or Clear Stream Avenue Schools because no child lives far enough from the school to make them necessary. They are allowed at Shaw, but are restricted to pupils in grades 4, 5, and 6 who live NORTH OF FOSTER AVENUE. **Bicycle operators must wear safety helmets.** All must have a lock and chain for safety purposes.

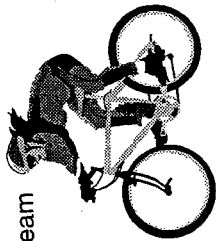

Gifts to Teachers Prohibited

The policy of the school district which became effective January 1956, is to prohibit the acceptance of gifts by faculty members on school premises, and to prohibit the solicitation of funds for personal gifts purposes, by any person, or persons, on the premises.

In-Day Program

In inclement weather, there is an in-day program of motion pictures or quiet games provided for those pupils who eat in the cafeteria. Pupils who go home to lunch are not allowed to participate in this program because of space limitations, so we ask parents to return these pupils to school on such days just in time for the afternoon session - not before five minutes prior to their scheduled lunch time.

Homework Requirements

Classroom learning is improved through effective homework assignments. Homework may include review, reinforcement, reading in preparation for classroom discussion, analysis and research. Homework helps students establish



work habits which will influence their use of time throughout life. Homework is required of all pupils, but it will vary from day to day. First and second grade pupils may have fifteen to twenty minutes of homework per day, while third and fourth grade pupils are likely to have thirty to forty minutes. Fifth and sixth graders are expected to devote as much as an hour to homework.

Students should require little if any help from parents in completing assignments. However, parents may assist students by insuring that they have a quiet, comfortable place to work.

Lost and Found

Unmarked articles lost by pupils are placed in the Lost-and-Found, which is in the Nurse's Office at Clear Stream, Shaw and Forest. Such articles, if not claimed at the end of the school year, are given to a charitable organization. However, any article bearing a child's name is returned directly to him/her. Please place your child's name on all his/her belongings.

Assemblies

When your child's class puts on an assembly program, we welcome your attendance, but we do ask you not to bring pre-school children. As much as we realize that it is a thrill for them to see older siblings perform, they are often distracting to all concerned. Picture taking or video taping are not allowed without prior approval.

Medication

When it is necessary for the child to take internal medication during school hours, the nurse will cooperate with the family physician and the parents. The parent must submit a written request to the Nurse with a written request from the family physician indicating the frequency and dosage of a prescribed medication. Then the school nurse will administer this medication during the school hours. Under no circumstances will a child be permitted to carry or to take medication by himself or herself.

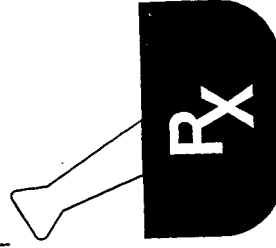

CLEAR STREAM AVENUE PARENT TEACHER ASSOCIATION 1999-2000

ELECTED OFFICERS

Co-President
 Co-President
 1st VP - Programs
 2nd VP-Pre-school
 3rd VP-Ways & Means
 Honorary Vice President
 Treasurer
 Recording Secretary
 Corresponding Secretary
 Membership
 Delegates to Council
 Teacher Delegate
 Past President

TELEPHONE

285-3574
 285-5675
 285-6639
 285-7051
 872-1380
 872-4333
 561-1906
 872-2098
 872-9627
 825-5762
 285-6690
 285-8626
 Faculty
 Faculty

SPECIAL COMMITTEE CHAIRPERSONS

Book Fair
 Breakfast w/Santa
 Candy Sale
 Cupcake Sale
 Fashion Show
 Father's Day Boutique
 Fingerprinting
 Holiday Boutique
 Kids Night Out
 Parent/Child Night
 PARP
 Plant Sale
 Reflections
 School Pictures
 Staff Recognition
 Supermarket "Zingo"
 Sweetheart Dance
 T-Shirt Sale
 Volunteer Appreciation

Penny Perziotte
 Valerie Cassano
 Marie Endrich
 Tina Cutrone
 Tina Cutrone
 Jovita Sabenicio
 Nancy Seifer
 Maryanne Valenti
 Judy Taleirco
 Maria Laudani
 Rosanna Schinco
 Tina Cutrone
 Nancy Seifer
 Mary Breuer
 Rosanna Schinco
 Grace Porti
 Cathy Mule'
 Donna Hansen
 Valerie Garcia
 Cathy Mule'
 Jane Spezio
 Pam Palaez
 Lisa Rostrom
 Ruth Palozzolo
 Valerie Garcia
 Carolyn Russo
 Toni Steenbeek
 Marie Endrich
 Grace Porti
 Candice Steur
 Jovita Sabenicio
 Denise Rodriguez
 Judy Taleirco
 Candice Steur
 Rosemary D'Ornellas
 Rosanna Schinco
 Patricia Raykowski
 Marissa Makram

285-8313
 561-6925
 561-1906
 285-7051
 285-7051
 285-3476
 568-9162
 825-0332
 561-3655
 825-7649
 561-4021
 285-7051
 568-9162
 285-4173
 561-4021
 872-9627
 872-2098
 285-0903
 285-6639
 872-2098
 825-5762
 285-7339
 561-8798
 285-4539
 285-6639
 561-5022
 285-5843
 561-1906
 872-9627
 285-4547
 285-3476
 285-8451
 561-3655
 285-4547
 872-9313
 561-4021
 285-5675
 285-3574

EXECUTIVE BOARD STANDING COMMITTEE CHAIRPERSONS

Arts & Flyers
 Auditing
 Birthday Calendar
 Cultural Arts
 Hospitality
 Legislation
 Nutrition
 Parent Awareness
 Procedures
 Publicity/Historian
 Safety
 School & Community
 Scope
 SEPTA
 Streamer

825-5029
 285-7068
 825-5762
 Faculty
 872-8229
 561-5022
 568-9162
 825-0332
 872-3224
 285-5843
 285-7068
 872-2098
 305-6683
 872-3224
 825-5029
 285-8182
 285-6639
 285-4692

James Johnson
 Maryanne Lanz
 Jane Spezio
 Mary Maclean
 Joanne Novello
 Carolyn Russo
 Nancy Seifer
 Maryanne Valenti
 Rosemary Miller
 Toni Steenbeek
 Maryann Lanz
 Executive Board
 Cathy Mule'
 Mirtho Denis
 Rosemary Miller
 James Johnson
 Dahreis Scott
 Valerie Garcia
 Michele Hill

FOREST ROAD PARENT TEACHER ASSOCIATION 1999-2000

POSITION	ELECTED OFFICERS	TELEPHONE	Programming Committees	
Co-Presidents	Elly Haber	791-1293	Committee Chairperson	Wendie Ciorciari 791-4266
1st Vice President	Andrea Bretscher	791-2248	Field Day	Andrea Bretscher 791-2248
2nd Vice President	Brigette LaPorte	791-6698	PARP	Dina Ciullo 792-0216
3rd Honorary Vice President	Ways & Means	791-2971	Pre-School	Brigette LaPorte 791-6698
Treasurer	Helene Steiner	791-6134	Reflections	Jill Cohen 791-3407
Rec. Secretary	Carol Kingsley	791-8425	Sports Night	Louise Edman 791-7331
Financial Secretary	Helene Harris	791-3889		Maria Shea 791-1606
Corr. Secretary	Sue Pepper	791-1606		Rochelle Gendelman 791-9146
Teacher Representatives	Maria Shea	791-4574		Charlotte Lurie 791-8662
	Karen McDaniel	791-6134		Julie Olson 792-9629
	Linda Kessler	791-6134		Elly Haber 791-1293
	Jodi Fine	791-6134		Sharon Hirth 791-5142
				Alicia Matthew 791-1831

EXECUTIVE BOARD COMMITTEE CHAIRPERSONS

Administrative Committees	Fundraising Committees
Delegate to Council	Chairpersons
Banking Co-Ordinators	Book Fair/Winter
Class Parent Co-Ordinators	Book Fair/Summer
Flyers/Historian	Candy & Gift Wrap Sale
Hospitality	Carnival
Legislation	Chinese Auction
Newsletter	Fashion Show
Nutrition Reps.	Holiday Boutique
Publicity	Plant Sale
Safety	Pumpkin Sale
School Board Reps.	
School Pictures	
SEPTA Reps.	
6th Grade Yearbook	
Staff Recognition	
Volunteer Appreciation	

SHAW AVENUE PARENT TEACHER ASSOCIATION 1999-2000

POSITION	ELECTED OFFICERS	TELEPHONE	Gift Wrap Sale	PTA EXECUTIVE BOARD	
President	Kathy Vagnone	825-3849	Grade Reprs. Coordinator	Mary Aumuller	285-0439
1st Vice President	Vivian Rainone	872-1132	Holiday Boutique	Rosann Colucci	561-3602
2nd Vice President	Mary Aumuller	285-0439	Hospitality	Rose Walsh	568-0383
Honorary Vice President	Henry Mazer	872-4320	Installation Dinner	Debbie Walsh	561-1387
Treasurer	Marybeth Cully	825-2935	Jr. Bowling	Michael Antoniato	596-4457
Assistant Treasurer	Tara Starna	561-3613	Labels for Education	Tom Bannon	285-6620
Rec. Secretary	Rosann Colucci	561-3602	Ladies Volleyball	Donna Mazzeo	285-5355
Corr. Secretary	Barbara DiMaggio	825-6227	Legislation	Lorraine Brooks	561-1902
Delegate to Council	Marianne Esterez	285-3743	Membership	Dolores Jacobsen	568-9894
	Lisa Friscia	256-0034	Mothers Day Boutique	Dolores Jacobsen	568-9894
Teacher Delegate	Nancy Bart	872-4320	Newsletter ("Shaw Biz")	Eileen Ortiz	825-0246
			New Parents Tea	Betty Acosta	568-9820
			Nutrition	Ken Park	285-1159
			Parent/Child Dances	PTA EXECUTIVE BOARD	
			PARP	PTA EXECUTIVE BOARD	
			Public Relations	Eileen Ortiz	825-0246
			Pumpkin Patch	Betty Acosta	568-9820
			Reflections	Dolores Jacobsen	568-9894
			School Board Rep.	Rosann Colucci	561-3602
			School-wide Picnic	Marybeth Cully	825-2935
			School Pictures	Janet Maci	561-0588
			SCOPE	Marianne Estevez	285-3743
			SEPTA	Chris Vessely	285-5736
			Sixth Grade T-Shirts	Executive Board	
			Sixth Grade Yearbook	Lisa Friscia	256-0034
			Teacher/Staff Recognition	Vivian Rainone	872-1132
			T-Shirt/Sweatshirt Sale	Petra Hurney	360-0800
				Eileen Brady	561-7558
				Debbie Dolan	872-0415
				Rosemarie Rallo	285-7483
				Vivian Rainone	285-6005
				Rose Stroehleim	872-1132
					568-1522

COMMITTEE CHAIRPERSONS

Arts In Education	Paul Farinacci	872-4320
Banking	Judy Post	872-4320
Birthday Calendar	Rosann Colucci	561-3602
Book Fair	Executive Board	
Breakfast w/Santa	Linda Pandolfi	285-8416
Cupcake Sale	Tara Starna	561-3613
Dance and Twirl Information	PTA EXECUTIVE BOARD	
Dance and Twirl Registration	Rosann Colucci	561-3602
Family Fun Night	Joanne Zdanko	568-0498
Fashion Show	Sandi Procida	825-7987
Father's Day Boutique	Executive Board	
Field Day/Play Day	Mary Aumuller	285-0439
Field Day/Play Day T-Shirts	Debbie Dolan	285-7483
Fingerprinting	Linda Robles	561-6591
	Donna Petrauskas	561-3540
	Genine Iadevaio	285-7471
	Marybeth Cully	825-2935
	Marybeth Cully	825-2935
	Tara Starna	561-3613

SEPTEMBER 1999

October
 Su M Tu W Th F Sa
 3 4 5 6 7 8 9
 10 11 12 13 14 15 16
 17 18 19 20 21 22 23
 24 25 26 27 28 29 30
 31

August
 Su M Tu W Th F Sa
 1 2 3 4 5 6 7
 8 9 10 11 12 13 14
 15 16 17 18 19 20 21
 22 23 24 25 26 27 28
 29 30 31

SUNDAY	MONDAY	TUESDAY	WEDNESDAY	THURSDAY	FRIDAY	SATURDAY
			1	2	3	4
5	6 LABOR DAY	7 Superintendent's Conference Day No School for Students VSCHSD Bd. of Ed. Comm. Mtg. 8 P.M.	8 SCHOOLS OPEN Clear Stream Coffee, Tea, & Treats 8:30 A.M. (Kindergarten Parents)	9	10 Forest PTA New Parents Tea 9 A.M.	11
12	13 V.S. SEPTA Mtg. Mem. JHS 8 P.M. Dist. 30 Bd. of Ed. Comm. Mtg. 8 P.M.	14 PRIMARY ELECTION 5:30 A.M. - 9 P.M. Clear Stream/Forest/Shaw (Schools in Session) Forest PTA Exec. Bd. Mtg. 8:30 A.M. Clear Stream Parent Mtg. 7:30 P.M. VSCHSD Bd. of Ed. Mtg. 8:30 P.M.	15 Shaw New Parents Tea 8:30 A.M. - 11 A.M.	16 Shaw Jr. Bowling Registration 2:45 P.M. Clear Stream/Forest/Shaw Meet The Teacher Night 7:30 P.M.	17	18
19	20 YOM KIPPLUR Schools Closed	21 Shaw PTA Meeting 8 P.M.	22 Shaw Jr. Bowling Registration 2:45 P.M. Clear Stream Fingerprinting Clear Stream New Parents Mtg. 7 P.M. Forest PTA Class Parent Mtg. 7:30 P.M./Gen. Mtg. 8 P.M. Clear Stream PTA Mtg. 8 P.M.	23 Forest PTA Candy/Gift Wrap Sale Begins Shaw T-Shirt Sale 2:45 P.M. Nassau District President's Rap	24 Forest Road PTA School Pictures Shaw Dance/Twirl Reg. 2:45 P.M.	25
26	27 Dist. 30 Bd. of Ed. Mtg. 8 P.M.	28	29 Shaw Gift Wrap Sale Begins	30 Clear Stream T-Shirt Sale 2:30 P.M.		SHADED BOX INDICATES SCHOOL IS CLOSED

OCTOBER 1999

September

Su	M	Tu	W	Th	F	Sa
5	6	7	8	9	10	11
12	13	14	15	16	17	18
19	20	21	22	23	24	25
26	27	28	29	30		

November

Su	M	Tu	W	Th	F	Sa
7	8	9	10	11	12	13
14	15	16	17	18	19	20
21	22	23	24	25	26	27
28	29	30				

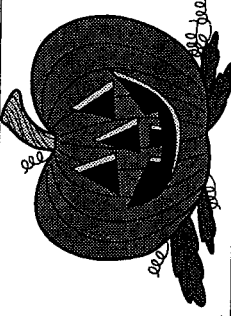
SUNDAY	MONDAY	TUESDAY	WEDNESDAY	THURSDAY	FRIDAY	SATURDAY
SHADED BOX INDICATES SCHOOL IS CLOSED						
3	4	5	6	7	8	9
	Forest Gr. 6 Outdoor Ed. Program	Forest Gr. 6 Outdoor Ed. Program	Shaw School Pictures	Forest Candy/Gift Wrap Sale Ends	Clear Stream Candy Sale Begins Clear Stream School Pictures	Clear Stream Candy Sale Begins Clear Stream School Pictures
	V.S. PTA Council Mtg. Howell Rd. 7:30 P.M.	V.S. PTA Council Mtg. Howell Rd. 7:30 P.M.				
10	11	12	13	14	15	16
	COLUMBUS DAY (Schools Closed)	Forest PTA Exec. Bd. Mtg. 8:30 A.M. Shaw Gr. 6 Outdoor Ed. Program	Forest PTA Exec. Bd. Mtg. 8:30 A.M. Shaw Gr. 6 Outdoor Ed. Program		Breakfast w/Supt. 8:30 A.M.	Breakfast w/Supt. 8:30 A.M.
		Shaw Banking Reg. Begins Nassau Dist. PTA Resolutions Workshop V.S. PTA Bd. of Ed. Mtg. 8:30 P.M.	Shaw Banking Reg. Begins Nassau Dist. PTA Resolutions Workshop V.S. PTA Bd. of Ed. Mtg. 8:30 P.M.	Shaw Twirl Begins		
17	18	19	20	21	22	23
	Shaw Gr. 6 Outdoor Ed. Program Clear Stream Reflections Begins Shaw Dance Begins V.S. SEPTA Mtg. Mem. JHS 8 P.M. Dist. 30 Bd. of Ed. Comm. Mtg. 8 P.M.	Shaw Gr. 6 Outdoor Ed. Program Clear Stream Gr. 6 Outdoor Ed. Program Shaw PTA Meeting	Shaw Gr. 6 Outdoor Ed. Program Clear Stream Gr. 6 Outdoor Ed. Program	Forest PTA Fashion Show 7:30 P.M.	Clear Stream Candy Sale Ends Forest PTA Pumpkin Sale Shaw Kindergarten - Pumpkin Patch	Clear Stream Candy Sale Ends Forest PTA Pumpkin Sale Shaw Kindergarten - Pumpkin Patch
24	25	26	27	28	29	30
	Dist. 30 Bd. of Ed. Mtg. 8 P.M.	Clear Stream Pumpkin Patch Shaw Banking Reg. Ends	Shaw Fingerprinting Pumpkin Patch (All Day) Nassau District Fall Conference Forest PTA Gen. Mtg. 8 P.M.	Clear Stream Reflections Ends	Forest Gr. 6 Halloween Party Clear Stream Gr. 5 & 6 Halloween Party 5:30 P.M. - 7:30 P.M.	Forest Gr. 6 Halloween Party Clear Stream Gr. 5 & 6 Halloween Party 5:30 P.M. - 7:30 P.M.
	Daylight Savings Time Ends					
	HALLOWEEN 31					

NOVEMBER 1999

December

Su	M	Tu	W	Th	F	Sa
5	6	7	8	9	10	11
12	13	14	15	16	17	18
19	20	21	22	23	24	25
26	27	28	29	30	31	

October

Su	M	Tu	W	Th	F	Sa
3	4	5	6	7	8	9
10	11	12	13	14	15	16
17	18	19	20	21	22	23
24	25	26	27	28	29	30
31						

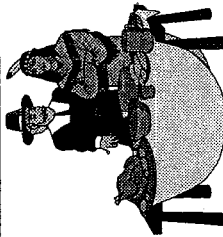
SUNDAY	MONDAY	TUESDAY	WEDNESDAY	THURSDAY	FRIDAY	SATURDAY
1 	2 Election Day 5:30 A.M. - 9 P.M. Clear Stream/Forest/Shaw (Schools are in session) Shaw Banking Gr. K - 2 VSCHSD Bd. of Ed. Comm. Mtg. 8 P.M.	3 Election Day 5:30 A.M. - 9 P.M. Clear Stream/Forest/Shaw (Schools are in session)	4 Shaw Book Fair 9 A.M. - 2 P.M. Shaw Banking Gr. 3 - 6 LC IV	5 Shaw Book Fair 9 A.M. - 2 P.M. 5 P.M. - 9 P.M. Forest Picture Retake	6 V.S. Dist. 30 Building Inspection	
7 N.Y.S. PTA Convention Syracuse	8 Shaw Reflections Workshop Gr. K - 2 VS SEPTA Mtg. Mem. JHS 8 P.M.	9 Forest PTA Exec. Bd. Mtg. 8:30 A.M. VSCHSD Bd. of Ed. Mtg. 8:30 PM	10 Clear Stream PTA Gen. Mtg. 9 A.M.	11 VETERANS DAY Schools Closed	12 Shaw Reflections Workshop Gr. 3 - 4	13 N.Y.S. PTA Convention Syracuse.
14 N.Y.S. PTA Convention Syracuse	15 American Education Week Shaw Reflections Workshop Gr. 3 - 4 Dist. 30 Bd. of Ed. Comm. Mtg. 8 P.M.	16 American Education Week Shaw Reflections Workshop Gr. 3 - 4 Clear Stream Book Fair Shaw Banking Gr. K - 2 Shaw PTA Mtg. 8 P.M.	17 Clear Stream Pre School Mtg. 1:30 P.M. Clear Stream Book Fair Forest PTA Gen. Mtg. 8 P.M.	18 Shaw Reflections Workshop Gr. 5 - 6 Clear Stream Picture Retake Shaw Banking Gr. 3 - 6 LC IV	19 Shaw Breakfast w/Santa ticket sale 2:45 P.M. Clear Stream Reflections Night 7:30 P.M.	20 VSCHSD Building Inspection 8 A.M.
21	22 Dist. 30 Bd. of Ed. Mtg. 8 P.M.	23 Thanksgiving Breakfast Shaw Picture Retake	24 Thanksgiving Recess Schools Closed	25 THANKSGIVING DAY Thanksgiving Recess Schools Closed	26 Thanksgiving Recess Schools Closed	27
28 Forest PTA Reflections Begins	29	30				SHADED BOX INDICATES SCHOOL IS CLOSED

DECEMBER 1999

November

Su	M	Tu	W	Th	F	Sa
7	8	9	10	11	12	13
14	15	16	17	18	19	20
21	22	23	24	25	26	27
28	29	30				

January

Su	M	Tu	W	Th	F	Sa
2	3	4	5	6	7	8
9	10	11	12	13	14	15
16	17	18	19	20	21	22
23	24	25	26	27	28	29
30	31					

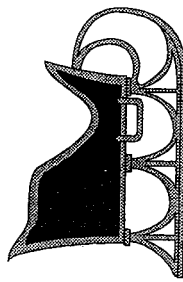
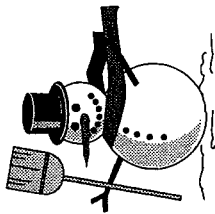
SUNDAY	MONDAY	TUESDAY	WEDNESDAY	THURSDAY	FRIDAY	SATURDAY
5 	6 Shaw Reflections Ends Nassau District Presidents/Principals Dinner 7 P.M.	7  Shaw Banking Gr. K - 2 VSCHSD Bd. of Ed. Comm. Mtg. 8 P.M.	1 Forest PTA Holiday Boutique 9 A.M. - 2:30 P.M.	2 Clear Stream/Forest/Shaw PTA Holiday Boutique 9 A.M. - 2:30 P.M.	3 Clear Stream/Shaw PTA Holiday Boutique 9 A.M. - 2:30 P.M.	4 VSCHSD Building Inspection 8 A.M.
12	13 V.S. PTA Council Mtg. 7:30 P.M. W.L. Buck Dist. 30 Bd. of Ed. Comm. Mtg. 8 P.M.	14 Forest PTA Exec. Bd. Mtg. 8:30 A.M. Forest Winter Concert 7:30 P.M. VSCHSD Bd. of Ed. Mtg. 8:30 P.M.	8 Shaw Winter Concert 7:30 P.M.	9 Shaw Banking Gr. 3 - 6 LC IV Clear Stream PTA Exec. Bd. Mtg. 7:15 P.M. Gen. Mtg. 8 P.M.	10 Shaw No Twirling	11 Clear Stream/Shaw Breakfast w/Santa 10 A.M. - 12 P.M.
19	20 Forest PTA Reflections Ends Dist. 30 Bd. of Ed. Mtg. 8 P.M.	21 Shaw Banking Gr. K - 2	22 CHRISTMAS/NEW YEARS RECESS Schools Closed	23 Clear Stream Holiday Parties Shaw Banking Gr. 3 - 6 LC IV	24 Clear Stream Winter Concert 7:30 P.M.	25
26	27 CHRISTMAS/NEW YEARS RECESS Schools Closed	28 CHRISTMAS/NEW YEARS RECESS Schools Closed	29 CHRISTMAS/NEW YEARS RECESS Schools Closed	30	31	SHADED BOX INDICATES SCHOOL IS CLOSED

JANUARY 2000

December
 Su M Tu W Th F Sa
 5 6 7 8 9 10 11
 12 13 14 15 16 17 18
 19 20 21 22 23 24 25
 26 27 28 29 30 31

February
 Su M Tu W Th F Sa
 6 7 8 9 10 11 12
 13 14 15 16 17 18 19
 20 21 22 23 24 25 26
 27 28 29

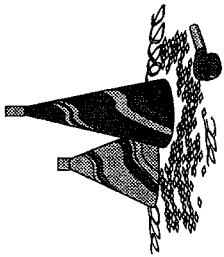
SUNDAY	MONDAY	TUESDAY	WEDNESDAY	THURSDAY	FRIDAY	SATURDAY	
SHADED BOX INDICATES SCHOOL IS CLOSED							1 NEW YEAR'S DAY
2	3 Schools Reopen	4 Shaw Banking Gr. K - 2 VSCHSD Bd. of Ed. Comm. Mtg. 8 P.M.	5 Shaw Banking Gr. 3 - 6 LC IV	6	7 Breakfast w/Supt. Shaw 8:30 A.M. Clear Stream PARRP Begins Clear Stream Pajama Party 7 P.M. - 8 P.M.	8	
9	10 SEPTA Mtg. Mem. JHS 8 P.M.	11 Forest PTA Exec. Bd. Mtg. 8:30 A.M. Shaw PTA Mtg./Reflections Awards Night 7:30 P.M. VSCHSD Bd. of Ed. Mtg. 8:30 P.M.	12 Clear Stream PTA Gen. Mtg. 9 A.M. Nassau District PTA Nominations & Elections Workshop	13	14	15	
16	17 MARTIN LUTHER KING DAY (Schools Closed)	18 Shaw Banking Gr. K - 2	19	20 Shaw Banking Gr. 3 - 6 LC IV	21 Forest PTA Kids Sports Night Gr. 4-5-6 7 P.M. - 9 P.M.	22	
23	24 Dist. 30 Bd. of Ed. Comm. Mtg. 8 P.M. Dist. 30 Bd. of Ed. Mtg. 8 P.M.	25 Forest PTA PARRP Begins Shaw Cupcake Sale	26 Forest PTA Book Fair	27 Forest PTA Gen. Mtg. 8:30 A.M. Forest PTA Book Fair	28 Tentative Superintendent's Conference Day For Faculty/Staff No School for Students	29	
30	31						

FEBRUARY 2000

January

Su	M	Tu	W	Th	F	Sa
2	3	4	5	6	7	8
9	10	11	12	13	14	15
16	17	18	19	20	21	22
23	24	25	26	27	28	29
30	31					

March

Su	M	Tu	W	Th	F	Sa
5	6	7	8	9	10	11
12	13	14	15	16	17	18
19	20	21	22	23	24	25
26	27	28	29	30	31	

SUNDAY	MONDAY	TUESDAY	WEDNESDAY	THURSDAY	FRIDAY	SATURDAY
6 SHADED BOX INDICATES SCHOOL IS CLOSED	7 V.S. PTA Council Mtg. Forest 7:30 P.M.	8 Forest PTA Exec. Bd. Mtg. 8:30 A.M. Forest PARP Ends V.S. PTA Bd. of Ed. Mtg. 8:30 PM	9 Clear Stream Cupcake Sale Nassau District PTA President's Rap	10 Shaw Pre-School Mtg. 3 P.M. - 4 P.M.	11 Shaw No Twirling Shaw Family Fun Fair 7 P.M. - 10 P.M.	12 LINCOLN'S BIRTHDAY
13	14 Dist. 30 Bd. of Ed. Comm. Mtg. 8 P.M. V.S. SEPTA Mtg. Mem. JHS 8 P.M.	15 Shaw PTA Meeting Shaw Banking Gr. K - 2	16 Shaw Spring Candy Sale Begins Clear Stream Exec. Bd. Mtg. 7:15 P.M. Gen. Mtg. 8 P.M. Forest PTA Gen. Mtg. 8 P.M.	17 Shaw Banking Gr. 3 - 6 LC IV	18	19
20	21 Winter Recess - Schools Closed	22 WASHINGTON'S BIRTHDAY	23	24	25	26
27	28 Dist. 30 Bd. of Ed. Mtg. 8 PM	29 PTA Day in Albany				



MARCH 2000

February
 Su M Tu W Th F Sa
 6 7 8 9 10 11 12
 13 14 15 16 17 18 19
 20 21 22 23 24 25 26
 27 28 29

April
 Su M Tu W Th F Sa
 2 3 4 5 6 7 8
 9 10 11 12 13 14 15
 16 17 18 19 20 21 22
 23 24 25 26 27 28 29
 30

SUNDAY	MONDAY	TUESDAY	WEDNESDAY	THURSDAY	FRIDAY	SATURDAY
			1 Shaw Spring Candy Sale Ends	2	3 Shaw No Twirling Clear Stream Parent/Child Night 7 P.M.	4
	6 Shaw PARP Begins Shaw No Dance	7 Shaw Banking Gr. K - 2 Forest PTA Exec. Bd. Mtg. 8:30 A.M. VSCHSD Bd. of Ed. Comm. Mtg. 8 P.M.	8 Clear Stream PTA Exec. Bd. Mtg. 7:15 P.M. Gen. Mtg. 8 P.M.	9 Shaw Banking Gr. 3 - 6 LC IV	10	11 Nassau District Legislative Brunch Forest PTA Carnival 11 A.M. - 3 P.M.
12	13 SEPTA Mtg. Mem. JHS 8 P.M.	14 Forest Pre-School Mtg. 3 P.M. - 4 P.M. Shaw PTA Mtg. 8 P.M. VSCHSD Bd. of Ed. Mtg. 8:30 P.M.	15 Clear Stream Pre-school Mtg. 1:30 P.M.	16 Clear Stream Fashion Show "Russo's on the Bay" 7:30 P.M.	17	18 V.S. PTA Council Legislative Breakfast Mem. JHS 9:30 A.M. - 11:30 A.M.
19	20 Dist. 30 Bd. of Ed. Comm. Mtg. 8 P.M.	21 Shaw Banking Gr. K - 2 Clear Stream Science Fair 7:30 P.M.	22 Forest Science Fair 7:30 P.M.	23 Shaw Banking Gr. 3 - 6 LC IV Shaw Pre-School Mtg. 3 P.M. - 4 P.M. Forest PTA Gen. Mtg. & Electronics 7 P.M. Forest PTA Chinese Auction 7:30 P.M. Shaw Science Fair 7:30 P.M.	24 Breakfast w/Supt. Forest 8:30 A.M. Shaw Spring Book Fair 9 A.M. - 2:30 P.M. 5 P.M.-9 P.M.	25
26	27 Dist. 30 Bd. of Ed. Mtg. 8 P.M.	28	29	30	31	SHADED BOX INDICATES SCHOOL IS CLOSED



APRIL 2000

March
Su M Tu W Th F Sa
5 6 7 8 9 10 11
12 13 14 15 16 17 18
19 20 21 22 23 24 25
26 27 28 29 30 31

May
Su M Tu W Th F Sa
1 2 3 4 5 6
7 8 9 10 11 12 13
14 15 16 17 18 19 20
21 22 23 24 25 26 27
28 29 30 31

SUNDAY	MONDAY	TUESDAY	WEDNESDAY	THURSDAY	FRIDAY	SATURDAY
1 SHADED BOX INDICATES SCHOOL IS CLOSED	2 	3 Forest PTA Exec. Bd. Mtg. 8:30 A.M.	4 V.S. PTA Council Mtg. 7:30 P.M. Dever	5 V.S. PTA Council Mtg. 7:30 P.M. Dever	6 V.S. PTA Council Mtg. 7:30 P.M. Dever	7 Clear Stream Kids Night Out 7 P.M.
8 Daylight Savings Time Begins	9 V.S. PTA Council Mtg. 7:30 P.M. Dever	10 V.S. PTA Council Mtg. 7:30 P.M. Dever	11 KINDERGARTEN REGISTRATION (All Schools) 9 A.M. - 11 A.M.	12 Lights On For Education Mem. JHS 7:15 P.M. - 9:15 P.M.	13 Clear Stream Exec. Bd. Mtg. 7 P.M. Gen. Mtg. 7:30 P.M.	14 Clear Stream Kids Night Out 7 P.M.
15 Earth Day	16 Shaw PAPP Ends V. S. SEPTA Mtg. Mem. JHS 8 P.M. Dist. 30 Bd. of Ed. Comm. Mtg. 8 P.M.	17 Shaw PAPP Ends V. S. SEPTA Mtg. Mem. JHS 8 P.M. Dist. 30 Bd. of Ed. Comm. Mtg. 8 P.M.	18 Shaw PTA Mtg. 8 P.M. BOCES Budget Vote 7 P.M. w/Dist. 30 Bd. of Ed. Mtg. following.	19 Forest PTA Gen. Mtg. 8 P.M.	20 Shaw Banking Gr. K - 2 Shaw Spring Concert 7:30 P.M.	21 Clear Stream Spring Concert 7:30 P.M.
22 Earth Day	23 Spring Recess Schools Closed	24 Spring Recess Schools Closed	25 Spring Recess Schools Closed	26 Spring Recess Schools Closed	27 Spring Recess Schools Closed	28 Spring Recess Schools Closed
29	30	31				

MAY 2000

April

Su	M	Tu	W	Th	F	Sa
2	3	4	5	6	7	8
9	10	11	12	13	14	15
16	17	18	19	20	21	22
23	24	25	26	27	28	29
30						

June

Su	M	Tu	W	Th	F	Sa
4	5	6	7	8	9	10
11	12	13	14	15	16	17
18	19	20	21	22	23	24
25	26	27	28	29	30	

SUNDAY	MONDAY	TUESDAY	WEDNESDAY	THURSDAY	FRIDAY	SATURDAY
1 	1 VSCHSD Bd. of Ed. Comm. Mtg. 8 P.M.	2 Shaw Banking Gr. K - 2 Dist. 30 Budget Hearing Shaw 8 P.M.	3 Dist. 13 Budget Hearing Dever 8 P.M.	4 Shaw Banking Gr. 3 - 6 LC IV Dist. 24 Budget Hearing Buck 8:15 P.M.	5 Tots to Teens Central H.S. 7 P.M.	6
7	8 6th Gr. Parent Orientation Mem. JHS V.S. SEPTA Mtg. Mem. JHS 8 P.M.	9 Forest PTA Exec. Bd. Mtg. 8:30 A.M. Voter Registration 7-9 A.M. & 4-9 P.M. (All Schools) Clear Stream/Forest Pre-School Mtg. 7 P.M. VSCHSD Bd. of Ed. Mtg. 8:30 P.M.	10 Forest PTA Plant Sale Pre-Order Pick-Up	11 Shaw Mother's Day Boutique Forest PTA Plant Sale Clear Stream Exec. Bd. Mtg. 7:15 P.M. Gen. Mtg. 8 P.M.	12 Clear Stream/Forest PTA Plant Sale Shaw Mother's Day Dance 7:30 P.M.	13
14 Mother's Day	15	16 Shaw Banking Ends Gr. K - 2 Shaw PTA Volunteer Night 8 P.M. VOTING ALL SCHOOLS 7 A.M. - 10 P.M. DISTRICT ART EXHIBIT 7:30 P.M. - 9 P.M.	17 N.Y.S. Gr. 4 Mathematics Test	18 Shaw Banking Ends Gr. 3 - 6 LC IV	19 Clear Stream Staff Recognition Day Shaw Installation Dinner NYSSMA Solo Festival	20
21	22 Dist. 30 Bd. of Ed. Comm. Mtg. 8 P.M.	23 Forest PTA Installation Dinner 7:30 P.M. Nassau District Spring Conference	24	25	26	27
28	29 MEMORIAL DAY (Schools Closed) Memorial Day Parade 9 A.M.	30	31			SHADED BOX INDICATES SCHOOL IS CLOSED

JUNE 2000

May
Su M Tu W Th F Sa
1 2 3 4 5 6
7 8 9 10 11 12 13
14 15 16 17 18 19 20
21 22 23 24 25 26 27
28 29 30 31

July
Su M Tu W Th F Sa
2 3 4 5 6 7 8
9 10 11 12 13 14 15
16 17 18 19 20 21 22
23 24 25 26 27 28 29
30 31

SUNDAY	MONDAY	TUESDAY	WEDNESDAY	THURSDAY	FRIDAY	SATURDAY
4 SHADED BOX INDICATES SCHOOL IS CLOSED	5 V.S. PTA Council Mtg. 7:30 P.M. South H.S.	6 Forest PTA Staff Appreciation Luncheon Shaw PTA Social Mtg. 7 P.M. VSCHSD Bd. of Ed. Comm. Mtg. 8:00 P.M.	7 Clear Stream PTA Gen. Mtg. 9 A.M. Clear Stream PTA Installation Dinner 7 PM	8 Clear Stream PTA Volunteer Appreciation Breakfast 9 A.M. Shaw Father's Day Boutique	9 Forest PTA Volunteer Appreciation Breakfast 9 A.M.	10
11	12 V.S. SEPTA Mtg. Mem. JHS 8 P.M.	13 VSCHSD Bd. of Ed. Mtg. 8:30 P.M.	14 FLAG DAY	15 Forest PTA Summer Book Fair	16 Clear Stream Father's Day Boutique Forest PTA Summer Book Fair Clear Stream Sweetheart Dance 7:30 P.M. Shaw Father's Day Dance 7:30 P.M.	17
18 Father's Day	19 Dist. 30 Bd. of Ed. Comm. Mtg. 8 P.M.	20 V.S. SEPTA Mtg. Mem. JHS 8 P.M.	21 Clear Stream/Forest/Shaw 6th Grade Closing Exercises 8:15 PM	22 Clear Stream/Forest/Shaw Kindergarten Graduation 9 A.M. Shaw School-wide Picnic Clear Stream/Forest/Shaw 6th Gr. Parties 1-3 PM	23 Last Day of School	24
25	26 Dist. 30 Bd. of Ed. Mtg. 8 P.M.	27	28	29	30	31

SEPTA

Valley Stream Officers for 1999-2000

President: Dominique Wiener 825-4702
 Co-President: Anette Senacola 481-7716
 Vice Presidents: Robert Musmacher 568-9604
 Joanne Carmalleri 825-1668
 Josephine Centore 485-6411
 Treasurer: Melissa Gates 791-2516
 Rec. Secretary: Rose Barbaro 561-8018
 Correspond. Secty.: Pat Torres 561-3154
 Delegate to Council: Petra Hurney 561-7558
 Delegate to SEPTA/BOCES: Joanne Altrui 488-4255
 Past President: Robert Musmacher 568-9604

JULY 2000						
SUNDAY	MONDAY	TUESDAY	WEDNESDAY	THURSDAY	FRIDAY	SATURDAY
1	2	3	4	5	6	7
8	9	10	11	12	13	14
15	16	17	18	19	20	21
22	23	24	25	26	27	28
29	30	31				

Valley Stream Council of PTA's Elected Officers

President: Anne Marie Konzet 825-2572
 Vice President: Cathy Rotkowitz 599-1637
 Legislation: Mary Sheffield 285-6221
 Scholarship: Cathy Dalto 887-9572
 Treasurer: Sue McKeefery 596-0393
 Rec. Secretary: Marie Lawlor 791-3067
 Correspond. Secty.: Ann Marie Costiglio 791-1799
 Past President:

AUGUST 2000						
SUNDAY	MONDAY	TUESDAY	WEDNESDAY	THURSDAY	FRIDAY	SATURDAY
1	2	3	4	5		
6	7	8	9	10	11	12
13	14	15	16	17	18	19
20	21	22	23	24	25	26
27	28	29	30	31		

SEPTEMBER 2000

August
 Su M Tu W Th F Sa
 6 7 8 9 10 11 12 19
 13 14 15 16 17 18 26
 20 21 22 23 24 25 27
 28 29 30 31

October
 Su M Tu W Th F Sa
 1 2 3 4 5 6 7
 8 9 10 11 12 13 14
 15 16 17 18 19 20 21
 22 23 24 25 26 27 28
 29 30 31

SUNDAY	MONDAY	TUESDAY	WEDNESDAY	THURSDAY	FRIDAY	SATURDAY
3	4	5	6	7	8	9
10	11	12	13	14	15	16
17	18	19	20	21	22	23
24	25	26	27	28	29	30



Valley Stream

Union Free School District #30



2000-2001 Calendar

BOARD OF EDUCATION



Standing (left to right): *Trustee Andrew Walters, Trustee Maria Fletcher, Superintendent of Schools Lawrence R. McGoldrick and Vice President William Gauger.

Seated (left to right): *Trustee Leanore Egan and *President Richard Eisenberg.

* Also Serves on the High School Board

VALLEY STREAM DISTRICT 30

Vision

Valley Stream School District 30 is dedicated to maximizing the potential of our children and helping them discover the joy of learning.

Mission

The mission of Valley Stream School District 30, through collaboration with parents and community partners, is to educate all students to their highest levels of performance in nurturing learning environments that are safe, inclusive, and student centered.

Beliefs

WE BELIEVE THAT:

Every child can learn.

A child who experiences success will develop greater self-esteem.

Diversity should be embraced, appreciated, and respected.

Children should be encouraged to think creatively and work cooperatively.

Student needs determine instructional delivery.

Individuals should be accountable for their performance and behavior.

All community members are partners who share the responsibility of educating our children.

WE BELIEVE THAT WE MUST:

Create safe, caring and challenging learning environments.

Prepare each child to meet the challenges of the 21st Century.

Promote life-long learning.

Encourage active family and community involvement.

Provide appropriate resources and utilize innovative technology to assure success for each student.

Implement an integrated curriculum that is developmentally sequential from grade to grade.

Encourage and model honesty, integrity, and respect.

These vision, mission, and belief statements were created by the District 30 Comprehensive District Education Plan (CDEP) Committee during the 1999-2000 school year through a collaborative process. The Committee was composed of parents, teachers, administrators, and educational consultants.

SCHOOL ADMINISTRATION

DR. JERRY W. SHIVELEY
BOCES District Superintendent

LAWRENCE R. MCGOLDRICK
Superintendent of Schools

GENE NYITRAY
Assistant Superintendent of Schools

HELEN C. DESILVA
Assistant to the Superintendent for Business

HARRIET RABINOWITZ
Special Administrator, Education

SCHOOL PRINCIPALS
Clear Stream Avenue
Mr. Robert A. Cohen

Forest Road School
Mrs. Carol Kingsley

Shaw Avenue
Mr. Henry Mazer – Principal
Mrs. Elizabeth Trencheny – Assistant Principal

DIRECTOR OF FACILITIES
Gregory Abbate

SECRETARY TO SUPERINTENDENT
Madelaine Furst

SCHOOL SECRETARIES
Doreen Imbriani, Clear Stream Avenue
Angela Nicolini, Forest Road,
Daryl Rossello, Shaw Avenue

EDUCATIONAL OFFICE PERSONNEL
Marilyn Berkowitz
Carol Blankshine
Elaine Faling
Mary Ellen Franzese
Ann O'Brien
Annette Rosa-McDonald
Kathy Scuderi

SCHOOL NURSES
Forest Road
Sally Kaplan

Clear Stream Avenue
Alyce Gardner

Shaw Avenue
Sue Lombardo

OFFICE OF SPECIAL SERVICES

The Office of Special Services and Programs for Valley Stream Union Free School District 30 is committed to providing challenging and successful educational experiences for all students. How students meet these challenges and experience success will differ from student to student. The Office of Special Services and Programs is responsible for coordinating and providing various district-wide support services that promote school success for all students in an encouraging and welcoming environment. Included in these activities are standardized testing, English as a Second Language, Gifted and Talented Education, Speech and Language Remediation, Psychological Services, Health Screening and Special Education Services.

The Office of Special Services has the responsibility to provide appropriate support for students with disabilities in the least restrictive environment. Through the Committee on Special Education (CSE), students are assessed to determine eligibility for special education services. The Committee on Pre-school Special Education (CPSE) identifies a child found to be an eligible "pre-school child with a disability." Parents who suspect that their pre-school child has a developmental delay or disability that may be affecting his or her learning are encouraged to contact the Special Education Administrator for information about pre-school special education services available for eligible children.

Valley Stream U.F.S.D. 30 will provide appropriate special education services and programs through individualized planning and programming. Appropriate special education services and programs to meet each child's individual needs are determined collaboratively with school personnel, parents and community agencies at a CSE/CPSE review meeting. The recommended services and programs to meet each child's individual needs are incorporated into the student's Individual Educational Plan (IEP).

Valley Stream U.F.S.D. 30 provides a full continuum of special education and related services. These services can be provided in the general education classroom, resource room or special education classes within the district as well as appropriate settings outside the district. The related services include speech/language therapy, counseling, occupational therapy and physical therapy. The Learning Center (LC) Classes provide instruction in smaller student/teacher ratio with appropriate mainstreaming opportunities into the regular education classes. Students whose unique needs cannot be accommodated within the district may benefit from placement in out-of-district classes in neighboring school districts, BOCES (Board of Cooperative Education Services), or other private facilities. Valley Stream U.F.S.D. 30 strives to educate each child in the least restrictive environment. Programs are designed to allow students to be integrated with their non-disabled peers to the maximum extent appropriate.

Valley Stream U.F.S.D. 30 also provides services to eligible students as specified by Section 504 of the Rehabilitation Act of 1973.

The Office of Special Services and Programs is located at the Administration Building, 150 Washington Avenue. The telephone number is 285-9820.

Elaine Faling CSE/CPSE Secretary

Harriet Rabinowitz Special Education Administrator, CSE/CPSE Administrator, Section 504 Coordinator

SCHOOL TELEPHONE DIRECTORY

MAIN OFFICE: WASHINGTON

AVENUE SCHOOL

Superintendent285-9881
 Business Office285-9880
 Curriculum Office285-9833
 Superintendent FAX285-9839
 Washington Avenue FAX ... 285-8742

Committee for Special Education,

Chairperson285-9820
 Sp. Ed. Parent Members:
 Melissa Gates791-2516
 Petra Hurney561-7558
 Carolyn Lopardo568-0355
 Iris Pinnaro285-8236
 Mr. Winston Yarde285-6567

CLEAR STREAM

AVENUE SCHOOL

Principal's Office872-4333
 Nurse's Office872-4336
 FAX872-1205

FOREST ROAD SCHOOL

Principal's Office791-6134
 Nurse's Office791-6790
 FAX792-2931

SHAW AVENUE SCHOOL

Principal's Office872-4320
 Nurse's Office872-4327
 FAX568-2436

SPECIAL SERVICES

Computer Coordinator/AC Consultant
872-4342

INDEX

Board of EducationPage 2
 District StaffPage 4
 Special Services and Programs ..Page 5
 General InformationPage 6
 Weather ClosingsPage 7
 School PoliciesPages 7-10
 Clear Stream PTAPage 11
 Shaw Avenue PTAPage 12
 Forest Road PTAPage 13-14
 Monthly Calendars Pages 15 - 27
 Valley Stream Council
 of PTAs & SEPTAPage 14

VALLEY STREAM SCHOOL DISTRICT NO. 30 AND VALLEY STREAM CENTRAL HIGH SCHOOL DISTRICT VALLEY STREAM, NEW YORK

DISTRICT NO. 30 HIGH SCHOOLS	SECONDARY SCHOOLS	1
Shaw Avenue	North High	2
Clear Stream Avenue	Memorial Jr. High	3
Forest Road	Central High	4
Washington Avenue (District Office)	South High	

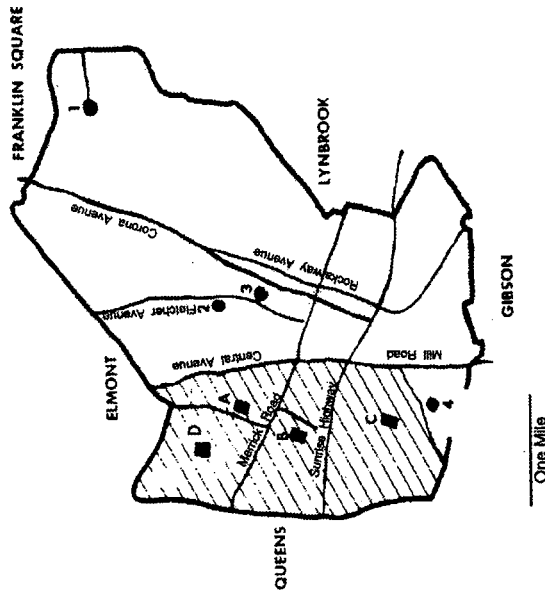

Calendar Preparation

Carol Kingsley
 Angela Nicolini
Cover Design

Dina-Marie Cuccia, Syntax Communication Group

SCHOOL POLICIES

VANDALISM

Vandalism costs money. Help us to reduce this drain on our tax dollars by keeping a watchful eye on your local school. Perhaps you have noticed persons on school grounds who were behaving suspiciously or actually engaged in vandalism, but you have not known where to call.

To report school vandalism or suspicious activities at your school, call the Nassau County Emergency Number 911. Give the name of the school, its location, and a brief description of what is happening. A police car will be radio-dispatched to investigate, and appropriate school personnel will be alerted. School officials will prosecute offenders whenever possible and attempt to secure restitution for damages.

PLEASE REPORT ANY OF THESE ACTIVITIES:

- Persons on the roof of the school
- Anyone throwing objects at windows
- Someone shooting weapons of any kind
- Any kind of fire on school grounds
- Destruction of grounds, shrubbery, or facility
- Anyone operating mini-bikes on playgrounds or driveway
- Any other suspicious or criminal acts

USE OF SCHOOL FACILITIES

The Board of Education encourages the use of school facilities for community purposes when

such use does not interfere with the scheduled school program. Organizations desiring to use school facilities should request an "Application for the Use of School Facilities" form from the principal of the school involved. Administrative rules and a statement of costs are explained on the application form.

SCHOOL VISITS

Parents are encouraged to visit our schools to meet the members of the professional staff, to examine the facilities and instructional programs, and to share ideas. Those wishing to observe classes or to meet with staff members should arrange the visit in advance so that the time is appropriate and does not interfere with planned activities.

All visitors must register at the school office upon arrival, before visiting other parts of the building.

At dismissal times, parents picking up students are requested to meet them at a previously designated spot outside of the school. Dismissal exits have been assigned to classes in each building. Students are expected to leave the school building and school property in an orderly fashion at dismissal time each day. Such procedures are necessary to ensure the safety of all students.

SCHOOL CLOSINGS OR DELAYED OPENINGS

Weather and other emergencies may warrant school closings or delayed openings. A delayed opening means students are expected to be at school at 10 a.m. PTA Class Parents will be informed and will initiate telephone calls to inform parents in each class. NEWS 12 on Channel 12 will carry school closing information. Such school closings or delays will also be announced on the following local radio stations:

WCBS (AM) 88	WGSM (AM) 740
WINS (AM) 1010	WALK (AM) 1370
WGBB (AM) 1240	WHLI (AM) 1100
WALK (FM) 97.5	

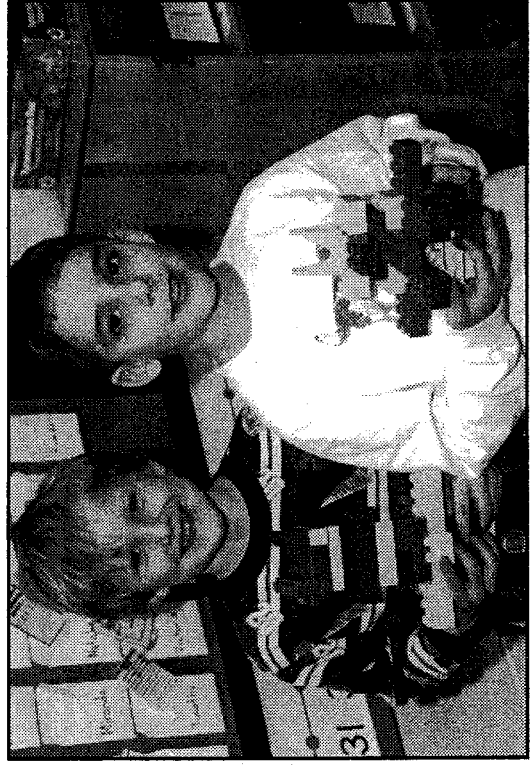

SCHOOL POLICIES

SCHOOL HOURS FOR ALL SCHOOLS

Kindergarten to Grade 6, including Special Classes: 8:30 a.m. to 2:45 p.m. Check with your school regarding availability of supervision for students who arrive before 8:20 a.m.

BREAKFAST

Students participating in the District Breakfast Program should not arrive before 7:40 a.m. Supervision is not provided for students prior to that time.

LUNCH

Lunch is served beginning on the first day of school. Pupils may go home for lunch, bring lunch from home, or buy the school lunch in the cafeteria. Students are not permitted to leave school for lunch unless picked up by a parent or authorized adult. Monthly menus are provided. In case a child forgets or loses his/her lunch money, there is a charge system to cover the emergency. The cafeteria keeps the record of such charges and contacts the parents should a charge not be paid in a reasonable time.

Students may purchase prepaid lunch tickets. Each ticket provides 20 meals, and is valid until June, or until all 20 meals are used. All tickets will remain with the Cafeteria Cashier.

SNACK MILK & JUICE

Snack milk & juice are sold to all children beginning the first day of school. You will be notified as to the exact date for payment. In case of a child's absence, no refund is made for a period of less than a full week.

ABSENCES

When your child has been absent, State law requires that he/she bring a note from you explaining the absences and the date(s) of absence(s). The note should be presented to the nurse before he/she goes to the classroom. Please be specific. Just saying, "he/she was ill, is not enough. Indicate whether it was "virus", "fever", "cold", etc.

A note is required for an absence due to a religious holiday. A note is required for any tardiness, giving the reason. If your child contracts a contagious disease, such as mumps, measles, etc., please phone the school nurse so that she can alert the parents in your child's class that their children may have been exposed. Be sure to keep the emergency card up to date so that we will know whom to call should your child become ill and have to go home.

NOON HOUR RULES

Students who repeatedly misbehave in the cafeteria, auditorium, or on the playground during the noon hour, may be excluded from staying in

school for lunch for a few days. If you receive such a note from the principal/teacher, we would appreciate your cooperation. Whether or not a parent is home during the noon hour has no bearing on this exclusion.

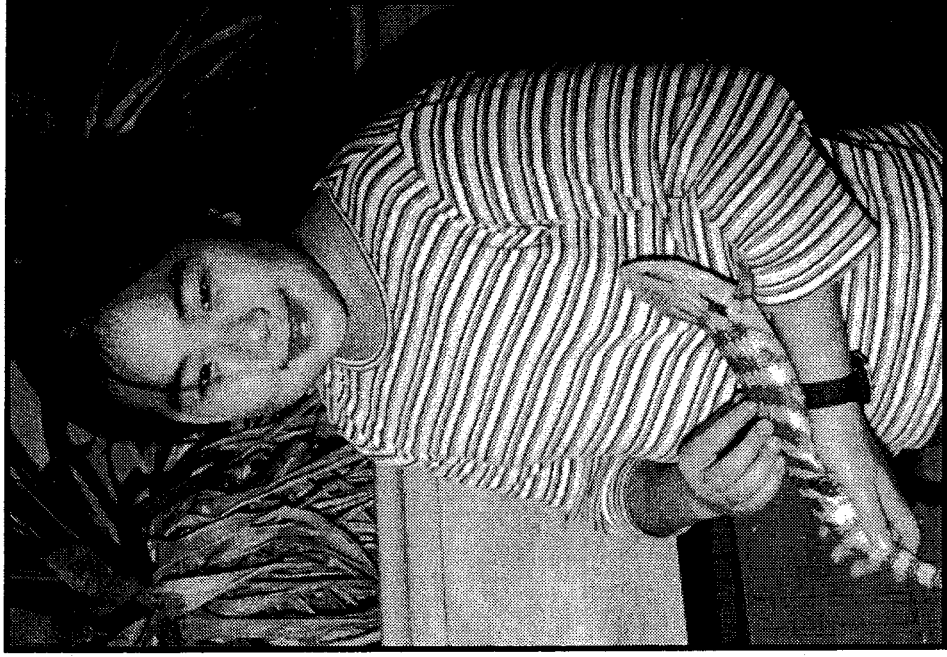

SCHOOL POLICIES

EXITS AND ENTRANCES

Your child's class is assigned a specific exit and entrance to use. You will thus know where to meet him/her when you come to pick up. Parents picking up children are asked to meet them at the exit, not the classroom. Parents must wait outside the school at dismissal time.

CLASS INTERRUPTIONS

No unnecessary interruptions of classes are allowed once the day's sessions have begun. When your child forgets a book, homework, sneakers, lunch, money, etc., please bring these to the office. All pupils are instructed to check with the office at lunch time for such forgotten items. In the interest of the child's all-around education, we urge you not to make a practice of bringing forgotten items to school. The child should be developing his/her own sense of responsibility for these things.

PHYSICAL EDUCATION ATTIRE AND SNEAKERS

Boys and girls are required to wear appropriate attire and sneakers on assigned gym days.

NO ONE IS ALLOWED ON THE GYM FLOOR WITHOUT SNEAKERS.

APPOINTMENTS WITH TEACHERS

In order that pupils' class time be used to the fullest advantage, we request that parents do not seek conferences with teachers during school hours. If you wish a conference, please make an appointment to see the teacher after school. Teachers are available for such conferences every day except Wednesdays and Fridays.

GIFTS TO TEACHERS PROHIBITED

The policy of the school district which became effective January 1956, is to prohibit the acceptance of gifts by faculty members on school premises, and to prohibit the solicitation of funds for personal gifts by faculty members on school premises, and to prohibit the solicitation of funds for personal gift purposes, by any person, or persons, on the premises.

BICYCLES

NO bicycles are allowed at either Forest Road or Clear Stream Avenue Schools because no child lives far enough from the school to make them necessary. They are allowed at Shaw, but are restricted to pupils in grades 4,5, and 6 who live NORTH OF FOSTER AVENUE. Bicycle operators must wear safety helmets. All must have a lock and chain for safety purposes.



SCHOOL POLICIES

IN-DAY PROGRAM

In inclement weather, there is an in-day program of motion pictures or quiet games provided for those pupils who eat in the cafeteria. Pupils who go home to lunch are not allowed to participate in this program because of space limitations, so we ask parents to return these pupils to school on such day just in time for the afternoon session—not before five minutes prior to their scheduled lunch time.

HOMEWORK REQUIREMENTS

Classroom learning is improved through effective homework assignments. Homework may include review, reinforcement, and reading in preparation for classroom discussion, analysis and research. Homework helps students establish work habits which will influence their use of time throughout life. Homework is required of all pupils, but it will vary from day to day. First and second grade pupils may have fifteen to twenty minutes of homework per day, while third and fourth grade pupils are likely to have thirty to forty minutes. Fifth and sixth graders are expected to devote as much as an hour to homework. Students should require little if any help from parents in completing assignments. However, parents may

assist students by ensuring that they have a quiet, comfortable place to work.

LOST AND FOUND

Unmarked articles lost by pupils are placed in the Lost-and-Found, which is in the Nurse's Office at Clear Stream, Shaw, and Forest. Such articles, if not claimed at the end of the school year, are given to a charitable organization. However, any article bearing a child's name is returned directly to him/her. Please place your child's name on all his/her belongings.

ASSEMBLIES

When your child's class puts on an assembly program, we welcome your attendance, but we do ask you not to bring preschool children. As much as we realize that it is a thrill for them to see older siblings perform, they are often distracting to all concerned. Picture-taking or video-taping are not allowed without prior approval.

MEDICATION

When it is necessary for a child

to take internal medication during school hours, the school nurse will cooperate with the family physician and the parents. The parent must submit a written request to the nurse with a written request from the family physician indicating the frequency and dosage of a prescribed medication. Then the nurse will administer this medication during the school hours. Under no circumstances will a child be permitted to carry or to take medication by himself or herself.

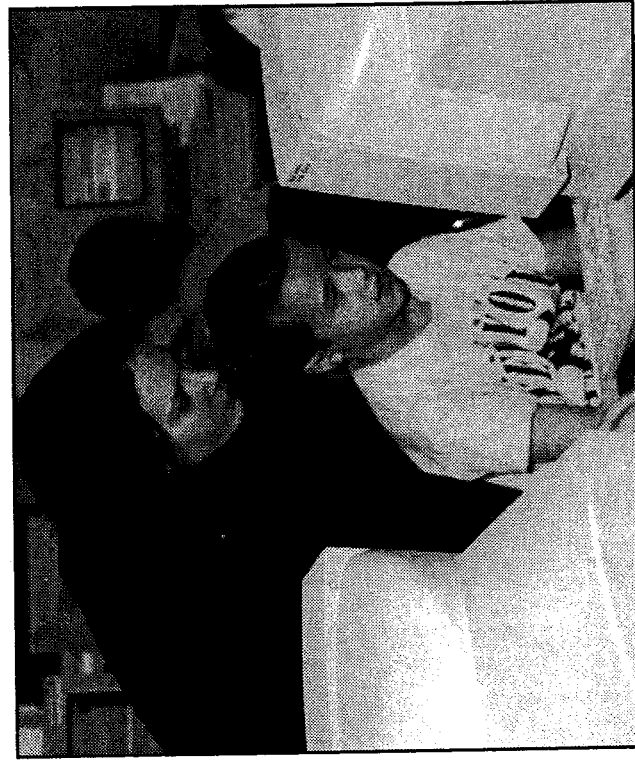

CLEAR STREAM PTA

ELECTED OFFICERS

Co-President	Marissa Makram	285-3574
Co-President	Patricia Raykowski	285-5675
1st VP-Programs	Judy Taliencio	561-3655
2nd VP-Preschool	Tina Cutrone	285-7051
3rd VP-Ways & Means	Marie Endrich	561-1906
Honorary Vice President	Robert A. Cohen	872-4333
Treasurer	Michele Hill	
Recording Secretary	Cathy Mule	872-2098
Corresponding Secretary	Grace Porti	872-9627
Membership	Jane Spezio	825-5762
Delegates to Council	Alice Swahn	285-8626
Teacher Delegate	Valerie Garcia	285-6639
	Mary Maclean	Faculty
Past President	Linda Pratt	Faculty
	Roseanne DiPalma	
	Maryanne Lanz	

EXECUTIVE BOARD STANDING COMMITTEE CHAIRPERSONS

Auditing	Marie Endrich	561-1906
	Barbara Schehr	872-1380
	Mary Breuer	285-4173
Banking	Greg Patton	285-0586
Birthday Calendar	Mary Maclean	Faculty
Cultural Arts	Joanne Novello	872-8229
	Carolyn Russo	561-5022
	Yvette Jones	285-7252
Hospitality	Paula Mercurio	823-1537
Legislation	To be announced	
Nutrition	To be announced	
Parent Awareness	To be announced	
Publicity/Historian	Cathy Mule	872-2098
Safety	Mirtho Denis	305-6683
School Sign	Nancy Seiter	568-9162
	Maryanne Valenti	825-0332

School and Community

SCOPE	To be announced	825-5029
SEPTA	James Johnson	285-0903
Streamer	Donna Hansen	
	To be announced	

SPECIAL COMMITTEE CHAIRPERSONS

Book Fair	Jeanne Mauro	285-3574
Breakfast w/Santa	Marissa Makram	872-1957
	Carol Green	285-7252
Candy Sale	Yvette Jones	285-1652
Cupcake Sale	Jeanie Amoroso	823-1537
	Paula Mercurio	
Fashion Show	Executive Board	
Father's Day Boutique	Tina Cutrone	285-7051
Fingerprinting	Mary Breuer	285-4173
	Jeanie Amoroso	285-1652
Holiday Boutique	Tina Cutrone	285-7051
Kids Night Out	Andrea Patton	285-0586
Parent/Child Night	Judy Taliencio	561-3655
PARP	Cathy Mule	872-2098
	Jane Spezio	825-5762
Pumpkin Patch	Nancy Seiter	568-9162
	Mary Breuer	285-4173
Plant Sale	Rosanna Schinco	561-4021
	Marissa Makram	285-3574
Reflections		
School Pictures	Maria Laudani	825-7649
	Carolyn Russo	561-5022
Staff Recognition	Grace Porti	872-9624
	Judy Taliencio	561-3655
Supermarket "Zingo"	Patricia Raykowski	285-5675
Volunteer Appreciation	Executive Board	

SHAW AVENUE PTA

ELECTED OFFICERS

Presidents
 1st Vice President
 2nd Vice President
 Honorary 1st Vice President
 Honorary 2nd Vice President
 Treasurer
 Assistant Treasurer
 Recording Secretary
 Corresponding Secretary
 Delegates To Council
 Teacher Delegate

Mary Aumuller
 Rosann Colucci
 Lisa Friscia
 Tara Starna
 Henry Mazer
 Elizabeth Trencheny
 Marybeth Cully
 Barbara Wilson
 Marianne Estevez
 Lynn Tranquellino
 Glenda Castoro
 Arlene LittleDawes
 Nancy Bart

285-0439
 561-3602
 256-0034
 561-3613
 Faculty
 Faculty
 285-2935
 568-2039
 285-3743
 561-0926
 825-3972
 285-7572
 Faculty

Field Day/Play Day T-Shirts
 Fingerprinting
 Fifty Anniversary Celebration
 Gift Wrap Sale
 Grade Reps Coordinator
 Holiday Boutique
 Hospitality
 Installation Dinner
 Junior Bowling
 Labels For Education
 Ladies Volleyball
 Membership
 Mother's Day Boutique
 Mother/Son Dance
 Newsletter
 New Parents Tea
 Nutrition
 PARP
 Public Relations
 Pumpkin Patch
 Reflections
 SCOPE
 School Picnic
 School Board Representative
 School Pictures
 SEPTA Representative
 Sixth Grade T-Shirts
 6th Grade Yearbook
 T-Shirt/Sweatshirt Sale
 Teacher/Staff Recognition

Marybeth Cully
 Donna Petrauskas
 Kathy Vagnone
 PTA Executive Board
 Barbara Wilson
 Kathy Vagnone
 Mary Napolionello
 Michael Antoniato
 Ralph Perrillo
 Debbie Sorace
 Lorraine Brooks
 Betty Acosta
 Betty Acosta
 Betty Acosta
 Mary Berman
 PTA Executive Board
 Arlene LittleDawes
 Donna Petrauskas
 Rosann Colucci
 Linda Pandolfi
 Marianne Estevez

825-2935
 561-3540
 825-3849

568-2039
 825-3849
 872-6388
 596-4457
 285-8979
 568-0254
 561-1902
 568-9820
 568-9820
 568-9820
 568-1479

COMMITTEE CHAIRPERSONS

Arts in Education
 Banking
 Birthday Calendar
 Book Fair (Fall)
 Book Fair (Spring)
 Breakfast with Santa
 Cupcake Sale
 Dance & Twirl Information
 Dance & Twirl Registration
 Family Fun Fair
 Fashion Show
 Father's Day Boutique
 Father/Daughter Dance
 Field Day/Play Day

Paul Farinacci
 Judy Post
 Tara Starna
 Kathy Vagnone
 Lynn Tranquellino
 Jean Adams
 Tara Starna
 Executive Board
 Barbara Wilson
 Joanne Zdanko
 Mary Aumuller
 PTA Executive Board
 PTA Executive Board
 Donna Petrauskas
 Linda Robles
 Donna Petrauskas
 Linda Robles
 Mary Aumuller

Faculty
 Faculty
 561-3613
 825-3849
 561-0926
 256-0971
 561-3613
 568-2039
 568-0498
 285-0439
 561-3540
 561-6591
 561-3540
 561-6591
 285-0439

285-7572
 561-3540
 561-3602
 285-8416
 285-3743
 360-0080
 285-5736
 256-0034
 872-1132
 561-7558
 285-8859
 872-1132
 568-1479
 825-2291
 285-0530
 872-1132

PTA Executive Board
 Chris Vessey
 Lisa Friscia
 Vivian Rainone
 Petra Hurney
 Karen DePalma
 Vivian Rainone
 Mary Berman
 Ginny Gregory
 MaryAnne VanVynck
 Vivian Rainone

FOREST ROAD PTA

ELECTED OFFICERS

Co-President
 Co-President
 1st Vice President Ways & Means
 2nd Vice President Programming
 3rd Honorary Vice President
 Treasurer
 Recording Secretary
 Financial Secretary
 Corresponding Secretary
 Teacher Representative
 Past President

Andrea Bretscher
 Julie Olson
 Brigitte La Porte
 Helene Steiner
 Carol Kingsley
 June Goldman
 Jill Cohen
 Helene Harris
 Maria Shea
 Kathy Maybaum
 Linda Kessler
 Elly Haber

791-2248
 792-9629
 791-6698
 791-2971
 791-6134
 791-2666
 791-3407
 791-8425
 791-1606
 791-7812
 791-6134
 791-1293

Banking Coordinators

Darlene Douglas

791-1782

Class Parent Coordinators

Debbie Longo

791-9030

Flyers/Historian

Wayne Burke

792-0287

Hospitality

Maria Shea

791-1606

Legislation

Jill Cohen

791-3407

Newsletter

Helene Harris

791-8425

Nutrition Representative

Mara Steindam

791-8502

Publicity

Lori Blitzer

791-3911

Safety

Executive Board

791-2248

School Board Representative

Melissa Gates

792-9629

Schoolship Committee

Julie Olson

791-2516

School Pictures

Grace Guttman

792-9629

SEPTA Representatives

Dina Ciullo

791-6134

6th Grade Yearbook

Andrea Bretscher

792-0216

Staff Recognition

Lori Blitzer

791-2248

Pumpkin Patch

Susan Nazinitsky

791-3911

Art Appreciation

Heidi Hass

791-4121

Helene Harris

792-0058

Helene Steiner

791-8425

Elly Haber

791-2971

Jill Cohen

791-1293

Helene Harris

791-3407

Helene Harris

791-8425

Petra Hurney

561-7558

Melissa Gates

791-2516

Julie Olson

792-9629

Elly Haber

791-1293

Tammy Weinstein

791-5870

Barbara Levy

791-1292

Andrea Bretscher

791-2248

Wendie Ciorciari

791-4266

Lisa Vogel

568-1901

Laura Feaser

791-5904

Marianne Tomasulo

791-2659

Sue Pepper

791-3889

Julie Olson

792-9629

Louise Edman

791-7331

EXECUTIVE BOARD COMMITTEE

CHAIRPERSONS

Fundraising

Chairperson
 Book Fair

Rochelle Gendelman

791-9146

Tammy Weinstein

791-5870

Barbary Levy

791-1292

Brigette La Porte

791-6698

Rochelle Gendelman

791-9146

Brigette La Porte

791-6698

Rochelle Gendelman

791-9146

Helene Steiner

791-2971

Helene Harris

791-8425

Barbara Levy

791-1292

Tammy Weinstein

791-5870

Annette Miller

791-2686

Meryl Merenstein

791-5782

Sue Pepper

791-3889

Annette Miller

791-2686

Robin Teramo

791-6322

Kathy Maybaum

791-7812

Rhonda Blum

791-8249

Ann Schindler

791-8707

Administrative Committees

Delegate to Council

FOREST ROAD PTA

Programming Committees
Committee Chairpersons
Field Day

Wendie Ciorciari 791-4266
 Andrea Bretscher 791-2248
 Brigitte La Porte 791-6698
 Dina Ciullo 792-0216
 Jill Cohen 791-3407
 Maria Shea 791-1606
 Louise Edman 791-7331
 Sue Pepper 791-3889

Pre-School

Laura Feaser 791-5904
 Sue Pepper 791-3889
 Melissa Gates 791-2516
 Robin Teramo 791-6322
 Julie Olson 792-9629
 Helene Harris 791-8425
 Elly Haber 791-1293
 Wendie Ciorciari 791-4266
 Helene Steiner 791-2971

Reflections

Sports Night

PARP

SEPTA • COUNCIL OF PTAS

VALLEY STREAM OFFICERS FOR 2000-2001

Co-Presidents	Annette Senicola 481-7716 Patricia Hayes 872-3062
Vice Presidents	Rose Barbaro 561-8018
Distribution	Melissa Gates 791-2516
Membership	Joanne Cammalleri 825-1668
Correspondence	Josephine Centore 485-6411
Treasurer	Petra Hurney 561-7558
Recording Secretary	To be announced
Delegate to Council	Joanne Altrui 488-4255
Delegate to SEPTA/BOCES	

VALLEY STREAM COUNCIL OF PTAS ELECTED OFFICERS

President	Anne Marie Konzet 825-2572
Vice Presidents	Mary Sheffield 285-6221 Elena Gelbart 872-0299
Scholarship	Petra Hurney 561-7558
Treasurer	Ann Marie Costiglio 791-1799
Corresponding Secretary	
Past President	

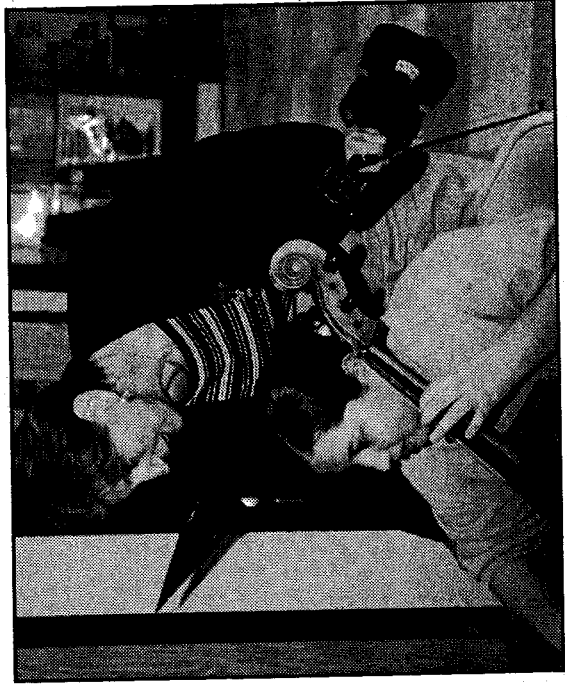

September 2000

Sunday

Monday

Tuesday

Wednesday

Thursday

Friday

Saturday

1 2

3	4	5	6	7	8	9
10	11	12	13	14	15	16
17	18	19	20	21	22	23
24	25	26	27	28	29	30

3 Labor Day
Schools Closed

4 Superintendent's Conference Day
No School for Students
Valley Stream Central HS District Board of Education Comm. Mtg., 8:00 p.m.

5 School Opens
Clear Stream Avenue Coffee, Tea & Tears, 8:30 a.m. (Kindergarten Parents)

6 Shaw Avenue New Parents Tea, 8:30-11:00 a.m.
Shaw Avenue 50th Anniversary Re-Dedication

7 Shaw Avenue Jr. Bowling Reg., 2:45 p.m.
Clear Stream Avenue, Shaw Avenue & Forest Road Meet the Teacher Night, 7:30 p.m.

8 Forest Road PTA New Parents Breakfast, 9:00 a.m.

9 Forest Road PTA Ex. Bd. Meeting, 8:30 a.m.
Valley Stream Central HS District Board of Education Business Mtg., 8:30 p.m.

10 Forest Road PTA Class Parents Mtg., 7:00 p.m., General Mtg., 7:30 p.m.
Clear Stream Avenue PTA Class Parents Mtg., 7:30 p.m., General Mtg., 8:00 p.m.

11 Forest Road PTA Banking Begins
Shaw Avenue PTA Mtg., 8:00 p.m.
Nassau District Legislation Town Mtg.

12 Forest Road PTA Class Parents Mtg., 7:00 p.m., General Mtg., 7:30 p.m.
Clear Stream Avenue PTA Class Parents Mtg., 7:30 p.m., General Mtg., 8:00 p.m.

13 Forest Road PTA Banking Begins
Shaw Avenue PTA Mtg., 8:00 p.m.
Nassau District Legislation Town Mtg.

14 Forest Road PTA Class Parents Mtg., 7:00 p.m., General Mtg., 7:30 p.m.
Clear Stream Avenue PTA Class Parents Mtg., 7:30 p.m., General Mtg., 8:00 p.m.

15 Forest Road PTA Class Parents Mtg., 7:00 p.m., General Mtg., 7:30 p.m.
Clear Stream Avenue PTA Class Parents Mtg., 7:30 p.m., General Mtg., 8:00 p.m.

16 Forest Road PTA Class Parents Mtg., 7:00 p.m., General Mtg., 7:30 p.m.
Clear Stream Avenue PTA Class Parents Mtg., 7:30 p.m., General Mtg., 8:00 p.m.

17 District 30 Board of Education Comm. Mtg., 8:00 p.m.

18 District 30 Board of Education Mtg., 8:00 p.m.

19 District 30 Board of Education Mtg., 8:00 p.m.

20 District 30 Board of Education Mtg., 8:00 p.m.

21 District 30 Board of Education Mtg., 8:00 p.m.

22 District 30 Board of Education Mtg., 8:00 p.m.

23 District 30 Board of Education Mtg., 8:00 p.m.

24 District 30 Board of Education Mtg., 8:00 p.m.

25 District 30 Board of Education Mtg., 8:00 p.m.

26 District 30 Board of Education Mtg., 8:00 p.m.

27 District 30 Board of Education Mtg., 8:00 p.m.

28 District 30 Board of Education Mtg., 8:00 p.m.

29 District 30 Board of Education Mtg., 8:00 p.m.

30 District 30 Board of Education Mtg., 8:00 p.m.

AUGUST 2000

S	M	T	W	T	F	S
1	2	3	4	5	6	7
8	9	10	11	12	13	14
15	16	17	18	19	20	21
22	23	24	25	26	27	28
29	30	31				

OCTOBER 2000

S	M	T	W	T	F	S
1	2	3	4	5	6	7
8	9	10	11	12	13	14
15	16	17	18	19	20	21
22	23	24	25	26	27	28
29	30	31				

October 2000

Sunday Monday Tuesday Wednesday Thursday Friday Saturday

1	2	3	4	5	6	7
	PTA Council Mtg., Willow Road, 7:30 p.m.	Valley Stream Central HS District Board of Education Comm. Mtg., 8:00 p.m.				
8	9	10	11	12	13	14
	Columbus Day Yom Kippur Schools Closed	Forest Road PTA Ex Bd Mtg., 8:30 a.m. Clear Stream Candy & Wrap Sales End Valley Stream Central HS District Board of Education Business Mtg., 8:30 p.m.	Shaw Avenue School Pictures	Shaw Avenue Banking Reg. Begins	Forest Road PTA Picture Day Clear Stream Avenue Cupcake Sale Breakfast w/ the Superintendent at Forest Road, 8:30 a.m.	Village of Valley Stream 75th Anniversary Parade, 10:00 a.m.
15	16	17	18	19	20	21
	Valley Stream SEPTA Meeting, Memorial JHS, 8 p.m. District 30 Board of Education Comm. Mtg., 8:00 p.m.		Forest Road PTA Gen. Mtg., 7:30 p.m. Clear Stream Avenue PTA Ex. Bd. Meeting, 7:00 p.m./Gen., 7:30 p.m. Shaw Avenue Candy/Gift Sale Ends	Shaw Avenue Banking Reg. Ends Shaw Avenue PTA Mtg., 8:00 p.m.	Clear Stream Avenue School Pictures Clear Stream Avenue Movie Night (K-2), 7:30 p.m.	Village of Valley Stream 75th Anniversary Parade, 10:00 a.m. (Rain Date)
22	23	24	25	26	27	28
	District 30 Board of Education Mtg., 8:00 p.m.				Shaw Avenue Kindergarten Pumpkin Patch Forest Road PTA Pumpkin Patch Clear Stream Avenue Halloween Party, Gr. 5 & 6, 5:30-7:30 p.m. Shaw Avenue Finger Painting	
29	30	31				
Daylight Savings Time Ends		Halloween Forest Road 6th Grade Halloween Party, 5:30-7:30 p.m. Shaw Avenue 50's Halloween			Clear Stream Pumpkin Patch, 9 a.m.-2:30 p.m.	

SEPTEMBER 2000
S M T W T F S

	1	2				
3	4	5	6	7	8	9
10	11	12	13	14	15	16
17	18	19	20	21	22	23
24	25	26	27	28	29	30

NOVEMBER 2000
S M T W T F S

	1	2	3	4		
5	6	7	8	9	10	11
12	13	14	15	16	17	18
19	20	21	22	23	24	25
26	27	28	29	30		

November 2000



Sunday **Monday** **Tuesday** **Wednesday** **Thursday** **Friday** **Saturday**

5	6	7	8	9	10	11
PTA Council Ex. Comm. Mtg., 7:30 p.m.	Election Day (Voting at All Schools, 5:30 a.m.-9:00 p.m.) Superintendents Conference Day No School for Students Valley Stream Central HS District Board of Education Comm. Mtg., 8:00 p.m.	Clear Stream Avenue PTA, Gen. Mtg., 8:45 a.m.	Forest Road PTA Fashion Show, 7:30 p.m.	Veterans' Day (Observed) Schools Closed	Veterans' Day	Veterans' Day
12	13	14	15	16	17	18
SEPTA Meeting at Memorial JHS, 8:00 p.m. Valley Stream Central HS Board of Education Business Mtg., 8:30 p.m.	Forest Road PTA, Ex. Bd. Mtg., 8:30 a.m.	Clear Stream Avenue PTA, Gen. Mtg. for Kindergarten 2001/2002, 1:30 p.m. Shaw Banking, 7:45-8:15 a.m. Shaw PTA Mtg., 8:00 p.m.	Clear Stream Avenue Book Fair	NYS PTA Connection	Clear Stream Avenue Movie Night (Gr. 3-6), 7:30 p.m.	District 30 Building Inspection (Tentative)
19	20	21	22	23	24	25
District 30 Board of Education Mtg., 8:00 p.m.	Shaw Avenue 50th Anniversary Assembly, 1:00 & 7:00 p.m.	Forest Road Thanksgiving Breakfast, 8:30 a.m. Shaw Avenue Picture Retake	Thanksgiving	Thanksgiving	Thanksgiving	Thanksgiving
26	27	28	29	30		
District 30 Board of Education Mtg., 8:00 p.m.	Forest Road Picture Retake Day	Forest Road PTA Gen. Mtg., 7:30 p.m.	Clear Stream Avenue Picture Retake	Clear Stream Avenue Picture Retake		

OCTOBER 2000

S	M	T	W	T	F	S
1	2	3	4	5	6	7
8	9	10	11	12	13	14
15	16	17	18	19	20	21
22	23	24	25	26	27	28
29	30	31				

DECEMBER 2000

S	M	T	W	T	F	S
		1	2			
3	4	5	6	7	8	9
10	11	12	13	14	15	16
17	18	19	20	21	22	23
24	25	26	27	28	29	30

Clear Stream Ave. Gr. 6 Outdoor Ed Program

Shaw Avenue Gr.6 Outdoor Education Program

Thanksgiving Recess Schools Closed

Forest Road Reflections After School Workshops
American Education Week

December 2000

Sunday

Monday

Tuesday

Wednesday

Thursday

Friday

Saturday

3	4	5	6	7	8	9
10	11	12	13	14	15	16
17	18	19	20	21	22	23
24	25	26	27	28	29	30

Valley Stream Central
HS District Building
Inspection, 8:00 a.m.

Shaw Avenue
Breakfast w/ Santa
Ticket Sale, 2:30 p.m.

**Clear Stream Gr.
6 Outdoor Ed
Program**

Clear Stream Avenue
Breakfast w/ Santa,
10:00 a.m.-12:00 p.m.

Forest Road PTA
Reflections Ends

Shaw Ave. PTA Holiday Boutique

Forest Rd. Gr. 6 Outdoor Education Program

Shaw Avenue
Breakfast w/ Santa,
10:00 a.m.-12:00 p.m.

Shaw Avenue
Reflections Ends
Clear Stream Avenue
Winter Concert,
7:30 p.m.

Forest Rd. PTA Holiday Boutique
Clear Stream PTA Holiday Boutique

Chantukah
Holiday Recess
Begins

Clear Stream Avenue
Movie Night (K-6),
7:30 p.m.

Shaw Avenue 50th
Anniversary Time
Capsule Ceremony

Shaw Avenue Banking,
7:45-8:15 a.m.

Clear Stream Avenue
Reflections Begins

District 30 Board of
Education Mtg.,
8:00 p.m.

Christmas Day

Holiday Recess Schools Closed

NOVEMBER 2000

S	M	T	W	T	F	S
	1	2	3	4		
5	6	7	8	9	10	11
12	13	14	15	16	17	18
19	20	21	22	23	24	25
26	27	28	29	30		

JANUARY 2001

S	M	T	W	T	F	S
	1	2	3	4	5	6
7	8	9	10	11	12	13
14	15	16	17	18	19	20
21	22	23	24	25	26	27
28	29	30	31			

January 2001

Sunday

Monday

Tuesday

Wednesday

Thursday

Friday

Saturday

	1 New Year's Day Schools Closed	2 Schools Reopen Shaw Avenue 50's Essay Contest Begins Valley Stream Central HS District Board of Education Comm. Mtg., 8:00 p.m.	3 Shaw Avenue Banking, 7:45-8:15 a.m.	4	5 Breakfast w/ Superintendent at Clear Stream Avenue, 8:30 a.m.	6
7	8 PTA Council Ex. Comm. Mtg., 7:30 p.m.	9 Forest Road PTA Ex. Bd. Mtg., 8:30 a.m. Clear Stream Avenue Reflections Ends Valley Stream Central HS District Board of Education Business Mtg., 8:30 p.m.	10 Clear Stream Avenue PTA Ex. Bd. Mtg., 7:00 p.m. Gen. Mtg., 7:30 p.m. Nassau District PTA Nominations/Elections Workshop	11	12	13
14 All County Elementary Music Festival at C.W. Post Tilles Center	15 Dr. Martin Luther King, Jr. Day Schools Closed	16	17 Shaw Avenue Banking, 7:45 -8:15 a.m. Shaw Avenue PTA Mtg. Shaw Avenue Reflections Awards Ceremony, 8:00 p.m.	18	19	20 Shaw Avenue 50 cent Movie Day
21	22 Clear Stream Avenue "Super Snack" Sale Begins District 30 Board of Education Comm. Mtg., 8:00 p.m.	23 Forest Road PTA PARP Begins	24	25 Forest Road Gen. Mtg., 8:30 a.m. Shaw Avenue Cupcake Sale	26 Clear Stream Avenue Supermarket "Sweep," 7:30 p.m.	27
28	29 District 30 Board of Education Mtg., 8:00 p.m.	30	31 Forest Road PTA PARP Night, Grades 1-3	Forest Road Book Fair		

NYS Grade 4 ELA Test

DECEMBER 2000
S M T W T F S

	1	2				
3	4	5	6	7	8	9
10	11	12	13	14	15	16
17	18	19	20	21	22	23
24	25	26	27	28	29	30

FEBRUARY 2001
S M T W T F S

	1	2	3			
4	5	6	7	8	9	10
11	12	13	14	15	16	17
18	19	20	21	22	23	24
25	26	27	28			

February 2001

Sunday

Monday

Tuesday

Wednesday

Thursday

Friday

Saturday

4	5	6	7	8	9	10
11	12	13	14	15	16	17
18	19	20	21	22	23	24
25	26	27	28			

Valley Stream Central
HS District Budget
Review, 8:30 a.m.

Clear Stream Avenue
"Super Snack" Sale Ends
Shaw Ave. 50's Essay
Contest Ends
Forest Rd. PTA Sports
Night, Gr. 4-6, 7:30 p.m.
Shaw Ave. Family Fun
Fair, 7:00-10:00 p.m.

NYS Grade 4 ELA Test

Shaw Avenue Mtg. for
Kindergarten
2001-2002,
3:00-4:00 p.m.

Clear Stream Avenue
PTA Gen Mtg.,
8:45 a.m.
Shaw Avenue Banking,
7:45-8:15 a.m.
Nassau District PTA
President's Rep

Forest Rd PTA PAPP
Ends
Valley Stream Central
HS District Board of
Education Comm. Mtg.,
8:00 p.m.

PTA Council Mtg. at
Shaw Avenue,
7:30 p.m.

Forest Road PTA Ex.
Board Mtg., 8:30 a.m.
Shaw Avenue PTA
Mtg., 8:00 p.m.
Valley Stream Central
HS District Board of
Education Business
Mtg., 8:30 p.m.

Lincoln's Birthday
SEPTA Mtg. at Mem.
JHS, 8:00 p.m.
District 30 Board of
Education Comm.
Mtg., 8:00 p.m.

Clear Stream Avenue
Movie Night (K-2),
7:30 p.m.
Shaw Avenue 50's
Essay Awards
Ceremony

PTA Founder's Day
at Forest Road,
7:30 p.m.

Washington's
Birthday

Winter Recess Schools Closed

Shaw Avenue PAPP
Begins
District 30 Board of
Education Mtg.,
8:00 p.m.

JANUARY 2001

S	M	T	W	T	F	S
1	2	3	4	5	6	
7	8	9	10	11	12	13
14	15	16	17	18	19	20
21	22	23	24	25	26	27
28	29	30	31			

MARCH 2001

S	M	T	W	T	F	S
	1	2	3			
4	5	6	7	8	9	10
11	12	13	14	15	16	17
18	19	20	21	22	23	24
25	26	27	28	29	30	31

March 2001



Sunday	Monday	Tuesday	Wednesday	Thursday	Friday	Saturday
4 NYS PTA Legislation, Education Conference in Albany	5 Clear Stream Avenue PAPP Begins PTA Council Ex. Mtg., 7:30 p.m.	6 Valley Stream Central HS District Board of Education Comm. Mtg., 8:00 p.m.	7 Clear Stream Avenue PTA Gen. Mtg., 7:15 p.m., Reflections Night, 8:00 p.m. Shaw Avenue Banking, 7:45-8:15 a.m.	8 Clear Stream Avenue Parent/Child Night, 7:00 p.m.	9 Clear Stream Avenue Parent/Child Night, 7:00 p.m.	10 Forest Road PTA Carnival, 11:00 a.m.-3:00 p.m. Nassau District PTA Legislation Brunch
11 LI String Festival, Grades 5 & 6 at Berner JHS in Massapequa, 3:00 p.m.	12 SEPTA Mtg. at Mem. JHS, 8:00 p.m.	13 Forest Road PTA Ex. Bd. Mtg., 8:30 a.m. Forest Rd. Mtg. for Kindergarten 2001-2002, 3:00-4:00 p.m. Shaw Avenue Spring Candy Sale Ends Valley Stream Central HS District Board of Ed. Business Mtg., 8:30 p.m.	14 Clear Stream Avenue Mtg., for Kindergarten 2001-2002, 1:30 p.m.	15 Forest Road PTA Election Mtg., 7:00 p.m./Chinese Auction, 7:30 p.m. Shaw Avenue PTA Mtg., 8:00 p.m. Shaw Ave. Mtg. for Kindergarten 2001-2002, 3:00-4:00 p.m.	16 PTA Council Legislative Breakfast, 9:30-11:30 a.m. at Mem. JHS	17 PTA Council Legislative Breakfast, 9:30-11:30 a.m. at Mem. JHS
18 District 30 Board of Education Comm. Mtg., 8:00 p.m.	19 District 30 Board of Education Comm. Mtg., 8:00 p.m.	20 Grade 6 Science Fair at Clear Stream Avenue, 7:30 p.m.	21 Grade 6 Science Fair at Forest Road, 7:30 p.m. Shaw Avenue Banking, 7:45-8:15 a.m.	22 Grade 6 Science Fair at Shaw Avenue, 7:30 p.m. Clear Stream Avenue Fashion Show, 7:30 p.m.	23 Breakfast w/ Superintendent at Shaw Avenue, 8:30 a.m.	24 Breakfast w/ Superintendent at Shaw Avenue, 8:30 a.m.
25 District 30 Board of Education Mtg., 8:00 p.m.	26 District 30 Board of Education Mtg., 8:00 p.m.	27 NYSSMA Solo Festival	28 NYSSMA Solo Festival	29 Shaw Avenue Fashion Show, 7:00 p.m.	30 Clear Stream Avenue Spring Concert, 7:30 p.m. Clear Stream PAPP Ends	31 Clear Stream Avenue Spring Concert, 7:30 p.m. Clear Stream PAPP Ends

FEBRUARY 2001

S	M	T	W	T	F	S
	1	2	3			
4	5	6	7	8	9	10
11	12	13	14	15	16	17
18	19	20	21	22	23	24
25	26	27	28			

APRIL 2001

S	M	T	W	T	F	S
1	2	3	4	5	6	7
8	9	10	11	12	13	14
15	16	17	18	19	20	21
22	23	24	25	26	27	28
29	30					

April 2001



Saturday

Friday

Thursday

Wednesday

Tuesday

Monday

Sunday

1	2	3	4	5	6	7	
Daylight Savings Time Begins	Shaw Avenue PAPP Ends PTA Council Mtg. at Wheeler Avenue, 7:30 p.m.	Forest Road PTA Ex. Bd. Mtg., 8:30 a.m. Forest Road Spring Concert, 7:30 p.m. Valley Stream Central HS District Board of Education Comm. Mtg., 8:00 p.m.	Shaw Avenue Banking, 7:45 a.m.-8:15 a.m. Shaw Avenue Spring Concert, 7:30 p.m.	Clear Stream Avenue PTA Gen. Mtg., 7:15 p.m.	Clear Stream Avenue Kids Night Out, 7:00 p.m.		
8	9	10	11	12	13	14	
Spring Recess - Schools Closed							
15	16	17	18	19	20	21	
Last Day of Spring Recess Schools Closed Deadline for Petitions for Trustee, 5:00 p.m.	Schools Reopen Valley Stream Central HS District Board of Education Business Mtg., 8:30 p.m. District 30 Board of Education Comm. Mtg., 8:00 p.m.	Schools Reopen Valley Stream Central HS District Board of Education Business Mtg., 8:30 p.m. District 30 Board of Education Comm. Mtg., 8:00 p.m.	Forest Road PTA Gen. Mtg., 7:30 p.m. Shaw Avenue Banking, 7:45-8:15 a.m.	Shaw Avenue PTA Mtg., 8:00 p.m.			
22	23	24	25	26	27	28	
Earth Day	SEPTA Mtg., Mem. JHS, 8:00 p.m.	BOCES Budget Vote, 7:00 p.m. w/ District 30 Board of Education Mtg. to Follow	Lights on for Education, Mem. JHS, 7:15-9:15 p.m.	Lights on for Education, Mem. JHS, 7:15-9:15 p.m.	Forest Road PTA Staff Spring Celebration Clear Stream Avenue Movie Night, Gr. 3-6, 7:30 p.m.		
29	30	Kindergarten Registration at All Schools 9-11 a.m.					
	Valley Stream Central HS District Board of Education Comm. Mtg., 8:00 p.m.						

MARCH 2001

S	M	T	W	T	F	S
	1	2	3			
4	5	6	7	8	9	10
11	12	13	14	15	16	17
18	19	20	21	22	23	24
25	26	27	28	29	30	31

MAY 2001

S	M	T	W	T	F	S
	1	2	3	4	5	
6	7	8	9	10	11	12
13	14	15	16	17	18	19
20	21	22	23	24	25	26
27	28	29	30	31		

May 2001



Sunday **Monday** **Tuesday** **Wednesday** **Thursday** **Friday** **Saturday**

		1 Joint Central HS District Public Budget Hearing w/ District 30 at Clear Stream Avenue, 8:00 p.m.	2 Shaw Avenue Banking, 7:45-8:15 a.m. Joint Central HS District Public Budget Hearing w/ District 30 at Dever, 8:00 p.m.	3 Joint Central HS District Budget Hearing w District 24 at Buck, 8:15 p.m.	4 Shaw Avenue 50's Mother's Day Dance	5
6	7 PTA Council, 7:30 p.m., Ex. Comm. Mtg.	8 Forest Road PTA Ex. Bd. Mtg., 8:30 a.m. Valley Stream Central HS District Board of Education Business Mtg., 8:30 p.m. Clear Stream/Forest/Shaw Budget Voter Registration, 7-9 a.m. & 4-9 p.m. Clear Stream/Forest Mtg. for Kind. 2001-02, 7 p.m.	9 Forest Road PTA Plant, Pre-Order Pick-Up Clear Stream Avenue PTA Ex. Bd. Mtg., 7:00 p.m., Gen. Mtg., 7:30 p.m.	10 Shaw Avenue PTA Mtg., 8:00 p.m. Volunteer Night	11 Clear Stream Avenue PTA Plant Sale Shaw Avenue Mother's Day Boutique Tots to Teens Show at Central HS NYSSMA All-State & All-State Jazz at Lawrence HS	12
13 Mother's Day	14 SEPTA Mtg., Mem. JHS, 8:00 p.m. District 30 Board of Education Comm. Mtg., 8:00 p.m.	15 Budget Vote at Clear Stream/Forest/Shaw 7:00 a.m.-10:00 p.m. District Art Exhibit, 7:30 p.m. -9:00 p.m.	16 Shaw Avenue Banking Ends, 7:45-8:15 a.m.	17 Shaw Avenue Teachers Staff Recognition	18 Clear Stream Avenue Staff Recognition	19
	20	21 District 30 Board of Education Mtg., 8:00 p.m.	22 Forest Road PTA Ex. Bd./Scheduling Mtg., 8:30 a.m.	23 NYS Gr. 4 Mathematics Test	24 Clear Stream Avenue Talent Show, 7:00 p.m.	25 Memorial Day Recess Schools Closed
27	28 Memorial Day Observed Schools Closed Memorial Day Parade, 9:00 a.m.	29	30 Forest Road PTA Installation Dinner, 7:30 p.m. Clear Stream Avenue PTA Installation Dinner, 7:30 p.m.	31		26

APRIL 2001

S	M	T	W	T	F	S
1	2	3	4	5	6	7
8	9	10	11	12	13	14
15	16	17	18	19	20	21
22	23	24	25	26	27	28
29	30					

JUNE 2001

S	M	T	W	T	F	S
					1	2
3	4	5	6	7	8	9
10	11	12	13	14	15	16
17	18	19	20	21	22	23
24	25	26	27	28	29	30

June 2001

Sunday	Monday	Tuesday	Wednesday	Thursday	Friday	Saturday
					1 Shaw Avenue PTA Installation Dinner, 7:00 p.m.	2
3	4 PTA Council Mtg. at Central, 7:30 p.m.	5 Valley Stream Central HS District Board of Education Comm. Mtg., 8:00 p.m.	6 Clear Stream Avenue PTA Gen. Mtg., 8:45 a.m.	7	8 Forest Road PTA Family Picnic, 5:30-7:30 p.m.	9
10	11 SEPTA Mtg., Mem. JHS, 8:00 p.m.	12 Valley Stream Central HS District Board of Education Business Mtg., 8:30 p.m.	13 Shaw Avenue PTA Social, 7:00 p.m.	14 Flag Day	15 Clear Stream Ave. Father's Day Boutique Clear Stream Ave. Volunteer Appreciation Breakfast, 9 a.m. Shaw Ave. 50's Father's Day Dance Shaw Ave. Father's Day Boutique	16
17 Father's Day	18 District 30 Board of Education Comm. Mtg., 8:00 p.m.	19	20 Clear Stream/ Forest/Shaw Grade 6 Closing Exercises, 8:15 p.m.	21 Clear Stream/Forest Kindergarten Graduation, 9:00 a.m. Shaw Ave. Kindergarten Closing Exercises, 1:30 p.m. Shaw Avenue Picnic Clear Stream/ Forest Gr. 6 Graduation Parties, 1-3 p.m.	22 Last Day of School Early Dismissal 8:30-9:30 a.m.	23
24	25 District 30 Board of Education Mtg., 8:00 p.m.	26	27	28	29	30

MAY 2001

S	M	T	W	T	F	S
	1	2	3	4	5	
6	7	8	9	10	11	12
13	14	15	16	17	18	19
20	21	22	23	24	25	26
27	28	29	30	31		

JULY 2001

S	M	T	W	T	F	S
1	2	3	4	5	6	7
8	9	10	11	12	13	14
15	16	17	18	19	20	21
22	23	24	25	26	27	28
29	30	31				

July 2001



Sunday	Monday	Tuesday	Wednesday	Thursday	Friday	Saturday
1	2 Summer School Begins (Tentative)	3	4 Independence Day	5	6	7
8	9 Valley Stream Central HS District Board of Education Business & Reorganization Mtg., 7:30 p.m.	10	11	12	13	14
15	16	17	18	19	20	21
22	23	24	25	26	27	28
29	30	31				

August 2001

Sunday	Monday	Tuesday	Wednesday	Thursday	Friday	Saturday
			1	2	3	4
5	6	7	8	9	10	11
12	13	14	15	16	17	18
19	20	21 Valley Stream Central HS District Board of Education Business Mtg., 8:30 p.m.	22	23	24	25
26	27	28	29	30	31	



September 2001



Sunday	Monday	Tuesday	Wednesday	Thursday	Friday	Saturday
						1
2	3 Labor Day Schools Closed	4 Superintendent's Conference Day for Staff (Tentative) No School for Students (Tentative)	5 Schools Open (Tentative)	6	7	8
9	10	11	12	13	14	15
16	17	18 Rosh Hashanah Schools Closed	19 Rosh Hashanah Schools Closed	20	21	22
23	24	25	26	27 Yom Kippur Schools Closed	28	29

The Friendly Schools

Valley Stream #30

Public Schools

Valley Stream UFSD #30

Valley Stream, NY 11580-3032



Board of Education

Richard Eisenberg, President
William O. Gauger, Vice President
Leanore Egan, Member
Maria A. Fletcher, Member
Andrew J. Walters, Member

Superintendent of Schools
Lawrence R. McGoldrick